

MELSEC iQ-F Series
iQ Platform-compatible PLC



The next level of industry

MELSEC iQ-F
series

GLOBAL IMPACT OF MITSUBISHI ELECTRIC



Through Mitsubishi Electric's vision, "Changes for the Better" are possible for a brighter future.

Changes for the Better

"Changes for the Better" represents the Mitsubishi Electric Group's attitude to "always strive to achieve something better", as we continue to change and grow. Each one of us shares a strong will and passion to continuously aim for change, reinforcing our commitment to creating "an even better tomorrow".

Mitsubishi Electric is involved in many areas including the following:

Energy and Electric Systems

A wide range of power and electrical products from generators to large-scale displays.

Electronic Devices

A wide portfolio of cutting-edge semiconductor devices for systems and products.

Home Appliance

Dependable consumer products like air conditioners and home entertainment systems.

Information and Communication Systems

Commercial and consumer-centric equipment, products and systems.

Industrial Automation Systems

Maximizing productivity and efficiency with cutting-edge automation technology.

Our advances in AI and IoT are adding new value to society in diverse areas from automation to information systems. The creation of game-changing solutions is helping to transform the world, which is why we are honored to be recognized in the 2019 "Forbes Digital 100" as one of world's most influential digital corporations.



Concept

iQ Platform

“Connect” Factory Automation with iQ Platform

“iQ Platform”, a solution that integrates and cooperates with controllers, HMI, engineering environments, and networks at the production site, Mitsubishi Electric has proposed along with “e-F@ctory” that information-links the high-level information system (manufacturing execution system (MES)) and production site, will integrate and optimize your system with advanced technology to reduce development, production and maintenance costs.

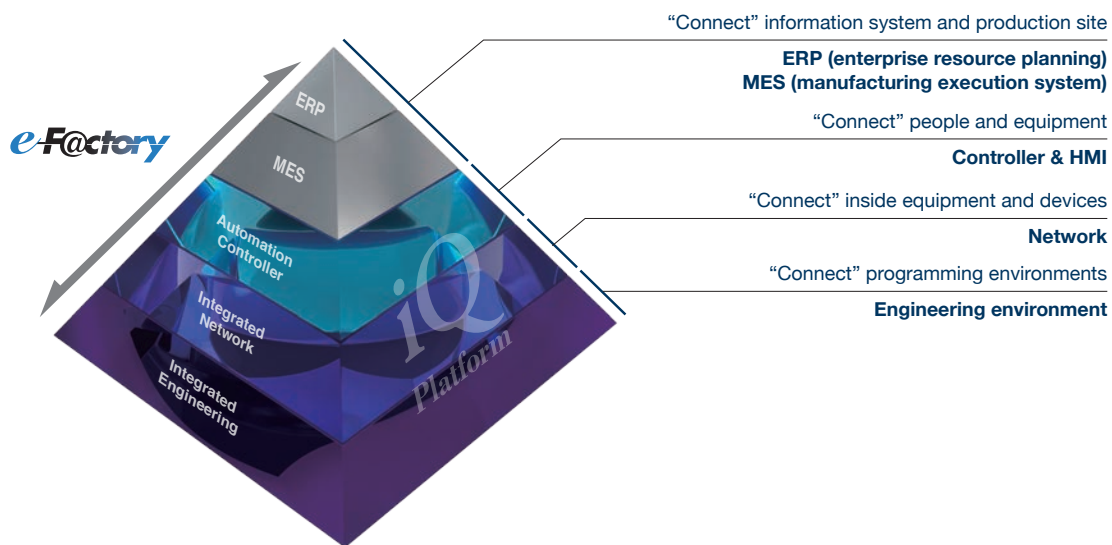

Fundamentally Solving FA’s Task from the Viewpoint of TCO

Controller & HMI

Improving productivity and product quality

1. Significant improvement in total system performance due to high-speed MELSEC series system bus performance
2. Equipped with dedicated memory for FB*1/ label required for program standardization
3. Integrated, enhanced security function

Network

Loss reduction with high precision and production speed

1. Can capture 1-Gbps high-speed communication on various networks, including CC-Link IE TSN, with no loss
2. Realizing seamless communication of various devices using SLMP*2

Engineering environment

Efficient development, operation, and maintenance

1. Possible to detect and generate a large-scale network configuration diagram from the actual machine
2. Realized mutual reflection of parameters between MELSOFT Navigator and each engineering software
3. Automatically following device change of system labels held commonly between each controller and HMI



*1: Function Block

*2: SeamLess Message Protocol

MELSEC iQ-F series

Designed on the concepts of outstanding performance, superior drive control and user centric programming, Mitsubishi Electric MELSEC-F series has been reborn as the MELSEC iQ-F series.

From stand-alone use to networked system applications, MELSEC iQ-F series brings your business to the next level of industry.



Function and cost performance required for small-scale/stand-alone control



Built-in Functions [For details, go to P14.](#)

Even easier to use with the fulfilling built-in functions. Supports the customer to “go one step ahead in manufacturing”.



Safety Control [For details, go to P20.](#)

Safety extension modules that have obtained certification (Category 4, PL e, and SIL3) which complies with international safety standards bring safety to machinery and equipment.



Analog Control [For details, go to P24.](#)

Analog control suitable for the application is possible by using expansion modules in addition to the analog input/output function of the FX5U CPU module.



Positioning Control [For details, go to P28.](#)

Not only built-in positioning but full positioning is also possible by using extension modules.

Design concept of micro PLC

Performance

Outstanding performance

- High-speed system bus
- Extensive built-in functions
- Enhanced security functions
- Battery-less

Affinity

Cooperation with driving equipment

- Easy built-in positioning (4 axes*1 200 kpps)
- Simple interpolation functions*2
- 4/8-axis synchronization control (no special software required) by motion module, simple motion module

Programmer's workbench

Improvement of programming environment

- Easy programming by drag and drop
- Reduced development time with module FB
- Parameterized setup for a variety of functions

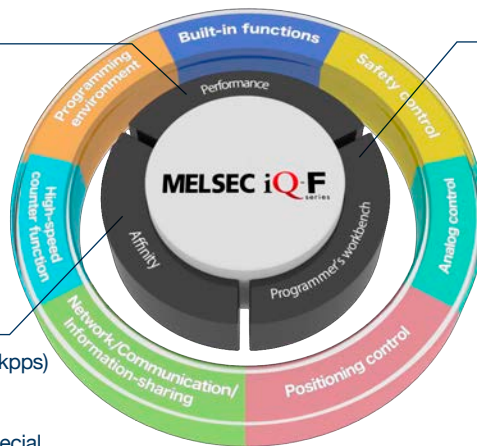

High-Speed Counter Function

For details, go to P34.

The high-performance, high-speed counter built-in the CPU module enables high-speed control with a simple program.



Network/Communication/Information-sharing

For details, go to P36.

Lineup of modules compatible with various open networks, including CC-Link IE TSN and OPC UA.



Programming Environment

For details, go to P50.

Realized graphical intuitive operability, and easy programming by just “selecting”.

*1: Three axes in the FX5UJ CPU module.
*2: Supported only by the FX5U/FX5UC CPU module.

System Configuration

FX5UJ

FX5UJ with excellent cost performance that can be used in any scene

FX5UJ has an SD memory card slot, built-in USB (Mini-B) connector, and built-in Ethernet port as a standard. In addition, built-in functions such as positioning and high-speed counters are included to condense various functions and ease of use.

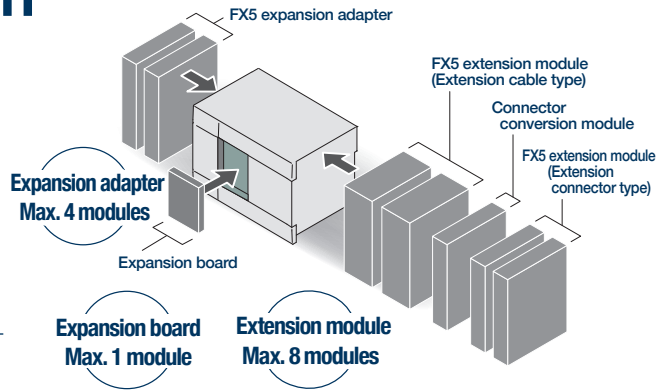

FX5 expansion adapter



Max. 2*1 modules

Communication

FX5-232ADP	For RS-232C communication
FX5-485ADP	For RS-485 communication



Max. 2 modules

Analog

- ★ FX5-4A-ADP For analog input/output
- FX5-4AD-ADP For analog input
- FX5-4DA-ADP For analog output
- FX5-4AD-PT-ADP For resistance temperature detector input
- FX5-4AD-TC-ADP For thermocouple input

FX5 expansion board



Max. 1 module

Communication

FX5-232-BD	For RS-232C communication
FX5-485-BD	For RS-485 communication
FX5-422-BD-GOT	For RS-422 communication (For GOT connection)

Peripheral device

HMI

GOT2000, GOT1000

FX5UJ CPU module



FX5UJ-24MR/ES	AC D2 R
FX5UJ-24MT/ES	AC D2 T1
FX5UJ-24MT/ESS	AC D2 T2



FX5UJ-40MR/ES	AC D2 R
FX5UJ-40MT/ES	AC D2 T1
FX5UJ-40MT/ESS	AC D2 T2









FX5UJ-60MR/ES	AC D2 R
FX5UJ-60MT/ES	AC D2 T1
FX5UJ-60MT/ESS	AC D2 T2

- AC AC power supply
 - D2 DC input (sink/source)
 - T1 Transistor output (sink)
 - T2 Transistor output (source)
 - R Relay output
- Connector connection
 - Cable connection

★: New product

Option

Terminal block	I/O cable	Connector for external device															
 <table border="0" style="width: 100%; font-size: x-small;"> <tr> <td style="width: 50%;">FX-16E-TB</td> <td style="width: 50%;">FX-16E-TB/UL</td> </tr> <tr> <td>FX-32E-TB</td> <td>FX-32E-TB/UL</td> </tr> <tr> <td>FX-16EYR-TB</td> <td>FX-16EYR-ES-TB/UL</td> </tr> <tr> <td>FX-16EYS-TB</td> <td>FX-16EYS-ES-TB/UL</td> </tr> <tr> <td>FX-16EYT-TB</td> <td>FX-16EYT-ESS-TB/UL</td> </tr> </table>	FX-16E-TB	FX-16E-TB/UL	FX-32E-TB	FX-32E-TB/UL	FX-16EYR-TB	FX-16EYR-ES-TB/UL	FX-16EYS-TB	FX-16EYS-ES-TB/UL	FX-16EYT-TB	FX-16EYT-ESS-TB/UL	 <ul style="list-style-type: none"> ● General-purpose input/output cable FX-16E-500CAB-S (5 m, 20-pin single wire) ● For terminal block FX-16E-□CAB (20-pin on both ends) □: 150 (1.5 m) / 300 (3 m) / 500 (5 m) ● For terminal block FX-16E-□CAB-R (20-pin on both ends) □: 150 (1.5 m) / 300 (3 m) / 500 (5 m) 	 <ul style="list-style-type: none"> ● Soldering type (straight out)*3 A6CON1 (40-pin) ● Crimping type (straight out)*3 A6CON2 (40-pin) ● Soldering type (straight/diagonal out)*3 A6CON4 (40-pin) <p style="font-size: x-small;">Connector for self-making I/O cable</p> <ul style="list-style-type: none"> ● For flat cable FX2C-I/O-COON (0.1 mm², 20-pin) ● Connector for single wire FX2C-I/O-COON-S (0.3 mm², 20-pin) FX2C-I/O-COON-SA (0.5 mm², 20-pin) 	<div style="background-color: black; color: white; text-align: center; padding: 2px; margin-bottom: 5px;">Extended extension cable</div>  <ul style="list-style-type: none"> ● Extended extension cable FX5-30EC*2 FX5-65EC*2 	<div style="background-color: black; color: white; text-align: center; padding: 2px; margin-bottom: 5px;">Power supply cable</div>  <ul style="list-style-type: none"> ● Power supply cable FX2NC-100BPCB (1 m) ● Power crossover cable FX2NC-10BPCB1 (0.1 m) 	<div style="background-color: black; color: white; text-align: center; padding: 2px; margin-bottom: 5px;">SD memory card</div>  <ul style="list-style-type: none"> NZ1MEM-2GBSD (2 GB) NZ1MEM-4GBSD (4 GB) NZ1MEM-8GBSD (8 GB) NZ1MEM-16GBSD (16 GB) 	<div style="background-color: black; color: white; text-align: center; padding: 2px; margin-bottom: 5px;">Communication cable</div>  <ul style="list-style-type: none"> ● Serial communication FX-232CAB-1 ● USB communication MR-J3USBCBL3M (3 m) GT09-C30USB-5P (3 m) 	<div style="background-color: black; color: white; text-align: center; padding: 2px; margin-bottom: 5px;">Engineering tool</div> <p style="font-size: x-small;">GX Works3</p>
FX-16E-TB	FX-16E-TB/UL																
FX-32E-TB	FX-32E-TB/UL																
FX-16EYR-TB	FX-16EYR-ES-TB/UL																
FX-16EYS-TB	FX-16EYS-ES-TB/UL																
FX-16EYT-TB	FX-16EYT-ESS-TB/UL																

Outline specifications

Item	Outline specifications	
Power supply	Rated voltage	100 to 240 V AC, 50/60 Hz
	Power consumption*1	30 W (24M), 32 W (40M), 35 W (60M)
	Rush current	24M: max. 25 A for 5 ms or less/100 V AC, max. 50 A for 5 ms or less/200 V AC 40M/60M: max. 30 A for 5 ms or less/100 V AC, max. 50 A for 5 ms or less/200 V AC
	24 V DC service power supply capacity*2	400 mA (24M, 40M, 60M) When an external power supply is used for the input circuit of the CPU module: 460 mA (24M), 500 mA (40M), 550 mA (60M)
Input/output	Input specifications	5.3 mA/24 V DC (X10 and later: 4.0 mA/24 V DC)
	Output specifications	Relay output type: 2 A/1 point, 6 A or less/3 points common, 8 A or less/4 points common, 30 V DC or less, 240 V AC or less (250 V AC or less in case of noncompliance with CE, UL/cUL Standards) Transistor output type: 0.5 A/1 point, 0.6 A or less/3 points common, 0.8 A or less/4 points common, 5-30 V DC
	Input/output extension	Extension devices for FX5 can be connected: when adding an extension connector type, the connector conversion module (FX5-CNV-IF) is required.
Built-in communication port	Ethernet (100BASE-TX/10BASE-T), USB (Mini-B) 1 ch each	
Built-in memory card slot	1 slot for SD memory card	

*1: The values show the state where the service power of 24 V DC is consumed to the maximum level in case that its configuration has the max. number of connections provided to CPU module. (Including the current in the input circuit)

*2: When I/O modules are connected, they consume current from the 24 V DC service power supply. For details on the 24 V DC service power supply, refer to MELSEC iQ-F FX5UJ User's Manual (Hardware).

Please choose the I/O type of CPU module or I/O module suited for your equipment. Refer to the page below for the details of I/O type of each product.

FX5 extension module (Extension cable type)

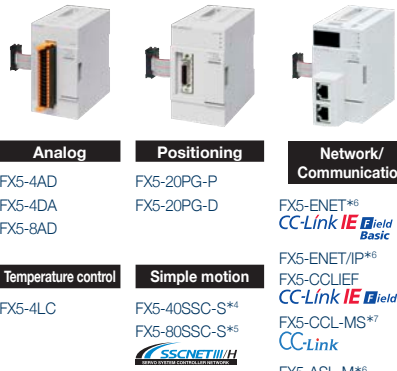
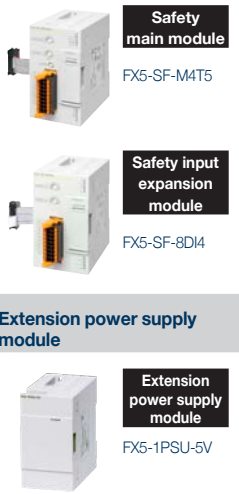
I/O module	Intelligent function module	Safety extension module*8
 <p>Powered I/O module FX5-32ER/ES FX5-32ET/ES FX5-32ET/ESS</p> <p>Input module FX5-8EX/ES FX5-16EX/ES</p> <p>I/O module FX5-16ER/ES FX5-16ET/ES FX5-16ET/ESS</p> <p>Output module FX5-8EYR/ES FX5-8EYT/ES FX5-8EYT/ESS FX5-16EYR/ES FX5-16EYT/ES FX5-16EYT/ESS</p>	 <p>Analog FX5-4AD FX5-4DA FX5-8AD</p> <p>Positioning FX5-20PG-P FX5-20PG-D</p> <p>Network/Communication FX5-ENET*6 CC-Link IE Field Basic FX5-ENET/IP*6 FX5-CCLIEF CC-Link IE Field FX5-CCL-MS*7 CC-Link FX5-ASL-M*8 AnyWireASLINK FX5-DP-M*6</p> <p>Temperature control FX5-4LC</p> <p>Simple motion FX5-40SSC-S*4 FX5-80SSC-S*5</p>	 <p>Safety main module FX5-SF-M4T5</p> <p>Safety input expansion module FX5-SF-8DI4</p> <p>Extension power supply module FX5-1PSU-5V</p>

FX5 extension module (Extension cable type)

Connector conversion module



Connector conversion module
FX5-CNV-IF

FX5 extension module (Extension connector type)

I/O module



I/O module
FX5-C32ET/D*9
FX5-C32ET/DSS
FX5-C32ET/DS-TS*10
FX5-C32ET/DSS-TS*10

Input module



Input module
FX5-C16EX/D*9
FX5-C16EX/DS
FX5-C32EX/D*9
FX5-C32EX/DS
FX5-C32EX/DS-TS*10

Output module



Output module
FX5-C16EYT/D
FX5-C16EYT/DSS
FX5-C16EYR/D-TS*10
FX5-C32EYT/D
FX5-C32EYT/DSS
FX5-C32EYT/D-TS*10
FX5-C32EYT/DSS-TS*10

*1: When connecting the expansion board to the CPU module, only one communication adapter can be connected.
*2: Use this to connect a module (extension cable type) located distantly or on a second stage. The connector conversion adapter (FX5-CNV-BC) is required when the connection destination is I/O module (extension cable type) or intelligent function module.
*3: For FX5-20PG-P and FX5-20PG-D.
*4: Only one module may be connected per system. Use together with the FX5-80SSC-S is not possible.
*5: Only one module may be connected per system. Use together with the FX5-40SSC-S is not possible.

*6: Only one module may be connected per system.
*7: One module can be connected to the system for each station type.
• Master station: 1 • Intelligent device station: 1
*8: When the FX5 safety extension modules are connected, extension modules cannot be connected on the subsequent stage (the right side).
*9: FX2NC-100BPCB is required separately when adding to FX5UJ CPU module.
*10: Spring clamp terminal block type.

System Configuration



Flagship model equipped with advanced built-in functions and diverse expandability

FX5U is equipped with analog functions, communication and high-speed I/O, and can easily be expanded with expansion boards and adapters. The high-speed system bus communication brings out the maximum performance of extension devices equipped with intelligent functions.

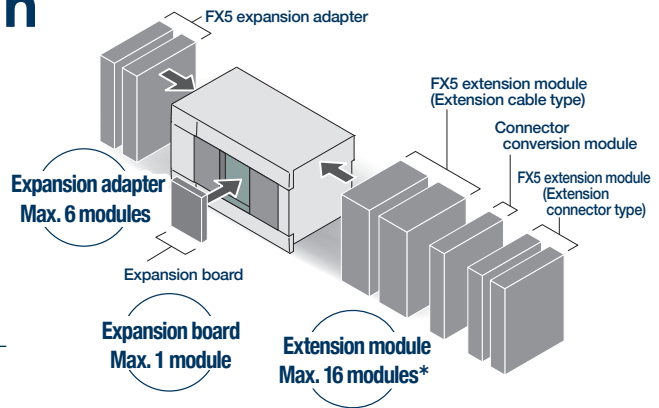

*: Up to 12 modules can be used by directly connecting a CPU module. Up to 16 modules can be connected by connecting a powered I/O module or an extension power supply module. Extension power supply modules and connector conversion modules are not included in the number of connected modules.

FX5 expansion adapter



Max. 2 modules

Communication

FX5-232ADP For RS-232C communication
FX5-485ADP For RS-485 communication



Max. 4 modules

Analog

★ FX5-4A-ADP*1 For analog input/output
FX5-4AD-ADP For analog input
FX5-4DA-ADP For analog output
FX5-4AD-PT-ADP For resistance temperature detector input
FX5-4AD-TC-ADP*2 For thermocouple input

FX5 expansion board



Max. 1 module

Communication

FX5-232-BD For RS-232C communication
FX5-485-BD For RS-485 communication
FX5-422-BD-GOT For RS-422 communication (For GOT connection)

Peripheral device

HMI

GOT2000, GOT1000

FX5U CPU module



FX5U-32MR/ES	AC	D2	R
FX5U-32MT/ES	AC	D2	T1
FX5U-32MT/ESS	AC	D2	T2
FX5U-32MR/DS	DC	D2	R
FX5U-32MT/DS	DC	D2	T1
FX5U-32MT/DSS	DC	D2	T2

Input: 16 points/Output: 16 points



FX5U-64MR/ES	AC	D2	R
FX5U-64MT/ES	AC	D2	T1
FX5U-64MT/ESS	AC	D2	T2
FX5U-64MR/DS	DC	D2	R
FX5U-64MT/DS	DC	D2	T1
FX5U-64MT/DSS	DC	D2	T2





Input: 32 points/Output: 32 points



FX5U-80MR/ES	AC	D2	R
FX5U-80MT/ES	AC	D2	T1
FX5U-80MT/ESS	AC	D2	T2
FX5U-80MR/DS	DC	D2	R
FX5U-80MT/DS	DC	D2	T1
FX5U-80MT/DSS	DC	D2	T2

Input: 40 points/Output: 40 points

Option

<div style="text-align: center; background-color: black; color: white; padding: 2px; margin-bottom: 5px;">Terminal block</div>  <p>FX-16E-TB FX-16E-TB/UL FX-32E-TB FX-32E-TB/UL FX-16EYR-TB FX-16EYR-ES-TB/UL FX-16EYS-TB FX-16EYS-ES-TB/UL FX-16EYT-TB FX-16EYT-ESS-TB/UL</p>	<div style="text-align: center; background-color: black; color: white; padding: 2px; margin-bottom: 5px;">I/O cable</div>  <ul style="list-style-type: none"> ● General-purpose input/output cable FX-16E-500CAB-S (5 m, 20-pin single wire) ● For terminal block FX-16E-□CAB (20-pin on both ends) □: 150 (1.5 m) /300 (3 m) /500 (5 m) ● For terminal block FX-16E-□CAB-R (20-pin on both ends) □: 150 (1.5 m) /300 (3 m) /500 (5 m) 	<div style="text-align: center; background-color: black; color: white; padding: 2px; margin-bottom: 5px;">Extended extension cable</div>  <ul style="list-style-type: none"> ● Extended extension cable FX5-30EC*5 FX5-65EC*5 <div style="text-align: center; margin-bottom: 10px;">  </div> <ul style="list-style-type: none"> ● Connector conversion adapter FX5-CNV-BC
<div style="text-align: center; background-color: black; color: white; padding: 2px; margin-bottom: 5px;">Engineering tool</div> <p>GX Works3</p>	<div style="text-align: center; background-color: black; color: white; padding: 2px; margin-bottom: 5px;">Battery</div> <p>FX3U-32BL</p>	<div style="text-align: center; background-color: black; color: white; padding: 2px; margin-bottom: 5px;">Power supply cable</div> <ul style="list-style-type: none"> ● Power supply cable FX2NC-100BPCB (1 m) ● Power crossover cable FX2NC-10BPCB1 (0.1 m)
Connector for external device		

<ul style="list-style-type: none"> ● Soldering type (straight out)*3 A6CON1 (40-pin) ● Crimping type (straight out)*3 A6CON2 (40-pin) ● Soldering type (straight/diagonal out)*3 A6CON4 (40-pin) 	<ul style="list-style-type: none"> ● Connector for self-making I/O cable ● For flat cable FX2C-I/O-CON (0.1 mm², 20-pin) ● Connector for single wire FX2C-I/O-CON-S (0.3 mm², 20-pin) ● FX2C-I/O-CON-SA (0.5 mm², 20-pin) ● FX-I/O-CON2-S (0.3 mm², 40-pin)*4 ● FX-I/O-CON2-SA (0.5 mm², 40-pin)*4
---	---

 SD memory card NZ1MEM-2GBSD (2 GB) NZ1MEM-4GBSD (4 GB) NZ1MEM-8GBSD (8 GB) NZ1MEM-16GBSD (16 GB) |

AC AC power supply T1 Transistor output (sink)
DC DC power supply T2 Transistor output (source)
D2 DC input (sink/source) R Relay output

Connector connection Cable connection
★ : New product



Outline specifications

Item		Outline specifications
Power supply	Rated voltage	AC power supply type: 100 to 240 V AC, 50/60 Hz DC power supply type: 24 V DC
	Power consumption*1	AC power supply type: 30 W (32M), 40 W (64M), 45 W (80M) DC power supply type: 30 W (32M), 40 W (64M), 45 W (80M)
	Rush current	AC power supply type: 32M: max. 25 A for 5 ms or less/100 V AC, max. 50 A for 5 ms or less/200 V AC 64M/80M: max. 30 A for 5 ms or less/100 V AC, max. 60 A for 5 ms or less/200 V AC DC power supply type: 32M: max. 50 A for 0.5 ms or less/24 V DC 64M/80M: max. 65 A for 2.0 ms or less/24 V DC
	5 V DC internal power supply capacity	AC power supply type: 900 mA (32M), 1100 mA (64M/80M) DC power supply type: 900 mA (775 mA*3) (32M), 1100 mA (975 mA*3) (64M/80M)
	24 V DC service power supply capacity	AC power supply type: 400 mA [300 mA*3] (32M), 600 mA [300 mA*3] (64M/80M) When an external power supply is used for the input circuit of the CPU module: 480 mA [380 mA*3] (32M), 740 mA [440 mA*3] (64M), 770 mA [470 mA*3] (80M)
	24 V DC internal power supply capacity	DC power supply type: 480 mA (360 mA*3) (32M), 740 mA (530 mA*3) (64M), 770 mA (560 mA*3) (80M)
Input/output	Input specifications	5.3 mA/24 V DC (X20 and later: 4.0 mA/24 V DC)
	Output specifications	Relay output type: 2 A/1 point, 8 A or less/4 points common, 8 A or less/8 points common, 30 V DC or less, 240 V AC or less (250 V AC or less in case of noncompliance with CE, UL/cUL Standards) Transistor output type: 0.5 A/1 point, 0.8 A or less/4 points common, 1.6 A or less/8 points common, 5-30 V DC
	Input/output extension	Extension devices for FX5 can be connected: when adding an extension connector type, the connector conversion module (FX5-CNV-IF) is required.
Built-in communication port		Ethernet (100BASE-TX/10BASE-T), RS-485 1 ch each
Built-in memory card slot		1 slot for SD memory card
Built-in analog input/output		Input 2 ch, output 1 ch

- *1: The values show the state where the service power of 24 V DC is consumed to the maximum level in case that its configuration has the max. number of connections provided to CPU module. (Including the current in the input circuit)
- *2: The values in the parentheses () indicate the power supply capacity to be resulted when the power supply voltage falls in the range from 16.8 to 19.2 V DC.
- *3: The values in the brackets [] will result when the ambient temperature is less than 0°C during operations.

Please choose the I/O type of CPU module or I/O module suited for your equipment. Refer to the page below for the details of I/O type of each product.

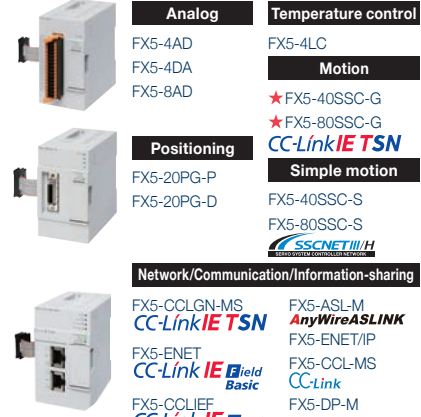
FX5 extension module (Extension cable type)

I/O module	Intelligent function module	Safety extension module*8																				
 <table border="1"> <tr> <th>Powered I/O module</th> <th>Input module</th> <th>I/O module</th> </tr> <tr> <td>FX5-32ER/ES*6 FX5-32ET/ES*6 FX5-32ET/ESS*6 FX5-32ER/DS*7 FX5-32ET/DS*7 FX5-32ET/DSS*7</td> <td>FX5-8EX/ES FX5-16EX/ES FX5-16ET/ESS FX5-8EYR/ES FX5-8EYT/ES FX5-8EYT/ESS FX5-16EYR/ES FX5-16EYT/ES FX5-16EYT/ESS</td> <td>FX5-16ER/ES FX5-16ET/ES FX5-16ET/ESS High-speed pulse input/output module FX5-16ET/ES-H FX5-16ET/ESS-H</td> </tr> </table>	Powered I/O module	Input module	I/O module	FX5-32ER/ES*6 FX5-32ET/ES*6 FX5-32ET/ESS*6 FX5-32ER/DS*7 FX5-32ET/DS*7 FX5-32ET/DSS*7	FX5-8EX/ES FX5-16EX/ES FX5-16ET/ESS FX5-8EYR/ES FX5-8EYT/ES FX5-8EYT/ESS FX5-16EYR/ES FX5-16EYT/ES FX5-16EYT/ESS	FX5-16ER/ES FX5-16ET/ES FX5-16ET/ESS High-speed pulse input/output module FX5-16ET/ES-H FX5-16ET/ESS-H	 <table border="1"> <tr> <th>Analog</th> <th>Temperature control</th> </tr> <tr> <td>FX5-4AD FX5-4DA FX5-8AD</td> <td>FX5-4LC Motion ★ FX5-40SSC-G ★ FX5-80SSC-G CC-Link IETS Simple motion FX5-40SSC-S FX5-80SSC-S SSCNET III/H</td> </tr> <tr> <th>Positioning</th> <th>Network/Communication/Information-sharing</th> </tr> <tr> <td>FX5-20PG-P FX5-20PG-D</td> <td>FX5-CCLGN-MS CC-Link IETS FX5-ENET CC-Link IE Field Basic FX5-CCLIEF CC-Link IE Field</td> </tr> <tr> <td></td> <td>FX5-ASL-M AnyWire ASLINK FX5-ENET/IP FX5-CCL-MS CC-Link FX5-DP-M ★ FX5-OPC OPC UA</td> </tr> </table>	Analog	Temperature control	FX5-4AD FX5-4DA FX5-8AD	FX5-4LC Motion ★ FX5-40SSC-G ★ FX5-80SSC-G CC-Link IETS Simple motion FX5-40SSC-S FX5-80SSC-S SSCNET III/H	Positioning	Network/Communication/Information-sharing	FX5-20PG-P FX5-20PG-D	FX5-CCLGN-MS CC-Link IETS FX5-ENET CC-Link IE Field Basic FX5-CCLIEF CC-Link IE Field		FX5-ASL-M AnyWire ASLINK FX5-ENET/IP FX5-CCL-MS CC-Link FX5-DP-M ★ FX5-OPC OPC UA	 <table border="1"> <tr> <th>Safety main module</th> </tr> <tr> <td>FX5-SF-MU4T5</td> </tr> <tr> <th>Safety input expansion module</th> </tr> <tr> <td>FX5-SF-8DI4</td> </tr> </table>	Safety main module	FX5-SF-MU4T5	Safety input expansion module	FX5-SF-8DI4
Powered I/O module	Input module	I/O module																				
FX5-32ER/ES*6 FX5-32ET/ES*6 FX5-32ET/ESS*6 FX5-32ER/DS*7 FX5-32ET/DS*7 FX5-32ET/DSS*7	FX5-8EX/ES FX5-16EX/ES FX5-16ET/ESS FX5-8EYR/ES FX5-8EYT/ES FX5-8EYT/ESS FX5-16EYR/ES FX5-16EYT/ES FX5-16EYT/ESS	FX5-16ER/ES FX5-16ET/ES FX5-16ET/ESS High-speed pulse input/output module FX5-16ET/ES-H FX5-16ET/ESS-H																				
Analog	Temperature control																					
FX5-4AD FX5-4DA FX5-8AD	FX5-4LC Motion ★ FX5-40SSC-G ★ FX5-80SSC-G CC-Link IETS Simple motion FX5-40SSC-S FX5-80SSC-S SSCNET III/H																					
Positioning	Network/Communication/Information-sharing																					
FX5-20PG-P FX5-20PG-D	FX5-CCLGN-MS CC-Link IETS FX5-ENET CC-Link IE Field Basic FX5-CCLIEF CC-Link IE Field																					
	FX5-ASL-M AnyWire ASLINK FX5-ENET/IP FX5-CCL-MS CC-Link FX5-DP-M ★ FX5-OPC OPC UA																					
Safety main module																						
FX5-SF-MU4T5																						
Safety input expansion module																						
FX5-SF-8DI4																						
		 <table border="1"> <tr> <th>Extension power supply module</th> </tr> <tr> <td>FX5-1PSU-5V*6*9</td> </tr> </table>	Extension power supply module	FX5-1PSU-5V*6*9																		
Extension power supply module																						
FX5-1PSU-5V*6*9																						

FX5 extension module (Extension cable type)

Connector conversion module

FX5-CNV-IF

FX5 extension module (Extension connector type)

Extension power supply module

FX5-C1PS-5V*7*9

I/O module

I/O module	Input module	Output module
FX5-C32ET/D*10 FX5-C32ET/DSS FX5-C32ET/DS-TS*11 FX5-C32ET/DSS-TS*11	FX5-C16EX/D*10 FX5-C16EX/DS FX5-C32EX/D*10 FX5-C32EX/DS FX5-C32EX/DS-TS*11	FX5-C16EYT/D FX5-C16EYT/DSS FX5-C16EYR/D-TS*11 FX5-C32EYT/D FX5-C32EYT/DSS FX5-C32EYT/D-TS*11 FX5-C32EYT/DSS-TS*11

Bus conversion module FX3 extension module*12

Bus conversion module

FX5-CNV-BUSC

Bus conversion module

FX5-CNV-BUS

Intelligent function module

Analog	Temperature control
FX3U-4AD For input FX3U-4DA For output	FX3U-4LC Temperature control
Positioning	High speed counter
FX3U-1PG For pulse output	FX3U-2HC For high-speed input
Communication/Network	
FX3U-64CCL FX3U-16CCL-M FX3U-128ASL-M FX3U-32DP	CC-Link slave CC-Link master AnyWire ASLINK master PROFIBUS-DP slave

Extension power supply module

Extension power supply module

FX3U-1PSU-5V*6*9

- *1: Up to two modules of the FX5-4A-ADP can be connected in the entire system. There are restrictions on the order of connection of the FX5-4A-ADP. For details, refer to the manual.
- *2: There are restrictions on the number of extension devices and the connection order of FX5-4AD-TC-ADP. For details, refer to the manual.
- *3: For FX5-20PG-P and FX5-20PG-D.
- *4: For FX3U-2HC.
- *5: Attach when connecting an extension cable type module to a distant location or when making two-tier connections. The connector conversion adapter (FX5-CNV-BC) is required when connected with an input/output module (extension cable type), high-speed pulse input/output module, or an intelligent function module. When using also the bus conversion module in the same system, connect the FX5 extension power supply module or the powered I/O module right after the extended extension cable.

- *6: Can be connected only to the AC power type system.
- *7: Can be connected only to the DC power type system.
- *8: When the FX5 safety extension modules are connected, extension modules cannot be connected on the subsequent stage (the right side).
- *9: When adding the extension module, it is necessary to connect it to the front stage of extension module in case of a shortage of internal power supply in CPU module.
- *10: FX2NC-100BPCB is required separately when adding to FX5U CPU module.
- *11: Spring clamp terminal block type.
- *12: For the module requiring parameter in FX3 extension module, parameter settings by program are necessary. When connecting the FX3 extension module, the bus speed for FX3 applies for access.

System Configuration

FX5UC

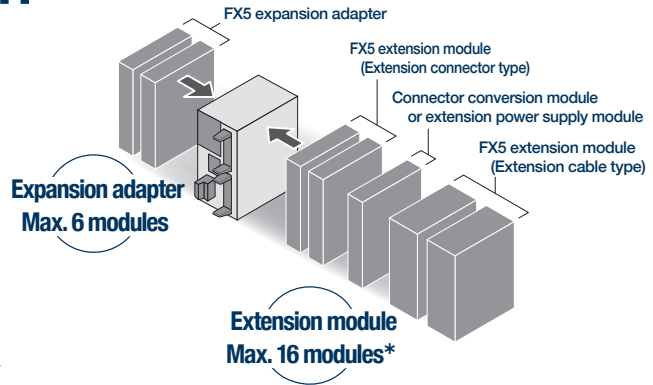

Contributing to miniaturization of equipment by condensing various functions on a compact body

The extension module compatible with FX5UC is compact and easy-to-use, and helps to downsize your system. Easily connect to the FX5 and FX3 extension modules with the variety of conversion modules available.

*: Up to 12 modules can be used by directly connecting a CPU module. Up to 16 modules can be used by connecting a powered I/O module or an extension power supply module. Extension power supply modules and connector conversion modules are not included in the number of connected modules.

FX5 expansion adapter



Max. 2 modules

Communication

FX5-232ADP For RS-232C communication
FX5-485ADP For RS-485 communication



Max. 4 modules

Analog

★ FX5-4A-ADP*1 For analog input/output
FX5-4AD-ADP For analog input
FX5-4DA-ADP For analog output
FX5-4AD-PT-ADP For resistance temperature detector input
FX5-4AD-TC-ADP*2 For thermocouple input

FX5UC CPU module



FX5UC-32MT/D
FX5UC-32MT/DSS
FX5UC-32MT/DS-TS*3
FX5UC-32MT/DSS-TS*3
FX5UC-32MR/DS-TS*3

DC D1 T1
DC D2 T2
DC D2 T1
DC D2 T2
DC D2 R

Input: 16 points/Output: 16 points



FX5UC-64MT/D
FX5UC-64MT/DSS

DC D1 T1
DC D2 T2

Input: 32 points/Output: 32 points



FX5UC-96MT/D
FX5UC-96MT/DSS

DC D1 T1
DC D2 T2

Input: 48 points/Output: 48 points

FX5 extension module (extension connector type)



I/O module

Input module

FX5-C16EX/D*4
FX5-C16EX/DS
FX5-C32EX/D*4
FX5-C32EX/DS
FX5-C32EX/DS-TS*3

Output module

FX5-C16EY/D
FX5-C16EY/DSS
FX5-C16EYR/D-TS*3
FX5-C32EY/D
FX5-C32EY/DSS
FX5-C32EY/D-TS*3
FX5-C32EY/DSS-TS*3

I/O module

FX5-C32ET/D*4
FX5-C32ET/DSS
FX5-C32ET/DS-TS*3
FX5-C32ET/DSS-TS*3

Peripheral device

HMI

GOT2000, GOT1000

- DC DC power supply
- D1 DC input (sink)
- D2 DC input (sink/source)
- T1 Transistor output (sink)
- T2 Transistor output (source)
- R Relay output

 Connector connection
 Cable connection

★: New product

Option

Terminal block	I/O cable	Power supply cable	Extended extension cable	Connector for external device
 <p>FX16E-TB FX32E-TB FX16EYR-TB FX16EYS-TB FX16EYT-TB FX16E-TB/UL FX32E-TB/UL FX16EYR-ES-TB/UL FX16EYS-ES-TB/UL FX16EYT-ESS-TB/UL</p>	 <ul style="list-style-type: none"> ● General-purpose input/output cable FX16E-500CAB-S (5 m, 20-pin single wire) ● For terminal block FX16E-□CAB (20-pin on both ends) □: 150 (1.5 m) / 300 (3 m) / 500 (5 m) ● For terminal block FX16E-□CAB-R (20-pin on both ends) □: 150 (1.5 m) / 300 (3 m) / 500 (5 m) 	<ul style="list-style-type: none"> ● Power cable for CPU modules FX2NC-100MPCB (1 m) (Attached to CPU module and intelligent function module*9) ● Power supply cable FX2NC-100BPCB (1 m) (Attached to FX5UC-□MT/D) ● Power crossover cable FX2NC-10BPCB1 (0.1 m) (Attached to FX5-C□EX/D and FX5-C32ET/D) 	 <ul style="list-style-type: none"> ● Extended extension cable FX5-30EC*6 FX5-65EC*6  <ul style="list-style-type: none"> ● Connector conversion adapter FX5-CNV-BC 	<ul style="list-style-type: none"> ● Soldering type (straight out)*7 A6CON1 (40-pin) ● Crimping type (straight out)*7 A6CON2 (40-pin) ● Soldering type (straight/diagonal out)*7 A6CON4 (40-pin) <p>Connectors for self-making I/O cables</p> <ul style="list-style-type: none"> ● For flat cables FX2C-I/O-CON (0.1 mm², 20-pin) ● Connector for single wire FX2C-I/O-CON-S (0.3 mm², 20-pin) FX2C-I/O-CON-SA (0.5 mm², 20-pin) FX-I/O-CON2-S (0.3 mm², 40-pin)*8 FX-I/O-CON2-SA (0.5 mm², 40-pin)*8
	<div style="background-color: black; color: white; text-align: center; padding: 2px; margin-bottom: 5px;">Engineering tool</div> <p>GX Works3</p>	<div style="background-color: black; color: white; text-align: center; padding: 2px; margin-bottom: 5px;">Battery</div> <p>FX3U-32BL</p>	<div style="background-color: black; color: white; text-align: center; padding: 2px; margin-bottom: 5px;">SD memory card</div> <p>NZ1MEM-2GBSD (2 GB) NZ1MEM-8GBSD (8 GB) NZ1MEM-4GBSD (4 GB) NZ1MEM-16GBSD (16 GB)</p>	

10

Outline specifications

Item		Outline specifications
Power supply	Rated supply voltage	24 V DC
	Power consumption*1	32M: 5 W/24 V DC (30 W/24 V DC +20%, -15%) 64M: 8 W/24 V DC (33 W/24 V DC +20%, -15%) 96M: 11 W/24 V DC (36 W/24 V DC +20%, -15%)
	Rush current	32M: max. 35 A 0.5 ms or less/24 V DC 64M/96M: max. 40 A 0.5 ms or less/24 V DC
	5 V DC power supply capacity	720 mA
	24 V DC power supply capacity	500 mA
Input/output	Input specifications	5.3 mA/24 V DC (X20 and later: 4.0 mA/24 V DC)
	Output specifications	Relay output type: 2 A/1 point or less, 4 A or less/8 points common*2 30 V DC or less, 240 V AC or less (250 V AC or less in case of noncompliance with CE, UL/cUL Standards) Transistor output type: Y0 to Y3 0.3 A/1 point, Y4 and later 0.1 A/1 point, 0.8 A/8 points common*3 5-30 V DC
	Input/output extension	Extension device for FX5 can be connected (extension power supply module (FX5-C1PS-5V) or connector conversion module (FX5-CNV-IFC) is required when connecting an extension cable type)
Built-in communication port		Ethernet (100BASE-TX/10BASE-T), RS-485 1 ch each
Built-in memory card slot		1 slot for SD memory card

*1: The value results when the CPU module is used alone. The values in the parentheses () result when the maximum no. of connections have been made to the CPU module. (External DC 24 V power supplies of extension modules are not included.)

*2: 8 A or less when two common terminals are connected to the external part.

*3: 1.6 A or less when two common terminals are connected to the external part.

FX5 extension module (Extension connector type)

Extension power supply module



Extension power supply module
FX5-C1PS-5V*9*10

or

Connector conversion module



Connector conversion module
FX5-CNV-IFC

Bus conversion module



Bus conversion module
FX5-CNV-BUS



Bus conversion module
FX5-CNV-BUSC

FX5 extension module (Extension cable type)

I/O module



Powered I/O module	Input module	I/O module
FX5-32ER/DS FX5-32ET/DS FX5-32ET/DSS	FX5-8EX/ES FX5-16EX/ES FX5-8EYR/ES FX5-8EYT/ES FX5-8EYT/ESS FX5-16EYR/ES FX5-16EYT/ES FX5-16EYT/ESS	FX5-16ER/ES FX5-16ET/ES FX5-16ET/ESS High-speed pulse input/output module FX5-16ET/ES-H FX5-16ET/ESS-H

Safety extension module*11



Safety main module
FX5-SF-MU4T5

Safety input expansion module
FX5-SF-8D14

FX3 extension module*12

Intelligent function module

Analog	Temperature control	Communication/Network
FX3U-4AD For input FX3U-4DA For output	FX3U-4LC Temperature control	FX3U-64CCL CC-Link slave FX3U-16CCL-M CC-Link master FX3U-128ASL-M AnyWireASLINK master FX3U-32DP PROFIBUS-DP slave
Positioning	High-speed counter	
FX3U-1PG For pulse output	FX3U-2HC For high-speed input	

Please choose the I/O type of CPU module or I/O module suited for your equipment. Refer to the page below for the details of I/O type of each product.

Intelligent function module



Analog	Positioning	Network/Communication/Information-sharing
FX5-4AD FX5-4DA FX5-8AD	FX5-20PG-P FX5-20PG-D	FX5-CCLGN-MS CC-Link IETSN
Temperature control	Motion	FX5-ENET CC-Link IE I^{field} Basic FX5-ENET/IP FX5-CCLIEF CC-Link IE I^{field} Basic
FX5-4LC	★ FX5-40SSC-G ★ FX5-80SSC-G CC-Link IETSN	FX5-CCL-MS CC-Link FX5-ASL-M AnyWireASLINK FX5-DP-M ★ FX5-OPC OPC UA
	Simple motion	
	FX5-40SSC-S FX5-80SSC-S S5CCNET III/H	

*1: Up to two modules of the FX5-4A-ADP can be connected in the entire system. There are restrictions on the order of connection of the FX5-4A-ADP. For details, refer to the manual.

*2: There are restrictions on the number of extension devices and the connection order of FX5-4AD-TC-ADP. For details, refer to the manual.

*3: Spring clamp terminal block type.

*4: FX2NC-100BPCB is required separately when adding to FX5UC-□□□/DS□-TS.

*5: There are some exception models. For details, refer to the manual.

*6: Attach when connecting an extension cable type module to a distant location or when making two-tier connections. The connector conversion adapter (FX5-CNV-BC) is required when connected with an input/output module (extension cable type) or an intelligent function module. When using also the bus conversion module in the same system, connect the powered I/O module right after the extended extension cable.

*7: For FX5-20PG-P and FX5-20PG-D.

*8: For FX3U-2HC.

*9: When adding the extension module, it is necessary to connect it to the front stage of extension module in case of a shortage of internal power supply in CPU module.

*10: Next-stage extension connector of an extension power supply module can be used only for either connector connection or cable connection.

In case of connector connection, an extension connector type module can be connected.

*11: When the FX5 safety extension modules are connected, extension modules cannot be connected on the subsequent stage (the right side).

*12: For the module requiring parameter in FX3 extension module, parameter settings by program are necessary. When connecting the FX3 extension module, the bus speed for FX3 applies for access.

Performance Specifications



FX5UJ

■ FX5UJ CPU module performance specifications

Item		Specifications
Control system		Stored-program repetitive operation
Input/output control system		Refresh system (Direct access input/output allowed by specification of direct access input/output [DX, DY])
Programming specifications	Programming language	Ladder diagram (LD), structured text (ST), function block diagram/ladder diagram (FBD/LD)
	Programming expansion function	Function block (FB), function (FUN), label programming (local/global)
	Constant scan	0.5 to 2000 ms (can be set in 0.1 ms increments)
	Fixed cycle interrupt	1 to 60000 ms (can be set in 1 ms increments)
	Timer performance specifications	100 ms, 10 ms, 1 ms
	No. of program executions	32
Operation specifications	No. of FB files	16 (Up to 15 for user)
	Execution type	Standby type, initial execution type, scan execution type, fixed-cycle execution type, event execution type
Command processing time	Interrupt type	Internal timer interrupt, input interruption, high-speed comparison match interrupt, interrupt by modules*1
	LD X0	34 ns
Memory capacity	MOV D0 D1	34 ns
	Program capacity	48 k steps (96 kbytes, flash memory)
Flash memory (Flash ROM) write count	SD memory card	Memory card capacity (SD/SDHC memory card: Max. 16 Gbytes)
	Device/label memory	120 kbytes
	Data memory/standard ROM	5 Mbytes
		Maximum 20000 times
File storage capacity	Device/label memory	1
	Data memory P: No. of program files FB: No. of FB files	P: 32, FB: 16
	SD memory card	NZ1MEM-2GBSD: 511*2 NZ1MEM-4GBSD, NZ1MEM-8GBSD, NZ1MEM-16GBSD: 65534*2
Clock function	Display data	Year, month, day, hour, minute, second, day of week (leap year automatic detection)
	Precision	Differences per month ±45 sec./25°C (TYP)
No. of input/output points	(1) No. of input/output points	256 points or less
	(2) No. of remote I/O points	256 points or less
	Total No. of points of (1) and (2)	256 points or less
Power failure retention (clock data*3)	Retention method	Large-capacity capacitor
	Retention time	15 days (Ambient temperature: 25°C)
Power failure retention (device)	Power failure retention capacity	Maximum 12 k word

*1: Interrupt from the intelligent function module.

*2: The value listed above indicates the number of files stored in the root folder.

*3: Clock data is retained using the power accumulated in a large-capacity capacitor incorporated into the PLC. When voltage of the large-capacity capacitor drops, clock data is no longer accurately retained. The retention period of a fully charged capacitor (electricity is conducted across the PLC for at least 30 minutes) is 15 days (ambient temperature: 25°C). How long the capacitor can hold the data depends on the operating ambient temperature. When the operating ambient temperature is high, the holding period is short.

■ Number of device points

Item	Base	Max. number of points*		
No. of user device points	Input relay (X)	8	1024 points	
	Output relay (Y)	8	1024 points	
	Internal relay (M)	10	7680 points	
	Latch relay (L)	10	7680 points	
	Link relay (B)	16	2048 points	
	Annunciator (F)	10	128 points	
	Link special relay (SB)	16	2048 points	
	Step relay (S)	10	4096 points	
	Timer system	Timer (T)	10	512 points
		Accumulation timer system	Accumulation timer (ST)	10
	Counter system	Counter (C)	10	256 points
		Long counter (LC)	10	64 points
		Data register (D)	10	8000 points
		Link register (W)	16	1024 points
		Link special register (SW)	16	1024 points
No. of system device points	Special relay (SM)	10	10000 points	
	Special register (SD)	10	12000 points	
Module access device	Intelligent function module device	10	Depends on the intelligent function module.	
No. of index register points	Index register (Z)	10	20 points	
	Long index register (LZ)	10	2 points	
No. of file register points	File register (R)	10	32768 points	
	Extended file register (ER)	10	32768 points (are stored in SD memory card)	
No. of nesting points	Nesting (N)	10	15 points	
No. of pointer points	Pointer (P)	10	2048 points	
	Interrupt pointer (I)	10	178 points	
Others	Decimal constant (K)	Signed	— 16 bits: -32768 to +32767, 32 bits: -2147483648 to +2147483647	
		Unsigned	— 16 bits: 0 to 65535, 32 bits: 0 to 4294967295	
	Hexadecimal constant (H)	— 16 bits: 0 to FFFF, 32 bits: 0 to FFFFFFFF		
	Real constant (E)	Single precision	— E-3.40282347+38 to E-1.17549435-38, 0, E1.17549435-38 to E3.40282347+38	
	Character string	— Shift-JIS code max. 255 single-byte characters (256 including NULL)		

*: Maximum number of points cannot be changed. (fixed)



FX5U **FX5UC**

FX5U/FX5UC CPU module performance specifications

Item		Specifications
Control system		Stored-program repetitive operation
Input/output control system		Refresh system (Direct access input/output allowed by specification of direct access input/output [DX, DY])
Programming specifications	Programming language	Ladder diagram (LD), structured text (ST), function block diagram/ladder diagram (FBD/LD), sequential function chart (SFC)*1
	Programming expansion function	Function block (FB), function (FUN), label programming (local/global)
	Constant scan	0.2 to 2000 ms (can be set in 0.1 ms increments)
	Fixed cycle interrupt	1 to 60000 ms (can be set in 1 ms increments)
	Timer performance specifications	100 ms, 10 ms, 1 ms
	No. of program executions	32
Operation specifications	No. of FB files	16 (Up to 15 for user)
	Execution type	Standby type, initial execution type, scan execution type, fixed-cycle execution type, event execution type
	Interrupt type	Internal timer interrupt, input interruption, high-speed comparison match interrupt, interrupt by module*2
Command processing time	LD X0	34 ns*3
	MOV D0 D1	34 ns*3
Memory capacity	Program capacity	64 k/128 k steps*4 (128 kbytes/256 kbytes, flash memory)
	SD memory card	Memory card capacity (SD/SDHC memory card: Max. 16 Gbytes)
	Device/label memory	150 kbytes*5
	Data memory/standard ROM	5 Mbytes
Flash memory (Flash ROM) write count		Maximum 20000 times
File storage capacity	Device/label memory	1
	Data memory P: No. of program files FB: No. of FB files	P: 32, FB: 16
	SD memory card	NZ1MEM-2GBSD: 511*6 NZ1MEM-4GBSD, NZ1MEM-8GBSD, NZ1MEM-16GBSD: 65534*6
Clock function	Display data	Year, month, day, hour, minute, second, day of week (leap year automatic detection)
	Precision	Differences per month ±45 sec./25°C (TYP)
No. of input/output points	(1) No. of input/output points	256 points or less/384 points or less*4
	(2) No. of remote I/O points	384 points or less/512 points or less*4
	Total No. of points of (1) and (2)	512 points or less
Power failure retention (clock data*7)	Retention method	Large-capacity capacitor
	Retention time	10 days (Ambient temperature: 25°C)
Power failure retention (device)	Power failure retention capacity	Maximum 12 k word*8

*1: Supported in the FX5U/FX5UC CPU module firmware version 1.220 or later. In addition, GX Works3 version 1.070Y or later is required.

*2: Interrupt from the intelligent function module and high-speed pulse input/output module.

*3: When the program capacity is 64 k steps.

*4: Supported in the FX5U/FX5UC CPU module firmware version 1.100 or later. In addition, GX Works3 version 1.047Z or later is required.

*5: Supported in the FX5U/FX5UC CPU module firmware version 1.210 or later. In addition, GX Works3 version 1.065T or later is required.

*6: The value listed above indicates the number of files stored in the root folder.

*7: Clock data is retained using the power accumulated in a large-capacity capacitor incorporated into the PLC. When voltage of the large-capacity capacitor drops, clock data is no longer accurately retained. The retention period of a fully charged capacitor (electricity is conducted across the PLC for at least 30 minutes) is 10 days (ambient temperature: 25°C). How long the capacitor can hold the data depends on the operating ambient temperature. When the operating ambient temperature is high, the holding period is short.

*8: All devices in the device (high-speed) area can be held against power failure. Devices in the device (standard) area can be held also when the optional battery is mounted.

Number of device points

Item	Base	Max. number of points		
		Base	Notes	
No. of user device points	Input relay (X)	8	The total number of X and Y assigned to input/output points is up to 256 points/384 points*1.	
	Output relay (Y)	8		
	Internal relay (M)	10		
	Latch relay (L)	10		
	Link relay (B)	16		
	Annunciator (F)	10		
	Link special relay (SB)	16		
	Step relay (S)	10		
	Timer system	Timer (T)		10
	Accumulation timer system	Accumulation timer (ST)		10
		Counter (C)		10
	Counter system	Counter (C)		10
		Long counter (LC)		10
	Data register (D)	10		
	Link register (W)	16		
	Link special register (SW)	16		
No. of system device points	Special relay (SM)	10		
	Special register (SD)	10		
Module access device	Intelligent function module device	10		
No. of index register points	Index register (Z)*3	10		
	Long index register (LZ)*3	10		
No. of file register points	File register (F)	10		
	Extended file register (ER)	10		
No. of nesting points	Nesting (N)	10		
No. of pointer points	Pointer (P)	10		
	Interrupt pointer (I)	10		
No. of SFC points	SFC block device (BL)	10		
	SFC transition device (TR)	10		
Others	Decimal constant (K)	Signed	16 bits: -32768 to +32767, 32 bits: -2147483648 to +2147483647	
		Unsigned	16 bits: 0 to 65535, 32 bits: 0 to 4294967295	
	Hexadecimal constant (H)	16 bits: 0 to FFFF, 32 bits: 0 to FFFFFFFF		
	Real constant (E)	Single precision	E-3.40282347+38 to E-1.17549435-38, 0, E1.17549435-38 to E3.40282347+38	
Character string			Shift-JIS code max. 255 single-byte characters (256 including NULL) Unicode max. 255 characters (256 including NULL)*4	

*1: Supported in the FX5U/FX5UC CPU module firmware version 1.100 or later. In addition, GX Works3 version 1.047Z or later is required.

*2: Can be changed with parameters within the capacity range of the CPU built-in memory.

*3: The sum of index register (Z) and long index register (LZ) is 24 words.

*4: Supported in the FX5U/FX5UC CPU module firmware version 1.240 or later. In addition, GX Works3 version 1.075D or later is required.



Built-in Functions

The CPU module has excellent built-in functions to respond to various types of control. In addition, an Ethernet port, SD memory card slot, USB (Mini-B) connector (only in the FX5UJ), and RS-485 port (only in the FX5U/FX5UC) are mounted as standard equipment.

The Ethernet port is compatible with CC-Link IE Field Network Basic and can be connected to a wide variety of equipment.

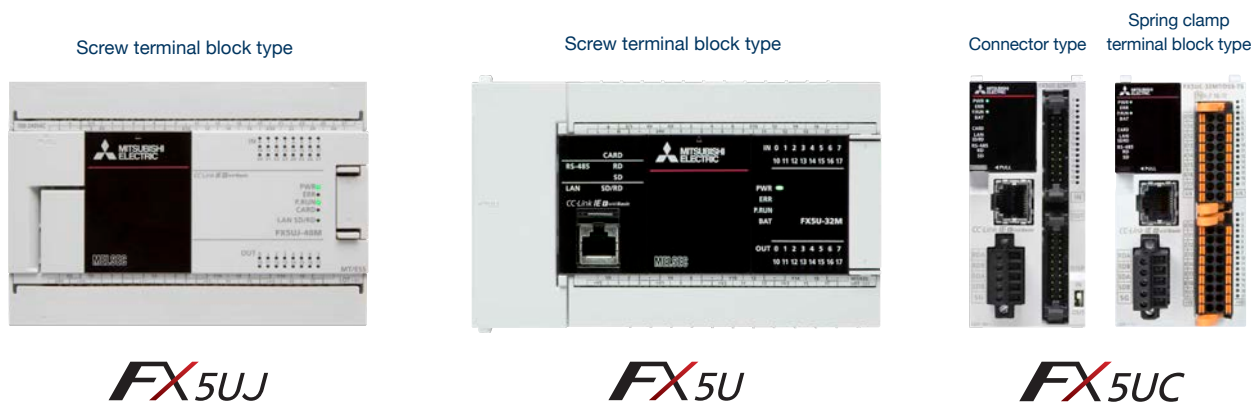

CPU Performance

The MELSEC iQ-F series has a CPU capable of high-speed processing with an instruction operation speed (LD instruction) of 34 ns. In addition, the CPU supports execution of structured programs and multiple programs, ST language, FB etc.

FX5UJ	Program capacity 48 k Steps	Instruction execution speed (LD, MOV instruction) 34 ns	Fixed cycle interrupt program Min. 1 ms
FX5U FX5UC	Program capacity 64 k/128 k*1 Steps	Instruction execution speed (LD, MOV instruction) 34 ns	Fixed cycle interrupt program Min. 1 ms

Built-in Analog Input/Output (with alarm output)

The FX5U has built-in 12-bit 2 ch analog voltage input and 1 ch analog voltage output.



Built-in USB (Mini-B) connector

Another interface for programming is provided in addition to the Ethernet port. The USB (Mini-B) connector mounted as standard makes it easier to connect to GX Works3*3.



*1: Supported by FX5U/FX5UC CPU module Ver. 1.100 or later, and product number 17X**** (product number 178**** for FX5UC-32MT/DS-TS and FX5UC-32MT/DSS-TS) or later. Some operation restrictions apply when 128 k steps is selected. For details, refer to the manual.
*2: Two axes when the pulse output mode is CW/CCW mode.

Built-in Positioning Function

- FX5UJ** • Allows 200 kpps, 3-axis pulse output (Transistor output)
- FX5U** • Compatible with 20 μs high-speed starting and allows 200 kpps, 4-axis pulse output (Transistor output)
- FX5UC**

◇ Number of controllable axes

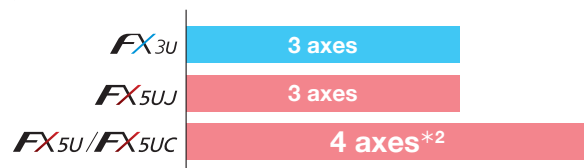

◇ Maximum frequency

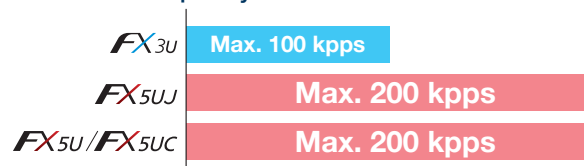

Battery-less and Maintenance-free

In the MELSEC iQ-F series, programs and devices are held in a battery-less*4 memory such as flash ROM.

*3: The driver is installed automatically when the personal computer and CPU module are connected. If the driver is not installed automatically, install it manually. For details, refer to the MELSEC iQ-F FX5 User's Manual (Application).
*4: In the FX5U/FX5UC, the capacity for holding devices can be expanded when the optional battery is used.

Built-in Ethernet Port **CC-Link IE Field Basic**

The Ethernet port can handle communication of up to 8 connections on the network, and also support CC-Link IE Field Network Basic.

Ethernet communication function		Number of connectable stations/modules	
		FX5UJ	FX5U/FX5UC
MELSOFT connection*1		Up to 8 stations in total	Up to 8 stations in total
SLMP	3E frame		
	1E frame*2		
Predefined protocol support			
Socket communication			
MODBUS/TCP communication (Master station/slave station)*2			
CC-Link IE Field Network Basic*2		8 stations	16 stations
Simple CPU communication function*2		8 modules	16 modules
File transfer function*2	FTP server	1 module	1 module
	FTP client	—	1 module
Time setting function (SNTP client)*2		1 module	1 module
Web server*2	System Web page	4 modules	Up to 4 modules in total
	User Web page	—	
Real-time monitoring function*2		1 module	1 module

Built-in RS-485 port (with MODBUS RTU communication)

FX5U FX5UC

Connect to serial devices up to 50 m away with built-in RS-485 port. Control for up to 16 Mitsubishi electric inverters is possible with 6 dedicated inverter communication instructions.

MODBUS RTU communication is also supported and can connect up to 32 MODBUS compatible devices such as PLCs, sensors and temperature controllers.



Built-in SD Memory Card Slot

The built-in SD memory card slot is convenient for updating programs and mass producing products. SD memory cards can store data logging files, Web page data, etc.

>> Data logging function*2

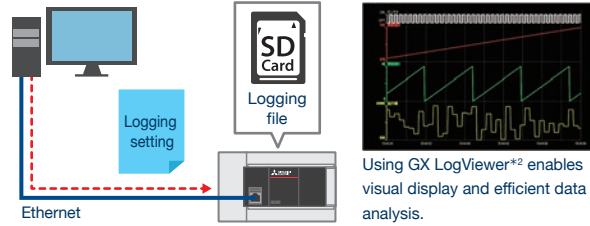

Spring clamp terminal block **FX5UC**

What is a spring clamp terminal block?

Spring clamp terminal blocks hold wires in place by the force of internal springs. Constant force holds wires in place, preventing wires from falling out due to vibration.



What are the advantages?

There is no need for crimp terminals or crimp tools! Wiring is possible without extra time or cost! No external terminal block is needed! Easily detachable & securely fixed by a lock lever!

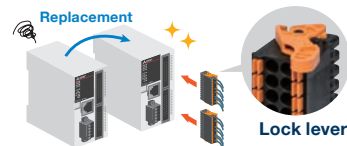

With detachable terminal blocks, the change of wiring is not needed even when replacing the modules!

With spring clamp terminals block type, wiring is complete in 3 steps!

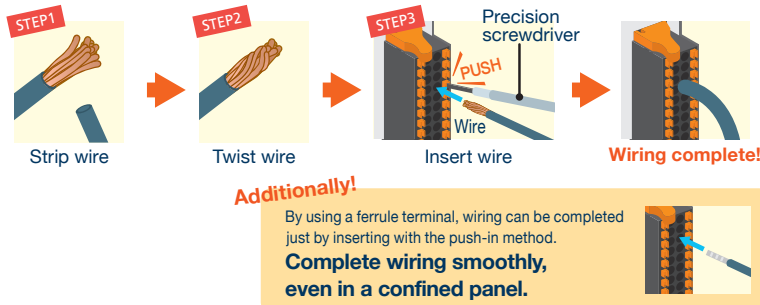

For ferrule terminals, the following is introduced. (Reference product: PHOENIX CONTACT GmbH & Co. KG*)

Model	Type	
CRIMPFOX 6	Crimp tool	
Al 0.5-10 WH	Crimp terminal	Wire size 0.5 mm ²
Al 0.75-10 GY	Ferrule with insulation sleeve)	Wire size 0.75 mm ²
A 1.0-10	Crimp terminal	Wire size 1.0 mm ²
A 1.5-10	Ferrule without insulation sleeve)	Wire size 1.5 mm ²

*: If the product other than the reference product is used, the wire ferrule cannot be pulled out. Sufficiently confirm that the wire ferrule can be pulled out before use.

*1: One MELSOFT connection is not included in the number of connections. (The second and subsequent modules are included.)
*2: For the firmware version and software version of the corresponding CPU module, refer to page 62.

Function Introduction



Built-in Functions



Logging Section
 YouTube
 MITSUBISHI ELECTRIC
 Factory Automation
 MELSEC iQ-F Technical Video

Memory area for each application

The program memory capacity is 64 k/128 k steps*2 in the FX5U/FX5UC CPU module, and 48 k steps in the FX5UJ CPU module. Since these memory areas are reserved for each application, all of this capacity can be used as program area. Therefore, comments and statements can be written without being aware of conflicts within the area.

Maximum number of characters

Comment: 1024 characters Statement: 5000 characters

MELSEC iQ-F series stores the program and devices in non-volatile memory such as Flash ROM, so no battery is required.

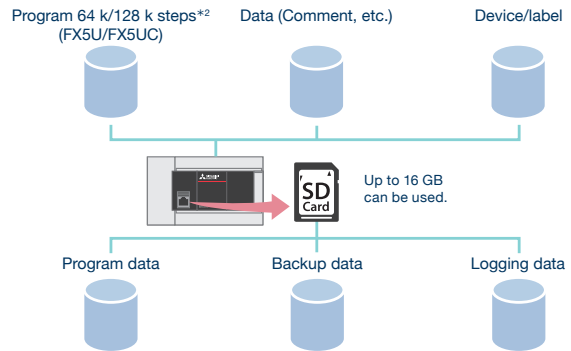

Data logging function*1*3 (Binary file format/CSV file format*1*4)

Up to 512 points of data can be collected at specified intervals or at any timing, and the collected data are saved as CSV files or binary files via SD memory cards. Using the saved data enables efficient analysis of device operating status and the cause of trouble. If simple settings are made with the logging setting tool, no additional program is required.

A trouble can be analyzed efficiently by [trigger logging] which logs only the situation before and after the occurrence of trouble. Important data can be selectively saved by setting conditions. Workpiece measured values can be saved, and used for traceability.

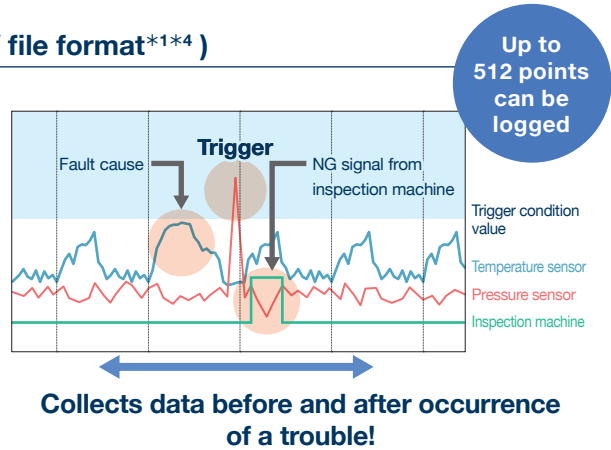

Efficiently analyzing logging data with GX LogViewer*1

GX LogViewer*1 is a tool to display and analyze large volumes of data collected by modules with the data logging function*1, with easy-to-understand operations. It enables the setting of the connection destination by the same operation as the setting tool and engineering tool, and thereby enables easy checking of the logging file.

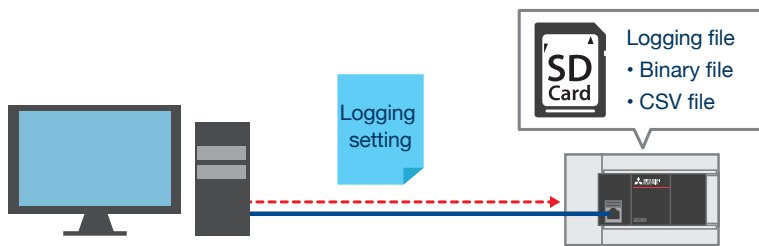

Using GX LogViewer*1 enables visual display and efficient data analysis.

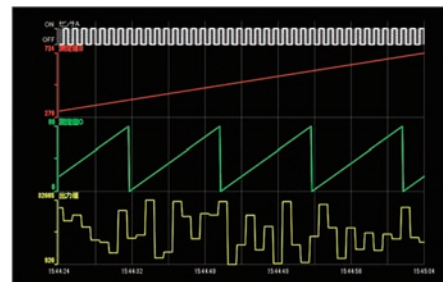

*1: For the firmware version and software version of the corresponding CPU module, refer to page 62.
 *2: Supported by the FX5U/FX5UC CPU module Ver. 1.100 or later and product number 17X**** (product number 178**** for the FX5UC-32MT/DS-TS and FX5UC-32MT/DSS-TS) or later, and GX Works3 Ver. 1.047Z or later. There are some restrictions on the operations given when "128 k steps" is selected. For details, refer to the manual.
 *3: The data logging function and memory dump function cannot be used simultaneously. There are some restrictions on the use of the backup/restore function. For details, refer to the manual.
 *4: Supported only by the FX5U/FX5UC CPU module.

The CSV file format*1*2 is added as the data logging file save format

Data logging files can be saved not only in the binary file format but also in the CSV file format*1*2

Logging files saved in the CSV file format can be opened (viewed) in Microsoft® Excel® and other software.



Specified files can be operated by the program. **NEW**

By using the file operation instruction*2*3, the device data can be read/written to the specified files in an SD memory card.

File transfer function (FTP server*1/FTP client*1*2)

By using the FTP server function*1, workers in the factory can acquire logging files from the office in a remote place. Workers in the office can manage logging files without visiting the factory, and reduce the maintenance work.

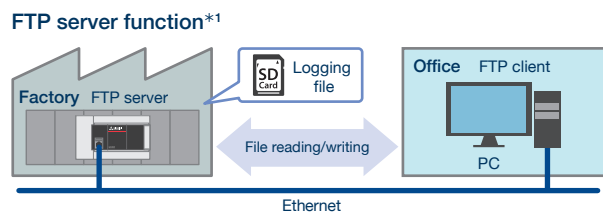

By using the file transfer function command of the FTP client function*1*2, workers in the factory can transfer logging files stored in the PLC in a factory to the host system (FTP server) in the office without complicated settings and operations in the FTP server.

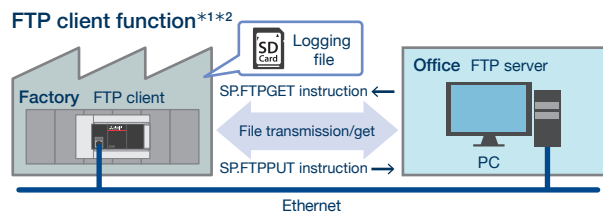

Security

It prevents data theft, tampering, misoperation, illegal execution, etc. caused by unauthorized access from a third party with the security functions (block password, file password, remote password, security key authentication).

>> Example of security key authentication function

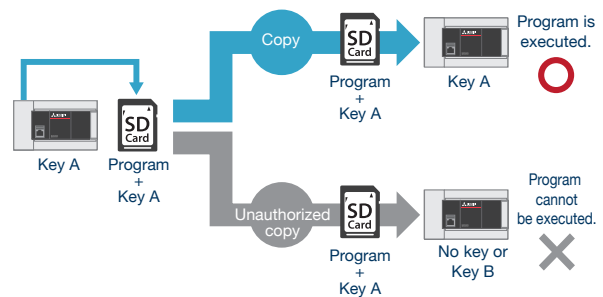

IP filter function*1

When the IP address to be permitted or blocked is set in the MELSEC iQ-F Series built-in function parameters, access from specific devices are restricted. The access source IP address can be identified to prevent accessing from illegal IP addresses.

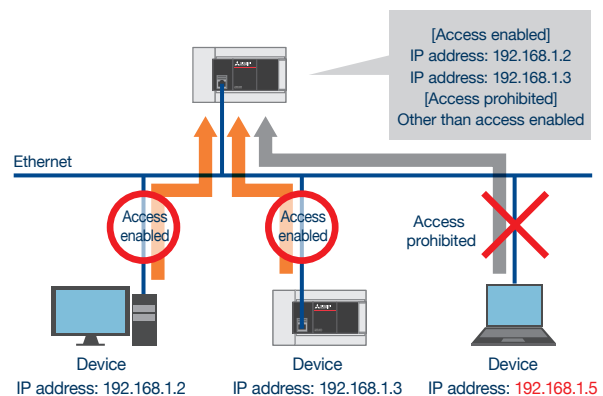

*1: For the firmware version and software version of the corresponding CPU module, refer to page 62.
 *2: Supported only by the FX5U/FX5UC CPU module.
 *3: Supported only by the FX5U/FX5UC CPU module Ver. 1.240 or later.

Function Introduction



Built-in Functions

Backup/restore functions*1 (device/label data*2*3, data memory*2)

The device/label data and data memory in the CPU module can be backed up*4 to the SD memory card. Backed-up data can be restored as needed.

Back up data in case of an emergency!

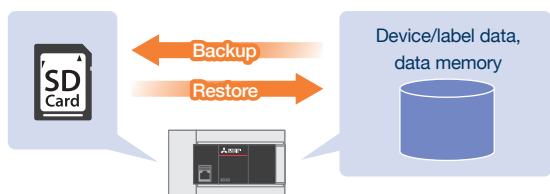

When the SD memory card is mounted in the CPU module, the data can be backed up at any time. The backed up data can be restored at any time.

Restoration is possible even without a PC!

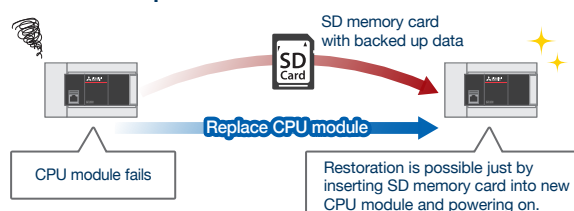

When the CPU module auto exchange function is used, the SD memory card data is automatically restored when the power is turned on or when the CPU module is reset. If the CPU module fails, it can recover promptly without a PC.

Memory dump function*2*5

The CPU module device value can be saved in the SD memory card at any timing.

By setting the trigger to be established when an error occurs, all devices at error occurrence can be saved. This is helpful in investigating and pinpointing the cause.

By setting memory dump...

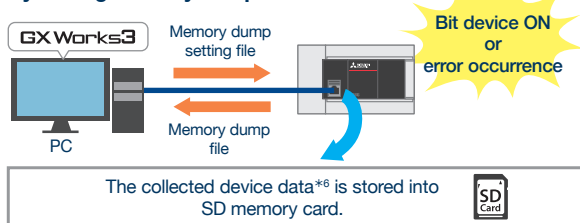

Use the information when debugging systems under development, or for troubleshooting when trouble occurs at a remote location, etc.

Memory dump results display screen

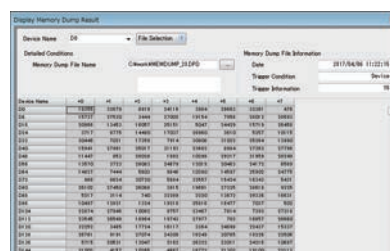

The collection result can be checked in GX Works3.

Offline monitor screen

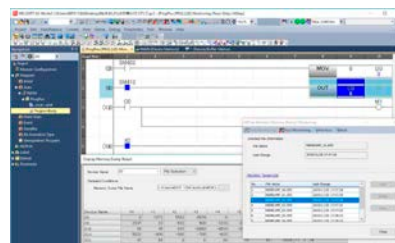

The data can also be checked on the program editor.

Caution

If the data protected by the file password function exists in the CPU module, backup/restore is disabled. When setting the security key authentication function, the program cannot be executed unless the security key has been written to the CPU module.

*1: While the backup/restore function is executed, some functions are temporarily unavailable. For details, refer to the manual.

*2: For the firmware version and software version of the corresponding CPU module, refer to page 62.

*3: Excluding the buffer memory of the intelligent function module.

*4: Supported by FX5U/FX5UC CPU module product number 16Y**** or later.

*5: The memory dump function and data logging function are not simultaneously available. There are some restrictions on the use of the backup/restore functions. For details, refer to the manual.

*6: For collectable data, refer to the manual.

Real-time monitoring function*

The contents of any devices can be monitored on real-time basis using GX LogViewer*. Because changes in device values are displayed in a trend graph, changes can be noticed at a glance!

The debugging efficiency is considerably improved at startup and troubleshooting. This function facilitates the resetting procedure, and enables graph check at a later time.

Real-time monitoring of data collected by CPU module using numerical values and graphs

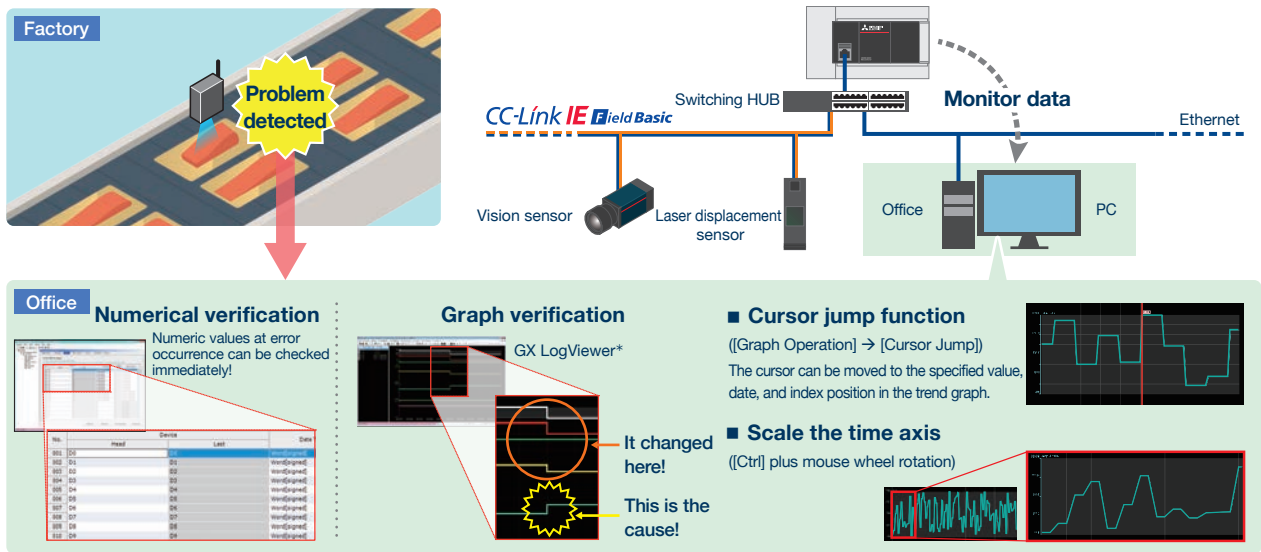

*: For the firmware version and software version of the corresponding CPU module, refer to page 62.



Function Introduction



Safety Control

Device safety is highly important amid the globalization of various industries and systems. The MELSEC iQ-F series also features a lineup of modules which complies with safety standards.

List of models

	Safety main module	Safety input expansion module
Safety extension module	 FX5-SF-MU4T5*	 FX5-SF-8DI4*
	<ul style="list-style-type: none">• Maximum number of connected modules: 1 module• Number of safety inputs: 4 points• Number of safety outputs: 4 points• Safety control programs: 9 types	<ul style="list-style-type: none">• Maximum number of connected modules: 2 modules• Number of safety inputs: 8 points• Safety control programs: 9 types

What is the safety extension module?

By using the safety extension module, it is possible to receive input from a safety input device (such as an emergency stop button or a light curtains) and turn the output OFF based on the calculation result of a safety control program when a hazard is detected. Thereby, the power to the hazard source (the moving part of a robot, conveyor, or similar device) will be interrupted. Malfunctions on the safety extension module can be detected by its self diagnostics, in which case the output is forcibly turned OFF. Hence the problem of malfunctions preventing the safety functions from operating does not occur.

**It's too late once an accident occurs!
Countermeasures must be implemented to prevent accidents!**

The MELSEC iQ-F series safety extension module has obtained certification (category 4, PL e, and SIL3) as being compatible with international safety standards and is designed for constructing safety control systems.

Certified as compatible with international safety standards

Category 4

PL e

SIL3



Easily create a system just by connecting a safety extension module

A safety control system can easily be installed just by connecting a safety main module (FX5-SF-MU4T5) to an FX5UJ/FX5U/FX5UC CPU module. This single system can then be used to perform general-purpose control and safety control. Therefore, there is no need for wiring such as the one needed for monitoring the safety status (as is necessary with a safety controller) or the wiring needed between relays when constructing a system with safety relays. Furthermore, the number of safety inputs can be expanded by connecting safety input expansion modules (FX5-SF-8DI4).

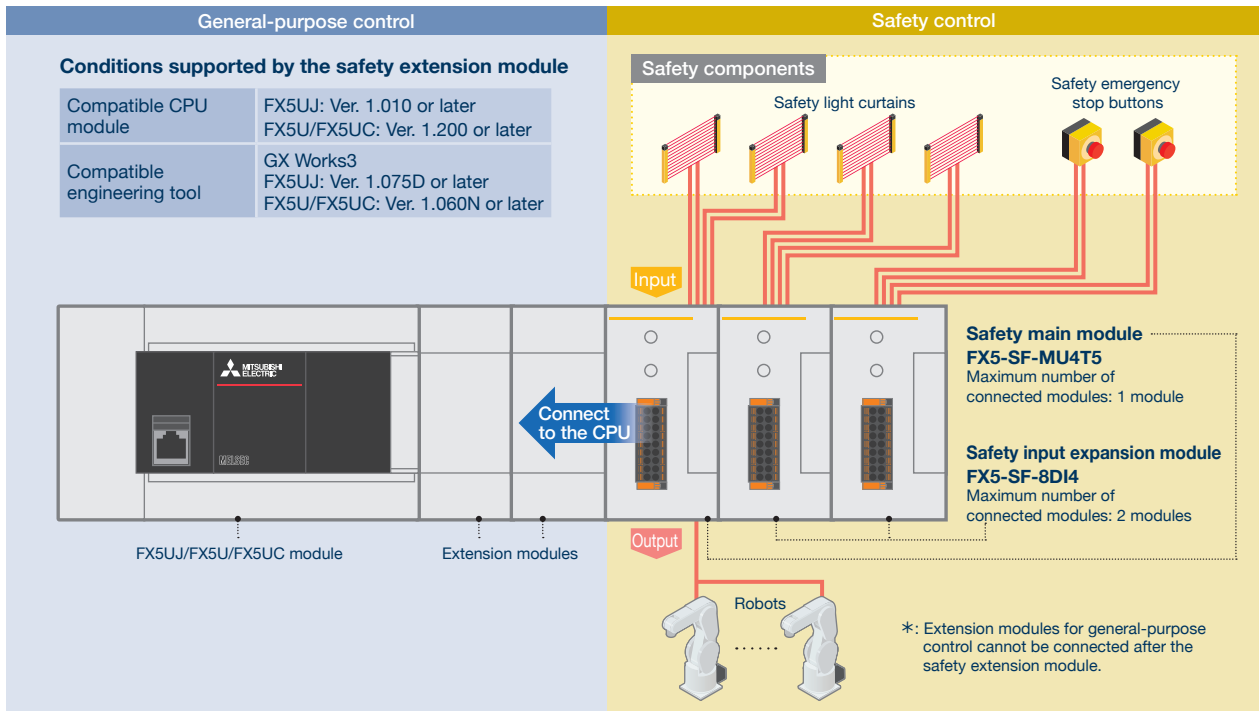

Turn the rotary switch to select the built-in program

Each safety extension module has nine types of built-in programs. To build a safety control system, just use the rotary switch on the front of the module to select the built-in program to run. This eliminates the need for sequence programs designed for safety control.

Just turn the switch with a precision screwdriver or a similar tool!
 Nine types of built-in programs!

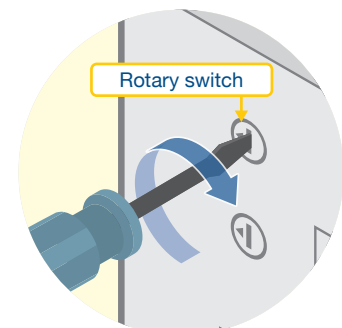
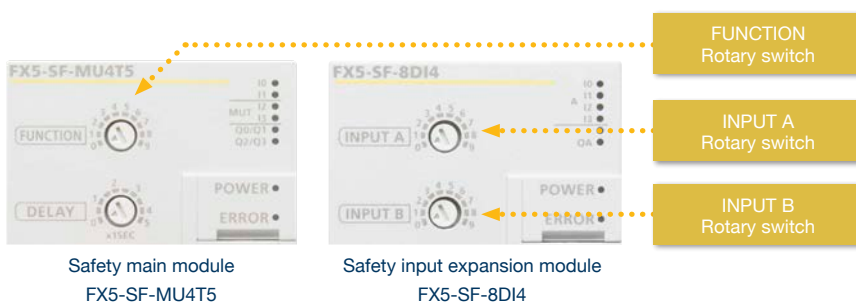

Program list

Program	Overview	
	FX5-SF-MU4T5	FX5-SF-8DI4
0	Inactive	Inactive
1	OR control (1)	AND link (single channel)
2	OR control (2)	AND link (dual channel) (1)
3	Muting control	AND link (dual channel) (2)
4	Two-hand control (1)	AND link (dual channel) (3)
5	Two-hand control (2)	AND link (dual channel) (4)
6	AND control (1)	AND link (dual channel) (5)
7	AND control (2)	OR link (dual channel)
8	Independent control	Bypass
9	AND control (3)	All paths batch connection



For details, refer to the above start guide.
 L(NA)08708ENG
 (Available only through PDF, and e-Manual distribution)

Function Introduction



Using the Safety Extension Module Configuration Guide to determine the wiring at a glance!

We have prepared the MELSEC IQ-F Series Safety Extension Module Configuration Guide to enable users to use the safety extension module. This configuration guide is a tool for easily checking the system configuration, settings, and wiring of the safety extension module.



- The configuration guide makes it possible to:**
- Check the connection terminals of the I/O devices.
 - Check the wiring diagram.
 - Check when the rotary switch was changed.
 - Print the created wiring diagram.

STEP 1
Place the safety extension module.

STEP 2
Click the device to connect.

STEP 3
Select the connection destination.

STEP 4
The set device is applied to the configuration.

The display of the program outline diagram changes to match the selected program number.

Set the program number with the rotary switch.

Click ▲ and ▼ to change the program number.

Module diagnosis with GX Works3, a useful function when problems occur!

Safety extension module information such as its I/O, settings, and error codes are stored in the buffer memory of the safety main module. The error history records up to 16 items. When an error occurs, information such as the error details and countermeasures can be checked from the module diagnosis function of GX Works3, which makes troubleshooting easier.

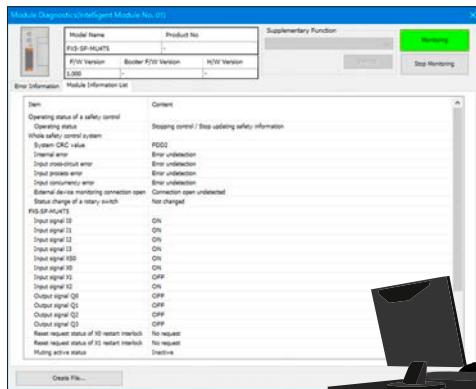
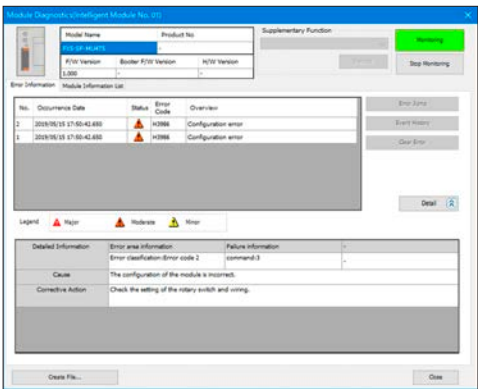
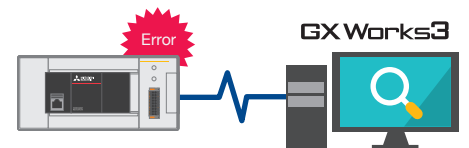

Module diagnostics screen examples

*: Please contact your local Mitsubishi Electric sales office or representative.

Enables visualization of the equipment status by linking safety extension modules with external devices!

Device linking using a GOT, the built-in function of the CPU module, or a similar method enables on-site workers to share information. Also, the safety status of devices can be monitored (including error monitoring and information collecting) over a network from an office or other such remote location.

GOT connection

Items such as the operating time, error information, and safety I/O ON/OFF information can be displayed on the GOT connected to the CPU module. Anyone can easily check the current operating status. For example, it is possible to quickly recover from a problem when an emergency stop occurs by displaying the cause of the problem on the screen.

Web server function*1

This function can be used to monitor, change, and diagnose errors in devices and buffer memory from general-purpose Web browsers (such as Internet Explorer® 11, Google Chrome, and Safari®) installed on tablet terminals and PCs connected to the same network. The status of devices can be checked from remote locations.

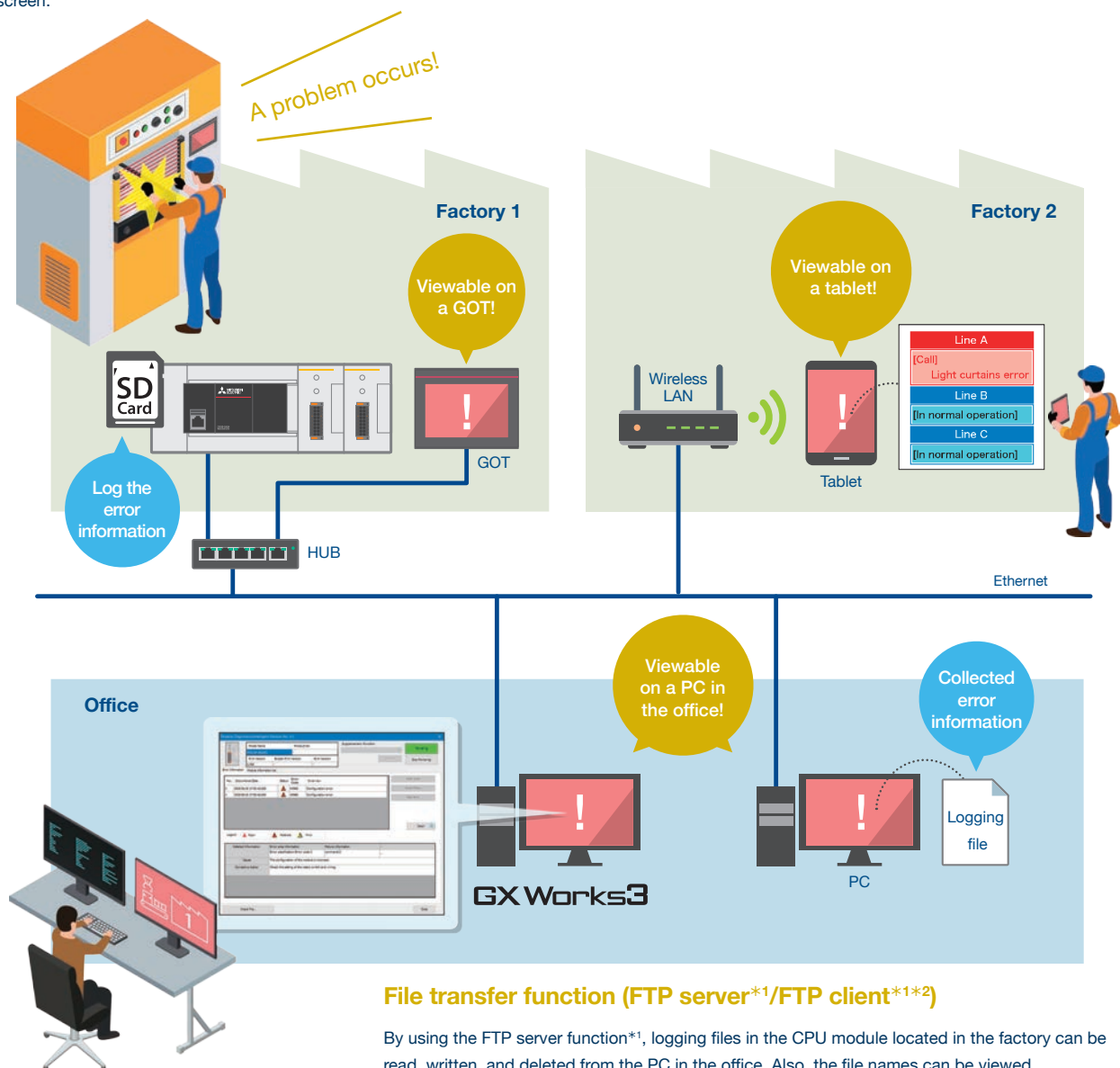

File transfer function (FTP server*1/FTP client*1*2)

By using the FTP server function*1, logging files in the CPU module located in the factory can be read, written, and deleted from the PC in the office. Also, the file names can be viewed.

By using the file transfer function command of the FTP client function*1*2, files in the FX5U/FX5UC CPU module located in the factory can be transferred (sent) to the PC in the office.

This makes it possible to perform various operations from the PC in the office such as analyzing the causes of problems using the collected data.

*1: For the firmware version and software version of the corresponding CPU module, refer to page 62.
*2: Supported only by the FX5U/FX5UC CPU module.



Analog Control

The analog amount (voltage, current, etc.) can be input or output using analog input modules, analog output modules and analog input/output modules.

Use the ample lineup of extension modules for analog control that matches your applications.

List of models

	3 ch	4 ch	8 ch
Analog input	<p>2 ch</p> <p>1 ch</p> <p>FX5U CPU module</p>	<p>2 ch</p> <p>FX5UJ FX5U FX5UC</p> <p>2 ch</p> <p>FX5UJ FX5U FX5UC</p> <p>NEW</p> <p>FX5-4A-ADP</p> <p>4 ch</p> <p>FX5UJ FX5U FX5UC</p> <p>FX5-4AD-ADP</p> <p>FX5UJ FX5U FX5UC</p> <p>FX5-4AD*1</p> <p>FX5UJ FX5U FX5UC</p> <p>FX3U-4AD*2</p>	<p>FX5UJ FX5U FX5UC</p> <p>FX5-8AD*1</p> <p>[8 ch] multi input (Selectable in channels)</p> <ul style="list-style-type: none"> • Voltage • Current
Analog output		<p>FX5UJ FX5U FX5UC</p> <p>FX5-4DA-ADP</p> <p>FX5UJ FX5U FX5UC</p> <p>FX5-4DA*1</p> <p>FX5UJ FX5U FX5UC</p> <p>FX3U-4DA*2</p>	
Temperature/temperature control		<p>Temperature sensor input</p> <p>FX5UJ FX5U FX5UC</p> <p>For thermocouple</p> <p>FX5-4AD-TC-ADP</p> <p>FX5UJ FX5U FX5UC</p> <p>For resistance temperature detector</p> <p>FX5-4AD-PT-ADP</p> <p>Temperature control</p> <p>4 ch</p> <p>FX5UJ FX5U FX5UC</p> <p>FX5-4LC*1</p> <p>[4 ch] temperature input (Selectable in channels)</p> <p>[4 ch] transistor output</p> <ul style="list-style-type: none"> • Two-position control • Heating-cooling control • PID control • Cascade control <p>4 ch</p> <p>FX5UJ FX5U FX5UC</p> <p>FX3U-4LC*2</p> <p>[4 ch] temperature input (Selectable in channels)</p> <p>[4 ch] transistor output</p> <ul style="list-style-type: none"> • Two-position control • Heating-cooling control • PID control • Cascade control 	<p>FX5UJ FX5U FX5UC</p> <p>FX5-8AD*1</p> <p>[8 ch] multi input (Selectable in channels)</p> <ul style="list-style-type: none"> • Resistance temperature detector (Pt100, Ni100) • Thermocouple (K, J, T, B, R, S)

*1: Connection with FX5UC CPU module requires FX5-CNV-IFC or FX5-C1PS-5V.

*2: Connection with FX5U/FX5UC CPU module requires FX5-CNV-BUS or FX5-CNV-BUSC.

Analog input/output (with alarm output) control using built-in function

The FX5U CPU module has built-in 12-bit 2 ch analog voltage input*1 and 1 ch analog voltage output. Programs are not required. Only parameter settings are enough for analog control. Numerical shift, scaling setting, and alarm output setting can also be easily set with parameters.

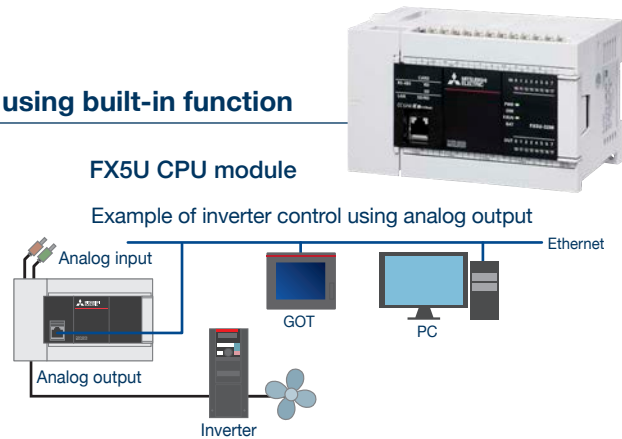

Improved performance, and compact size*2!

Conversion speed “80 μs/ch” realized

4AD 4DA

Both the analog input module and the analog output module have realized the conversion speed as fast as 80 μs/ch, which has considerably improved compared with conventional modules.

● Analog input module



● Analog output module

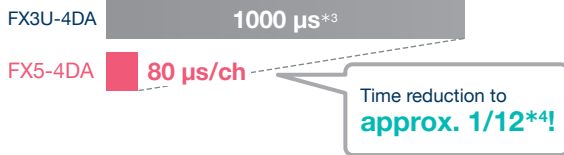

Analog input module FX5-4AD
Analog output module FX5-4DA



Analog processing of higher accuracy

4AD 4DA

Analog input and analog output realize high resolution. The analog processing of higher accuracy has been enabled.



Data collection at high-speed: a maximum of 80 μs.

4AD

The data-logging function enables the ability to collect continuously changing analog values at the specified intervals or at any time.

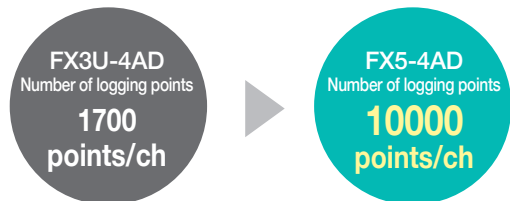
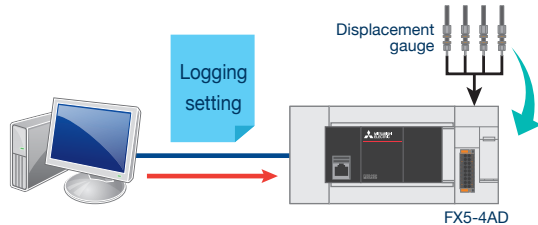

The waveform output function achieves smooth waveform output without depending on scan time.

4DA

- The operator can easily create graphical waveform output data expressed in arcs and straight lines using GX Works3.
- The operator can update analog output values in the D/A conversion cycle (80 μs at highest speed) without depending on the scan time.
- The operator can register the waveform output data in the analog output module, and repeatedly use them to reduce the man-hours for programming.

● With analog output using the waveform output function

An analog value is output at a constant interval.

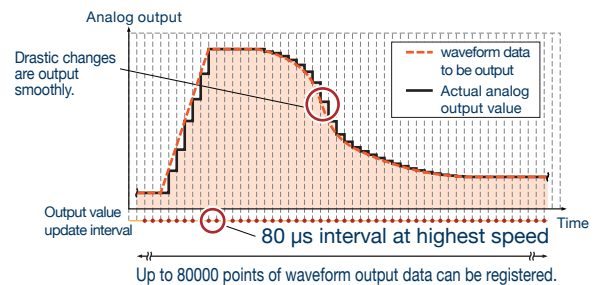

Wave closer to the waveform to be output can be obtained!

*1: Can be used as current input. For usage, refer to the manual.
*2: When compared with Mitsubishi Electric FX3U-4AD and FX3U-4DA.
*3: 1000 μs without regard to the number of channels.

*4: In the case of 1 ch use.
*5: When the ambient temperature is 25±5°C, and the “-10 to +10 V” range is selected.

Function Introduction



Analog Control

Voltage, current, thermocouple, and resistance temperature detector inputs can be used for multiple applications with a single module!



Multiple input module FX5-8AD

Providing support for various applications

Voltage, current, thermocouple (K, J, T, B, R, S), and resistance temperature detector (Pt100, Ni100) inputs are supported.

Possible to set input type per channel!

Analog input Total 8 channels

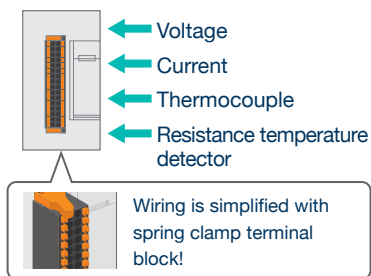

Easily detect disconnection

Thermocouple and resistance temperature detector disconnection can be easily detected, so downtime and maintenance cost can be reduced.

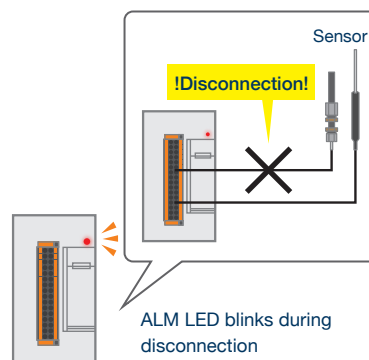

Analyze problems with logging function

10000 points of data per channel can be logged and stored to buffer memory.

If the log is saved, it can be useful in investigating the cause of the problem.

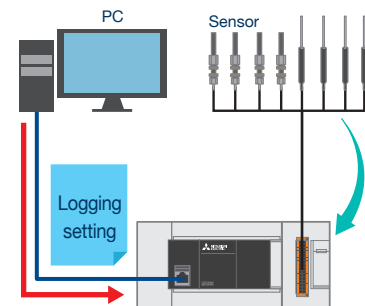

4-channel input/output compatible temperature control is possible!



Temperature control module FX5-4LC

Various temperature sensors can be used

This module handles input from thermocouples, low voltage, and temperature measuring resistors. Possible to support a variety of applications.

Possible to set input type per channel!

Temperature sensor input Total 4 channels (isolation between channels)

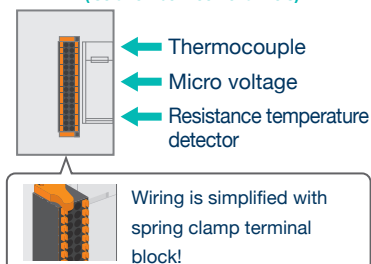

PID control supported

Overshooting where the output value exceeds the target value, and hunting phenomenon where vibration occurs around the target value can be suppressed.

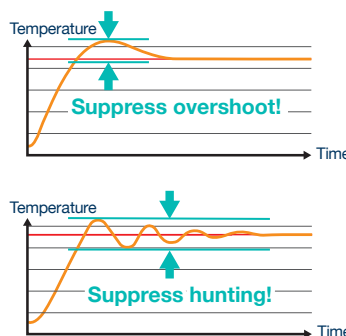

Temperature trace supported

Temperature change can be checked on a waveform. While checking the temperature waveform displayed in real-time, parameters can be adjusted.

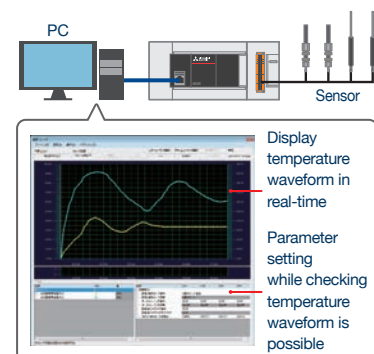

memo



Positioning Control

The CPU module has a built-in positioning function. Complex multi-axis and interpolation control can be performed using the positioning module and simple motion module.

List of models

	1 axis	2 axes	3 axes	4 axes	8 axes
CPU module (built-in positioning), high-speed pulse I/O module		FX5U FX5UC FX5-16ET/ES-H*1, FX5-16ET/ESS-H*1 • Simple linear interpolation (Start 2 axes simultaneously)	 FX5UJ CPU module (Transistor output type only)	 FX5U/FX5UC CPU module (Transistor output type only) • Simple linear interpolation (Start 2 axes simultaneously)	
Positioning module	FX5U FX5UC FX3U-1PG*2	FX5UJ FX5U FX5UC FX5-20PG-P*1 FX5-20PG-D*1 • Linear interpolation, circular interpolation		FX5U FX5UC FX5-40SSC-G*1 • Linear interpolation, circular interpolation • Synchronous control, cam control, torque control	FX5U FX5UC FX5-80SSC-G*1 • Linear interpolation, circular interpolation • Synchronous control, cam control, torque control
Simple motion module				FX5UJ FX5U FX5UC FX5-40SSC-S*1*3 • Linear interpolation, circular interpolation • Synchronous control, cam control, torque control	FX5UJ FX5U FX5UC FX5-80SSC-S*1*3 • Linear interpolation, circular interpolation • Synchronous control, cam control, torque control

Built-in positioning function (200 kpps, 3-axis/4-axis built-in)

FX5UJ/FX5U/FX5UC CPU module



CPU modules (only the transistor output type) are equipped with the high-speed counter function with 8 channels for high-pulse inputs and built-in positioning function using 4-axis*4 pulse outputs.

In addition to conventional functions, such as interrupt stop operations and variable speed operations, new functions are added, making the built-in positioning function easier to use.

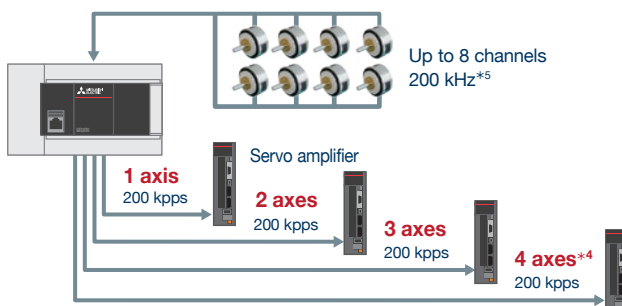

[Example of box-packing machine using the positioning function built in the FX5U CPU module]

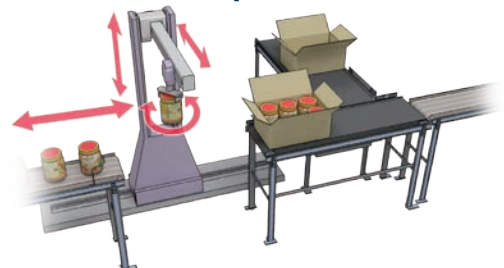

*1: Connection with FX5UC CPU module requires connector conversion module (FX5-CNV-IFC) or extension power supply module (FX5-C1PS-5V).
 *2: Connection with FX5U/FX5UC CPU module requires FX5-CNV-BUS or FX5-CNV-BUSC.
 *3: Only one module can be connected to the system when connected to the FX5UJ CPU module.
 *4: Three axes in the FX5UJ CPU module.
 *5: 6 ch 200 kHz + 2 ch 10 kHz only for FX5U-32M and FX5UC-32M.

Realizes multi-axis control at reasonable cost using the FX5U/FX5UC CPU module and high-speed pulse I/O modules



High-speed pulse input/output module FX5-16ET/ES-H, FX5-16ET/ESS-H

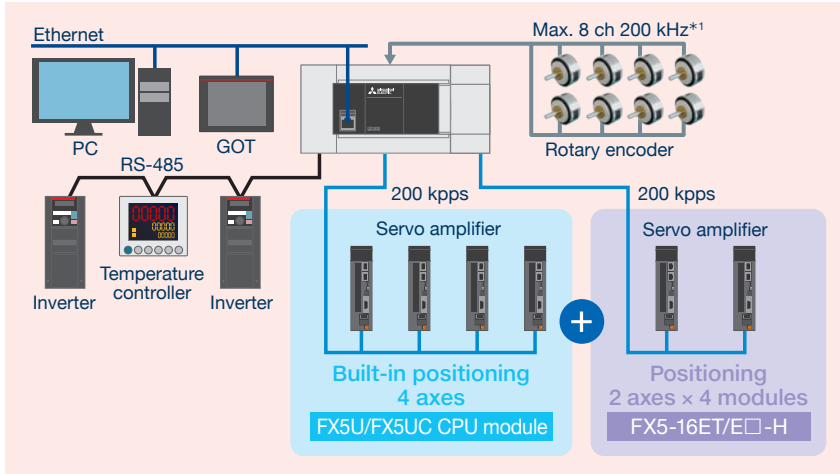

FX5U/FX5UC CPU module 4 axes
 + FX5-16ET/ES-H
 + 2 axes x 4 modules = 8 axes

Total of 12 axes of control is possible!



Faster startup and 2-axis positioning for increased flexibility!

2-axis pulse train positioning module FX5-20PG-P (Transistor output)
 FX5-20PG-D (Differential driver output)

Either of two types of products is selectable according to the system.

Regarding positioning modules, a transistor output type and a differential line driver output type are available.



Transistor output type
 FX5-20PG-P



Differential driver output type
 FX5-20PG-D

The maximum output pulse is 5 M pulse/s, and the connection distance is 10 m.*2

With maximum output pulses of 5 M pulse/s for the FX5-20PG-D, control is possible for devices with higher resolutions than conventional products. The maximum connection distance between servos is 10 m.

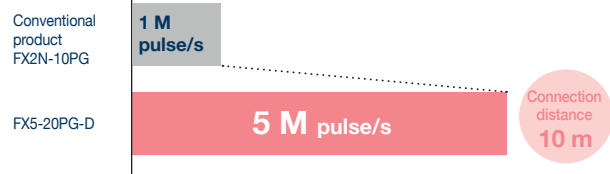

High-speed start realized

The high-speed normal positioning starting process speed can shorten the starting time to 0.5 ms.

■ Comparison of starting times for 1-axis linear control

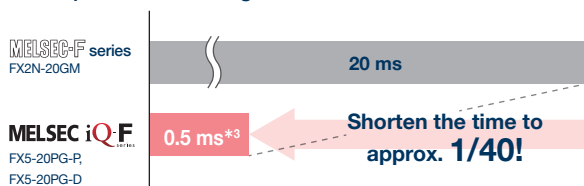

Quick start function supported

By analyzing positioning data in advance, positioning can be started at a high-speed of maximum 20 μs.

■ Comparison of starting times



*1: 6 ch 200 kHz + 2 ch 10 kHz only for FX5U-32M and FX5UC-32M.
 *2: For FX5-20PG-P, the maximum pulse output is 200 k pulse/s, and the maximum connection distance is 2 m.
 *3: 1-axis linear control/1-axis speed control. For other controls, refer to the manual.
 *4: Start by external command signal. 30 μs in the case of start by positioning start signal.

Function Introduction



Positioning Control

Motion module (4/8-axis control module) NEW

CC-Link IE TSN



Motion module (4/8-axis control module) FX5-40SSC-G, FX5-80SSC-G

Positioning control with CC-Link IE TSN

The motion module is equipped with the 4/8-axis positioning function compatible with CC-Link IE TSN. It can be connected with the MELSERVO-J5 series of high-performance servo amplifiers, which ensure advanced positioning control. The programs of the conventional simple motion modules can be used, so the number of labor-hours for programming can be reduced.

Minimum operation cycle 500 μ s



Main functions
<ul style="list-style-type: none"> • Linear interpolation • Circular interpolation • Continuous path control • S-curve acceleration/ deceleration

Application examples
<ul style="list-style-type: none"> • Packaging equipment • Printing equipment • Material processing equipment

List of applicable motion modules

Supported network	Number of connectable module	Number of connectable module	Number of connectable module	Supported servo amplifier
CC-Link TSN	FX5UJ Not supported	FX5U Up to 4 modules*	FX5UC Up to 4 modules*	MELSERVO-J5

Simple motion module (4/8-axis control module)

SSCNET III/H
SERVO SYSTEM CONTROLLER NETWORK



Simple motion module (4/8-axis control module) FX5-40SSC-S, FX5-80SSC-S

Positioning control with SSCNET III/H

The simple motion module is equipped with the 4/8-axis positioning function compatible with SSCNET III/H. It can be used for various purposes by combining linear interpolation, 2-axis circular interpolation, constant quantity feed, and continuous path control in a table-based program.

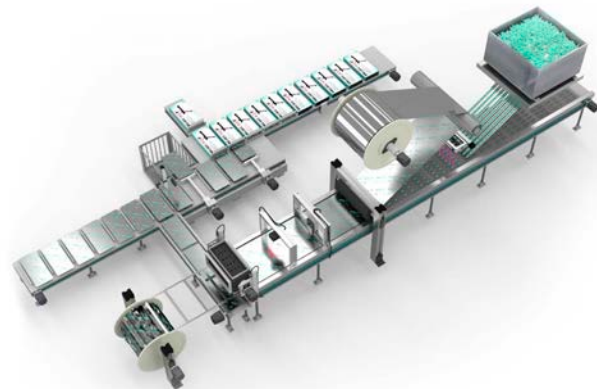

Main functions
<ul style="list-style-type: none"> • Linear interpolation • Circular interpolation • Continuous path control • S-curve acceleration/ deceleration

Application examples
<ul style="list-style-type: none"> • Sealing system • Palletizer • Grinding system

List of applicable simple motion modules

Supported network	Number of connectable module	Number of connectable module	Number of connectable module	Supported servo amplifier
SSCNET III/H	FX5UJ Up to 1 module	FX5U Up to 16 modules	FX5UC Up to 15 modules	MELSERVO-J4

*: Up to four modules of the FX5-40SSC-G, FX5-80SSC-G, and FX5-CCLGN-MS (master station) in total

Making motion module, and simple motion module with compactly packed extra functions

By starting with parameter settings and the sequence program, the motion modules, and simple motion modules can realize a variety of motion control including positioning control, advanced synchronous control, cam control, and speed-torque control.

Synchronous control

In addition to synchronous control by replacing hardware mechanisms such as gears, shafts, transmissions, and cams with software, functions such as cam control, clutch, and cam auto generation can be easily realized. Each axis can be started and stopped by synchronization control. Synchronously-controlled axes and positioning-controlled axes can exist together.

Up to 4 axes*1 can be synchronized to the synchronous encoder axis, enabling use with a variety of systems.

☑ Motion module ☑ Simple motion module

- Synchronous control and cam control can be used to build a system perfect for your equipment.
- Up to 64 types*2 of cam patterns can be registered to respond quickly to any type of contents.
- Continuous operation can be performed without stopping the workpiece.

● Example of press printing machine

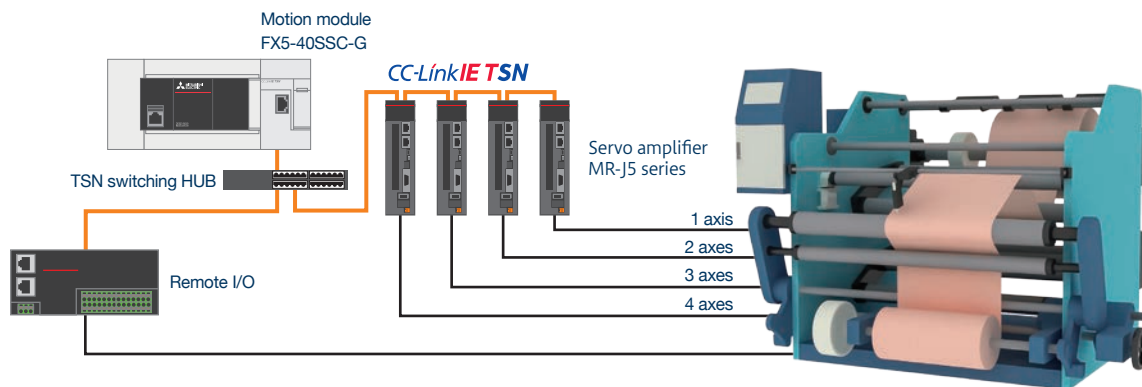

● Example of vertical pillow packaging machine

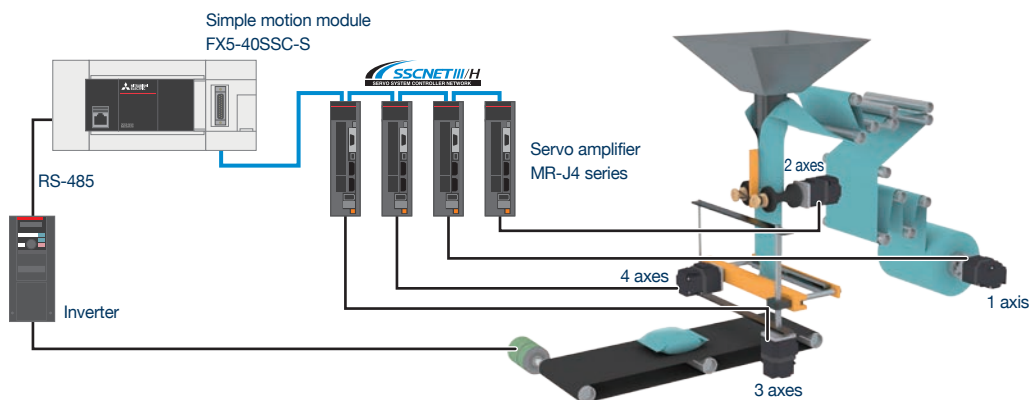

*1: FX5-80SSC-G, FX5-80SSC-S: 8 axes

*2: FX5-40SSC-G, FX5-80SSC-G, FX5-80SSC-S: 128 types

Function Introduction



Positioning Control

Mark detection function

☑ Motion module ☑ Simple motion module

The cutter axis deviation can be compensated by detecting a mark on the workpiece so the workpiece can be cut at a constant position.

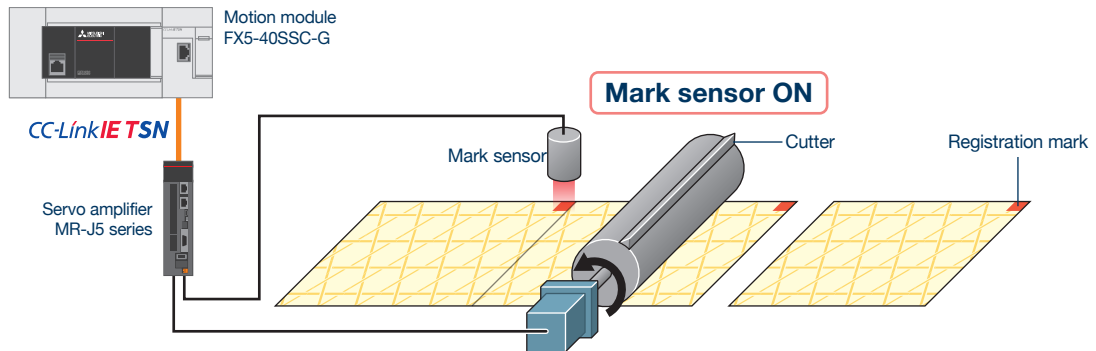

Cam data auto-generation

☑ Motion module ☑ Simple motion module

Cam data of the rotary cutter, which was conventionally difficult to create, can be automatically generated simply by inputting sheet length, synchronization width, cam resolution, etc.

Also, saving the cam data in the cam save area enables continuous use of the last cam data even after power-off, and thus can shorten the start-up time of the system and realize multi-product production.

Item		FX5-40SSC-G	FX5-80SSC-G	FX5-40SSC-S	FX5-80SSC-S
Memory capacity	Cam save area	128 k bytes		64 k bytes	128 k bytes
	Cam load area	1024 k bytes		1024 k bytes	
Max. number of registrations*	Cam save area	Up to 128		Up to 64	Up to 128
	Cam load area	Up to 256		Up to 256	

User-created GOT screen



Parameter settings, including items like sheet length, etc.

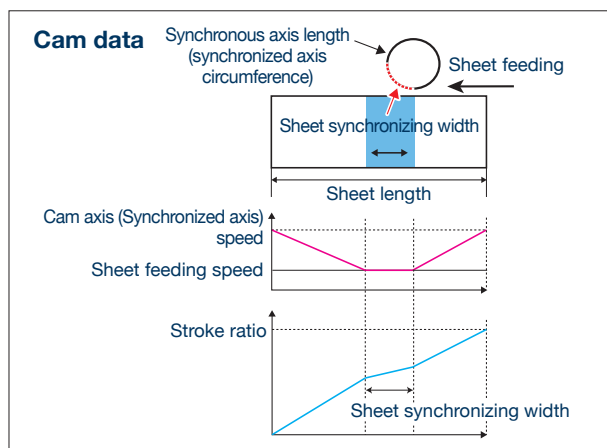

*: The maximum number of registered cams varies depending on the memory capacity, cam resolution, and the number of coordinates. For details, refer to the manual.

Various driving equipment

☑ Motion module ☑ Simple motion module

Not only rotary servo motors but also linear servo motors, direct drive motors, inverter FR-A800 series, and partner maker equipment can be connected.

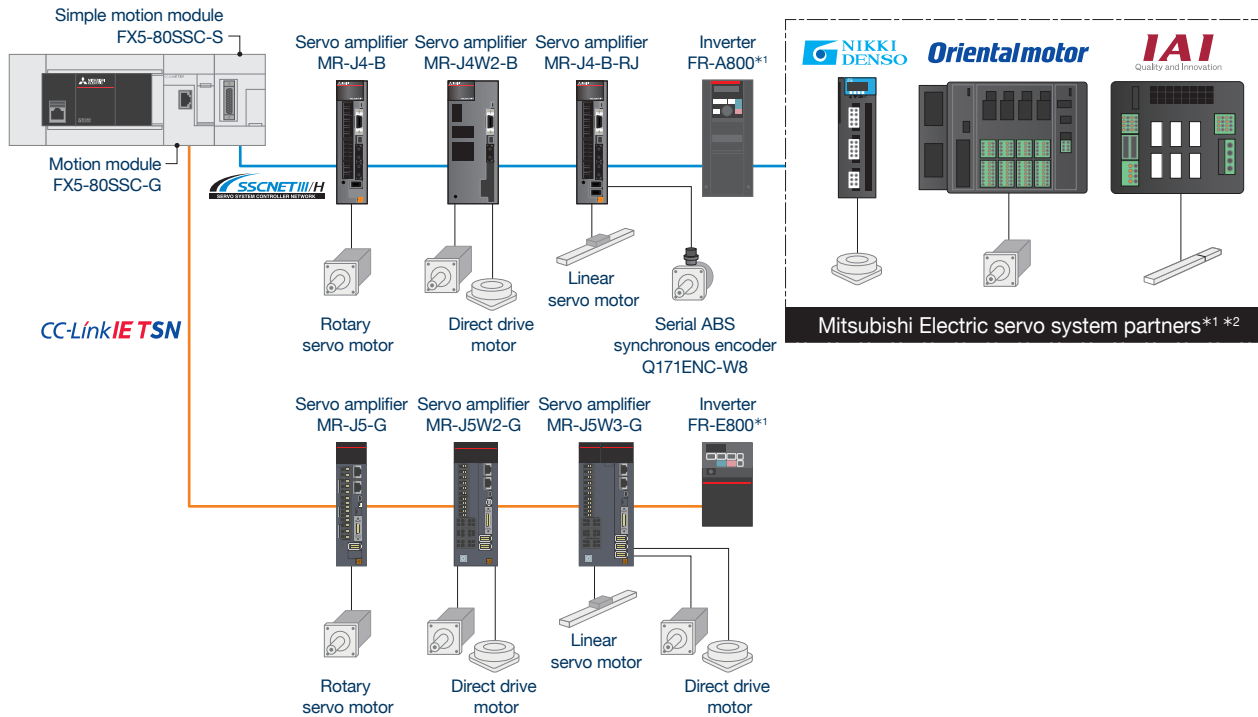

*1: For partner products and inverter FR-A800 and FR-E800, use the versions compatible with the motion module and simple motion module.





*2: For details of partner products, refer to the servo system partner product catalog. Only the FX5-40SSC-S and FX5-80SSC-S can be connected with the Mitsubishi Electric Servo System Partner.



High-Speed Counter Function

The CPU module has a built-in high-performance, high-speed counter, enabling high-speed control with a simple program. Channels can be added using high-speed pulse I/O modules.

List of models

		Number of channels	Input format/ input voltage	Type/max. frequency
CPU module (Built-in high-speed counter)	 FX5UJ CPU module	Max. 8 ch	Open collector 24 V DC	1-phase 1-input 100 kHz* ¹
		1-phase 1-input 100 kHz 4 ch 10 kHz 4 ch		1-phase 2-input 100 kHz* ¹ [multiplied by 1]
CPU module (Built-in high-speed counter)	 FX5U/FX5UC CPU module	Max. 8 ch	Open collector 24 V DC	1-phase 1-input 200 kHz* ¹
		FX5U-32M□/FX5UC-32M□ 1-phase 1-input 200 kHz 6 ch 10 kHz 2 ch		1-phase 2-input 200 kHz* ¹ [multiplied by 1]
High-speed pulse input/output module	 FX5U-16ET/ES-H* ² , FX5-16ET/ESS-H* ²	Max. 2 ch	Open collector 24 V DC	1-phase 1-input 200 kHz
				1-phase 2-input 200 kHz [multiplied by 1]
High-speed counter block	 FX3U-2HC* ³	Max. 2 ch	Open collector 5 V DC / 12 V / 24 V Differential line driver 5 V DC	2-phase 2-input 100 kHz [multiplied by 2]
				2-phase 2-input 50 kHz [multiplied by 4]

*1: The max. frequency varies according to the high-speed counter. Refer to the MELSEC iQ-F FX5 User's Manual (Application).

*2: Connection with FX5UC CPU module requires connector conversion module (FX5-CNV-IFC) or extension power supply module (FX5-C1PS-5V).

*3: Connection with FX5U/FX5UC CPU module requires FX5-CNV-BUS or FX5-CNV-BUSC.

The built-in high-speed counter can count the number of inputs of high-speed pulses

FX5UJ/FX5U/FX5UC CPU module



The FX5UJ/FX5U/FX5UC CPU module is equipped with the high-speed counter function with 8 ch for high-speed pulse inputs.

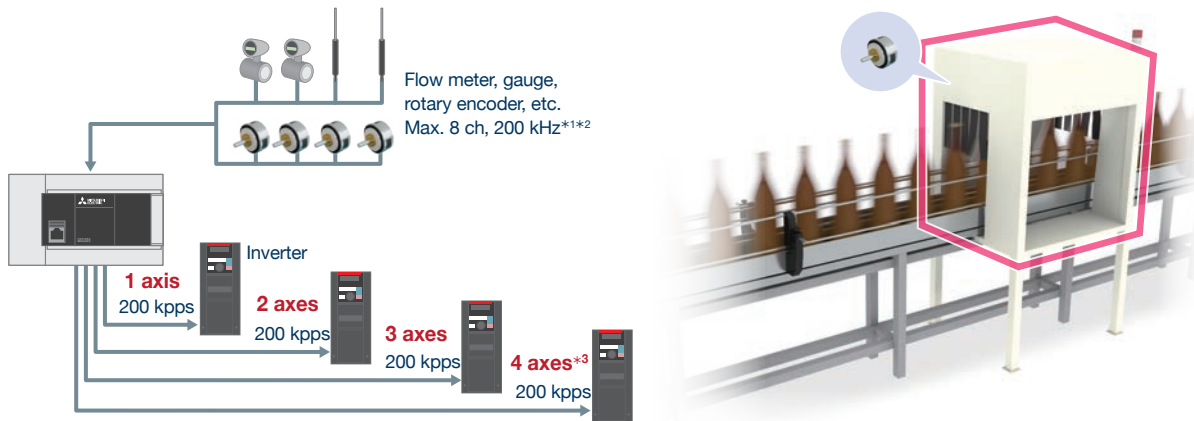

The number of high-speed counter channels can be extended easily

High-speed pulse I/O module FX5-16ET/ES-H, FX5-16ET/ESS-H

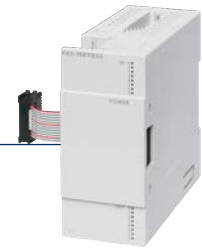

High-speed pulse inputs at up to 16 ch are available when high-speed pulse I/O modules are connected to the built-in high-speed counter.

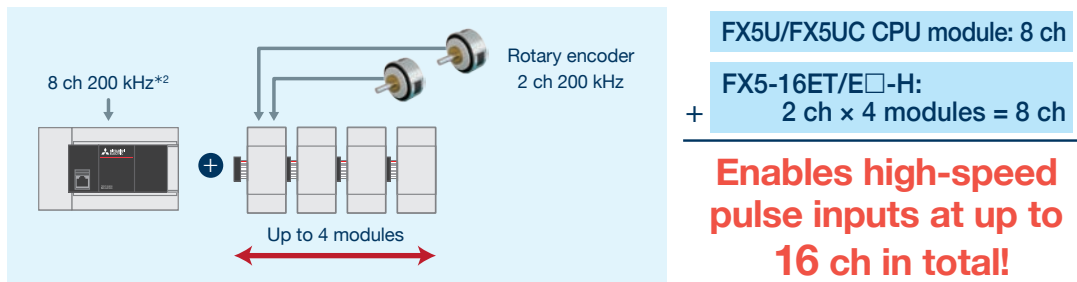

The high-speed counter function and positioning function can be used together!

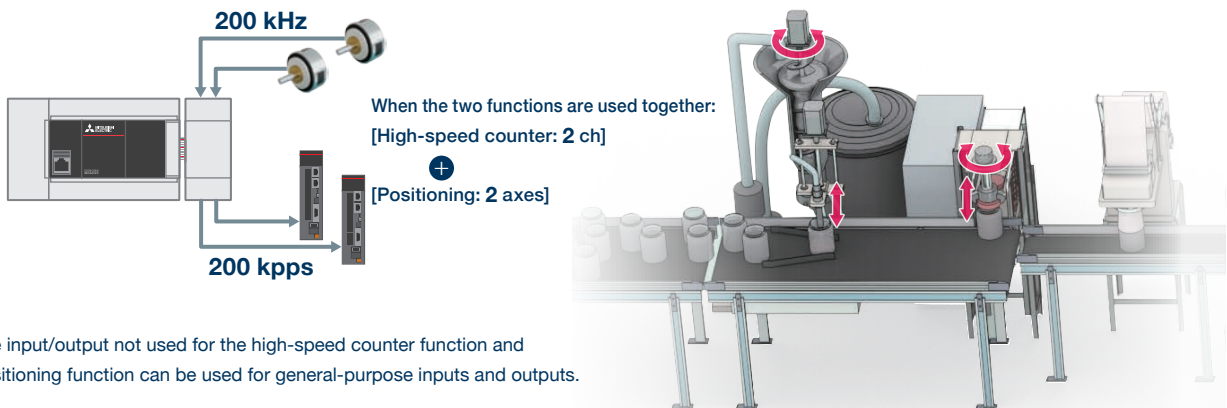

The input/output not used for the high-speed counter function and positioning function can be used for general-purpose inputs and outputs.

*1: 4 ch, 100 kHz + 4 ch, 10 kHz for the FX5UJ CPU module.
*2: 6 ch, 200 kHz + 2 ch, 10 kHz for the FX5U-32M and FX5UC-32M.
*3: Up to 3 axes for the FX5UJ CPU module.



Network/Communication/Information-sharing

The MELSEC iQ-F series can perform communication with various networks in accordance with the application.

CC-Link IE TSN	P36	Sensor Solution (AnyWireASLINK)	P44
CC-Link IE Field Network	P37	PROFIBUS-DP	P45
CC-Link IE Field Network Basic	P38	MODBUS (MODBUS/RTU / MODBUS/TCP)	P46
CC-Link V2	P39	Serial communication	P47
Ethernet	P40	<Information-sharing>	
EtherNet/IP	P42	OPC UA	P48
BACnet	P43	Station type list	P49

■ CC-Link IE TSN



List of models



What is CC-Link IE TSN?

This is an Ethernet-based open integrated network that connects seamlessly from the information system to the production site. By utilizing CC-Link IE TSN that adopts the TSN (Time Sensitive Networking) technology, integration of control communication and information communication essential to realization of a smart factory can be achieved in one network.

Can be connected to CC-Link IE TSN

CC-Link IE TSN enables coexistence of information communication with the IT system and cyclic communication where the real-time property is assured.

The FX5-CCLGN-MS module enables connection of the FX5U/FX5UC CPU module as a master station or local station of CC-Link IE TSN. One FX5-CCLGN-MS module can perform both CC-Link IE TSN communication and TCP/IP communication without any interference in the same network, resulting to lower system cost and higher efficiency.

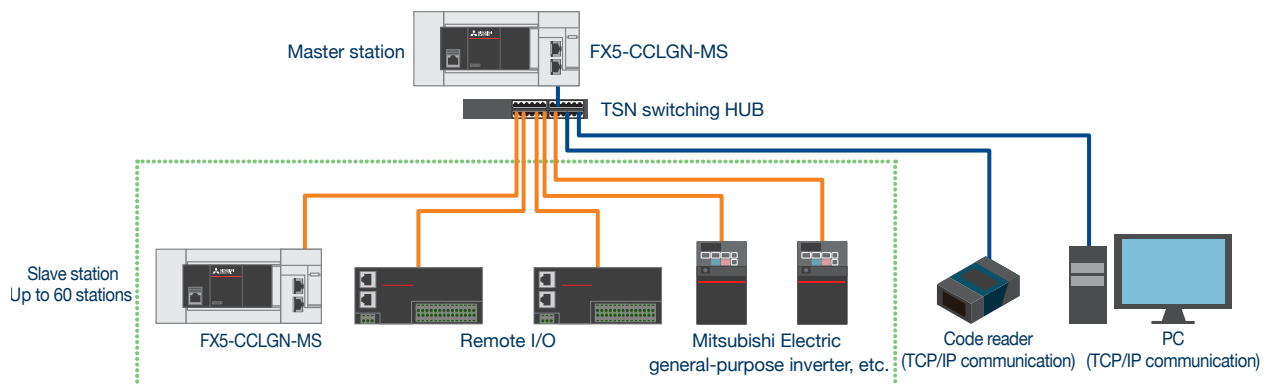

*1: Connection with FX5UC CPU module requires connector conversion module (FX5-CNV-IFC) or extension power supply module (FX5-C1PS-5V).
 *2: For the corresponding station types and CPU modules, refer to page 49.

■ CC-Link IE Field Network

CC-Link IE Field

List of models



What is CC-Link IE Field Network?

CC-Link IE Field Network is an Ethernet-based open field network that covers a wide range from high-speed I/O control to controller distribution control in one network, and achieves wiring with high degree of freedom in accordance with the device layout.

Controller distribution, I/O control, motion control, safety function, etc. can be set seamlessly.

Can be connected to CC-Link IE Field Network

The FX5-CCLIEF module enables connection of the CPU module as an intelligent device station of CC-Link IE Field Network.

The FX5-CCLIEF module offers flexible wiring methods including ring type, star type, and line type, reduces the wiring cost, and improves reliability.

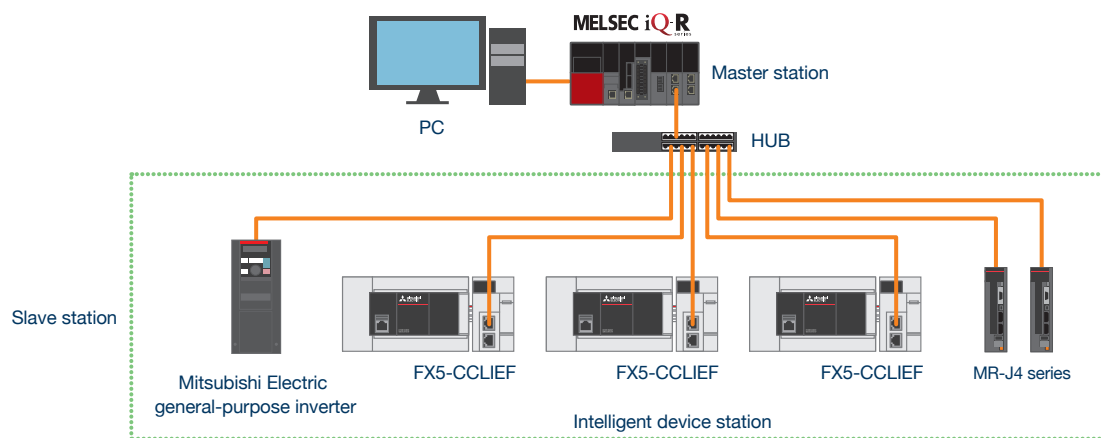

*1: Connection with FX5UC CPU module requires connector conversion module (FX5-CNV-IFC) or extension power supply module (FX5-C1PS-5V).

*2: For the corresponding station types and CPU modules, refer to page 49.

Function Introduction



Network/Communication/Information-sharing

■ CC-Link IE Field Network Basic

CC-Link IE Field Basic

List of models



What is CC-Link IE Field Network Basic?

CC-Link IE Field Network Basic is an FA network utilizing a general-purpose Ethernet. It enables cyclic communication that assures punctuality when only software is mounted. It supports construction of a network for small-scale devices not requiring high-speed control.

Can be connected to CC-Link IE Field Network Basic

The CPU module is equipped with the master station function for CC-Link IE Field Network Basic, and can connect up to 16 slave stations*3. When the FX5-ENET module*4 is connected, CC-Link IE Field Network Basic can be extended furthermore.

Because remote I/O stations connected to CC-Link IE Field Network Basic are not included*5 in the total number of remote I/O points, remote I/O stations can be extended without considering the number of remote I/O points.

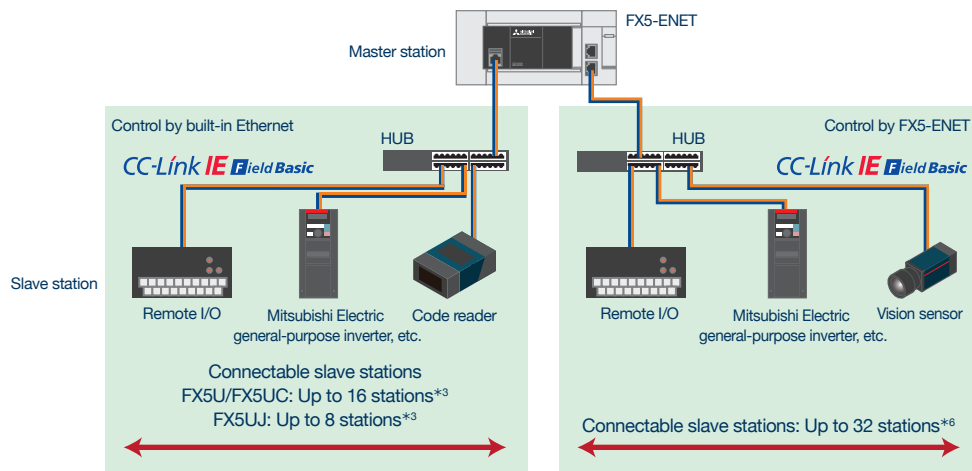

*1: Connection with FX5UC CPU module requires connector conversion module (FX5-CNV-IFC) or extension power supply module (FX5-C1PS-5V).

*2: For the corresponding station types and CPU modules, refer to page 49.

*3: Up to 16 occupied stations in total to the FX5UC CPU module, and up to 8 occupied stations in total to the FX5UJ CPU module.

*4: Only one FX5-ENET module can be connected to the system.

*5: Supported by the FX5U/FX5UC CPU module Ver. 1.110 or later and product number 17X**** (product number 178**** for the FX5UC-32MT/DS-TS and FX5UC-32MT/DSS-TS) or later, and GX Works3 Ver. 1.050C or later.
Up to 6 stations to the FX5U/FX5UC CPU module Ver. 1.110 or earlier.

*6: The number of connectable stations varies depending on the number of occupied slave stations.

■ CC-Link V2



List of models



What is CC-Link V2?

CC-Link V2 is a global-standard open field network that assures high performance in I/O control for connection among field devices. It enables data sending and receiving of large capacity and high punctuality.

Can be connected to CC-Link V2

Enables building network systems compatible with CC-Link V2 at low cost. Since FX5-CCL-MS has both functions, the master station and intelligent device station, it can be used as either of them by switching with parameters.

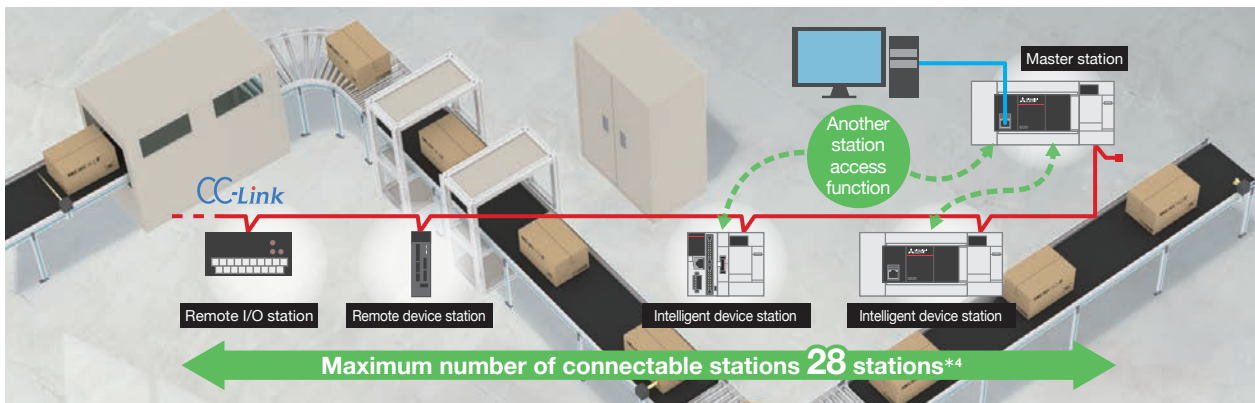

Other station access function supported

Perform program write/read and device monitoring, etc. for another station's PLC within the same network using the GX Works3 connected to own station.

There's no need to connect GX Works3 and perform programming for each MELSEC iQ-F series module, so programming man-hours can be reduced.

Equipped with master station/ intelligent device station functions

The FX5-CCL-MS module is equipped with both the master station function and the intelligent device station function, and can be used as either station when switched by a parameter.

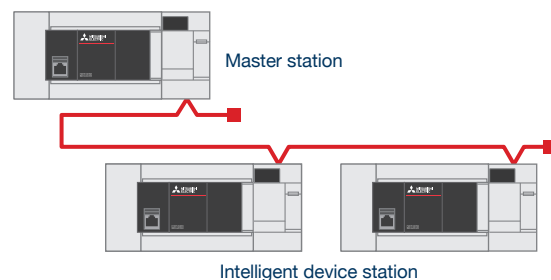

*1: Connection with FX5UC CPU module requires connector conversion module (FX5-CNV-IFC) or extension power supply module (FX5-C1PS-5V).
 *2: Connection with FX5U/FX5UC CPU module requires FX5-CNV-BUS or FX5-CNV-BUSC.
 *3: For the corresponding station types and CPU modules, refer to page 49.
 *4: When FX5-CCL-MS is added to the FX5U/FX5UC CPU module. When the FX5UJ CPU module or FX3U-16CCL-M is used, the maximum number of connectable stations is different from the number shown above. For details, refer to the manual.

Function Introduction



Network/Communication/Information-sharing

Ethernet

List of models



What is Ethernet?

Ethernet is a technical standard for control networks that perform communication between the site and the factory, and connect among FA devices. Communication with various FA devices is enabled, and IoT factories can be realized by using CPU modules equipped with Ethernet ports or using extension modules compatible with Ethernet ports.

Communication using Ethernet

Built-in Ethernet communication

Compatible models: CPU module / FX5-ENET / FX5-ENET/IP

Supports CC-Link IE Field Network Basic, FTP server, FTP client, and other protocols, and enables configuration of communication settings easily with parameters.

Also supports various functions such as the GX Works3 diagnostic function, SLMP communication function, socket communication function, and IP address change function, and prevents unauthorized accesses from the outside by remote passwords.

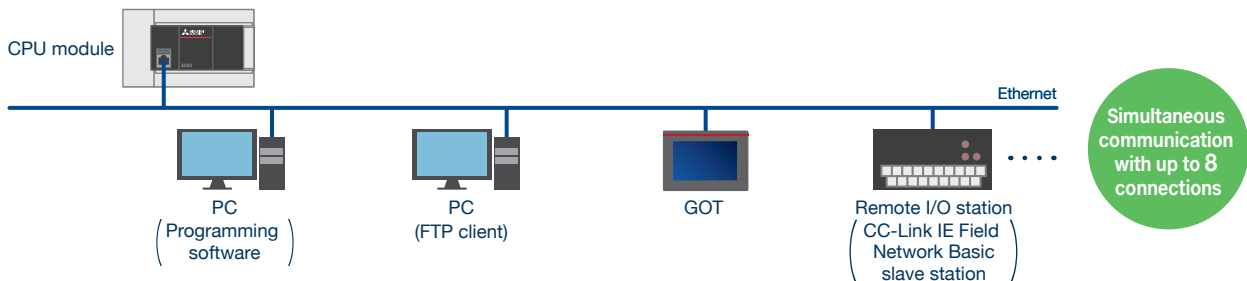

Simple CPU communication function*2

Compatible models: CPU module / FX5-ENET / FX5-ENET/IP

Using a simple parameter setting with GX Works3, device data such as production data can be transferred without any program.

The FX5U/FX5UC CPU module can easily perform communication with existing systems that use MELSEC iQ-R series, Q series or L series, or Another company's PLC.

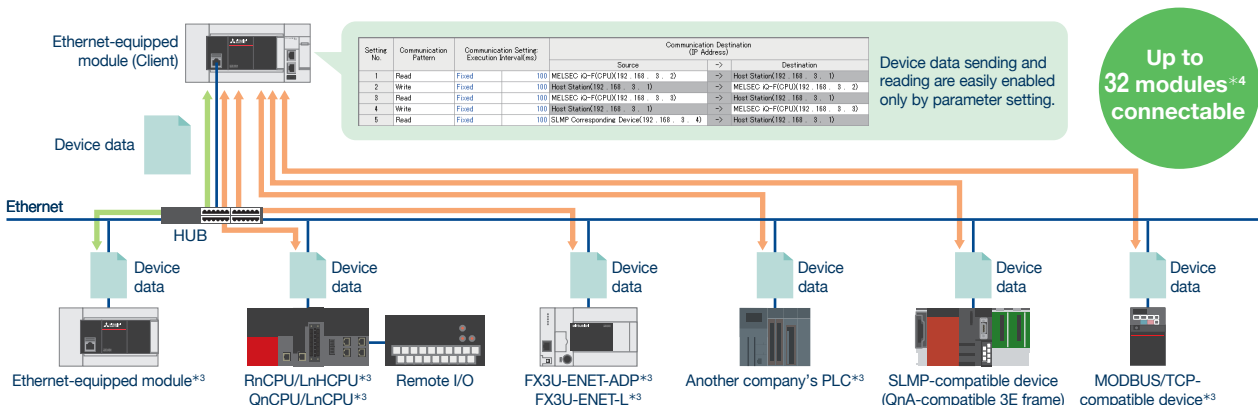

*1: Connection with FX5UC CPU module requires connector conversion module (FX5-CNV-IFC) or extension power supply module (FX5-C1PS-5V).

*2: For the firmware version and software version of the corresponding CPU module, refer to page 62.

*3: The devices with which the module can communicate vary depending on the Ethernet-equipped module (client) used. For details, refer to the manual.

*4: When the FX5-ENET or FX5-ENET/IP is used. Up to 16 FX5U/FX5UC CPU module can be connected. Up to 8 FX5UJ CPU modules can be connected.

SLMP communication

Compatible models: CPU module / FX5-ENET / FX5-ENET/IP

Device data stored in the Ethernet-equipped module can be read and written from the personal computer using the common protocol SLMP*1 (3E/1E*2*3 frame). Devices can be monitored from anywhere in the office or work site.

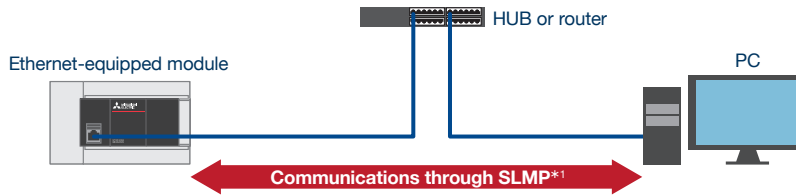

Remote maintenance

Compatible models: CPU module / FX5-ENET / FX5-ENET/IP

GX Works3 can be connected via VPN, and programs can be read/written. Troubleshooting can be performed from a remote place without going to the site, which leads to a reduction in maintenance costs.

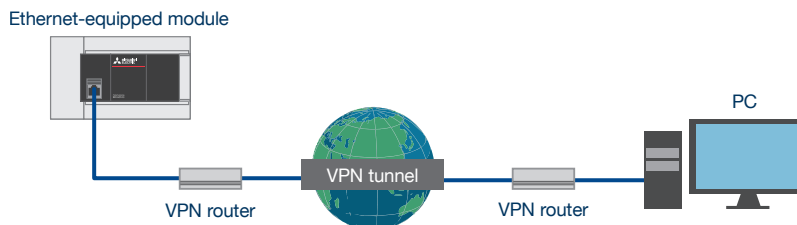

Socket communication function

Compatible models: CPU module / FX5-ENET / FX5-ENET/IP

Data communication with Ethernet-connected devices is possible via TCP or UDP.

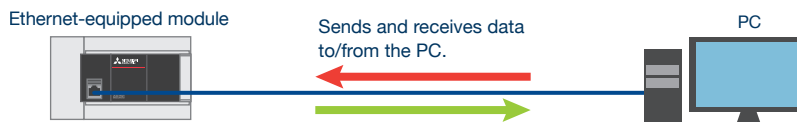

Web server function*3

Compatible models: CPU module / FX5-ENET / FX5-ENET/IP

Accessing the Web server from a Web browser on a PC enables CPU module monitoring and diagnosis without any dedicated tools. User Web pages*2*3 unique for each user can also be created.

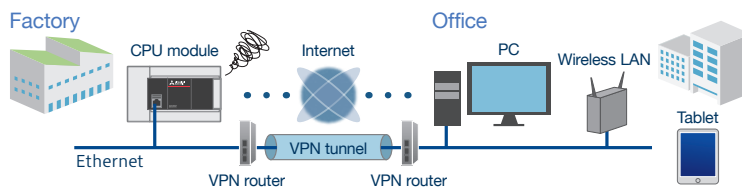

For details, refer to the start guide shown at right.



L(NA)08643ENG

L(NA)08645ENG

Displays on the system Web page.

Review errors using a Web browser

Displays on the user Web page.*2*3

With the user web page drawing tool, you can create web pages combining parts.

Select parts, and then drag & drop.

*1: SeamLess Message Protocol
 *2: FX5UJ CPU module is not compatible.
 *3: For the firmware version and software version of the corresponding CPU module, refer to page 62.

Function Introduction



Network/Communication/Information-sharing

EtherNet/IP

List of models



What is EtherNet/IP?

EtherNet/IP is an open network using the CIP communication protocol. It supports both controller-level networks and device-level networks, and can be used together with a general-purpose Ethernet.

Can be connected to an EtherNet/IP network

The FX5-ENET/IP module realizes seamless communication with an EtherNet/IP network using the dedicated setting tool. EtherNet/IP communication and general-purpose Ethernet communication can coexist.

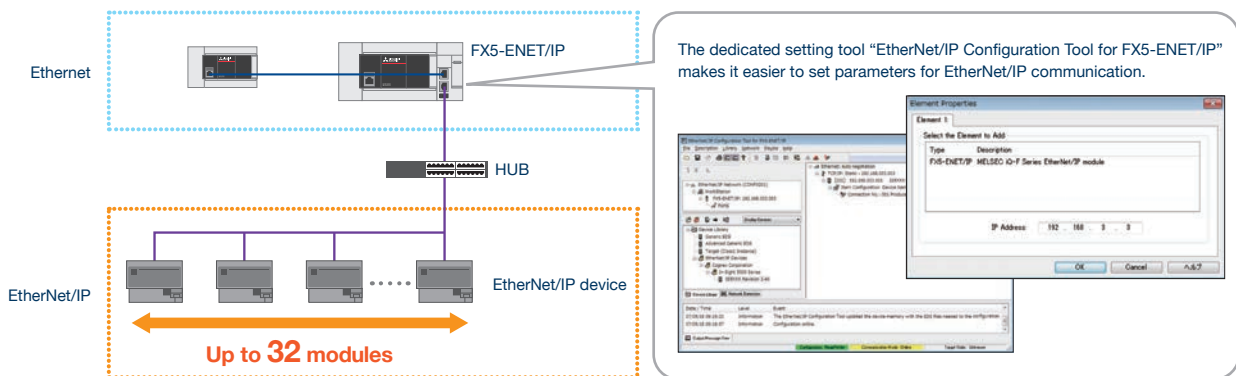

+ONE Enables communication using general-purpose Ethernet

FX5-ENET/IP enables communication using an Ethernet connection. For functions, refer to page 40 to page 41.

*: Connection with FX5UC CPU module requires connector conversion module (FX5-CNV-IFC) or extension power supply module (FX5-C1PS-5V).

BACnet

List of models

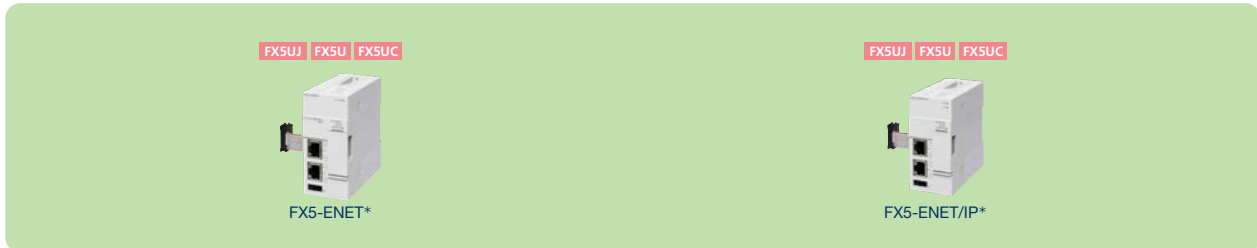

What is BACnet?

BACnet is an open communication standard for building networks established in 1995 by ASHRAE (American Society of Heating, Refrigerating and Air-Conditioning Engineers).

Can be connected to an BACnet

FX5-ENET and FX5-ENET/IP using the BACnet/IP function operate as BACnet devices in the BACnet system. The BACnet devices can communicate data with the BACnet workstation and BACnet controller. The BACnet/IP function can be implemented together with other general Ethernet protocols.

BACnet standards

Item	FX5-ENET, FX5-ENET/IP		
Profile (Role)	B-ASC		
Supported standards	·ANSI/ASHRAE Standard 135-2016 ·ANSI/ASHRAE Standard 135-2004	·ANSI/ASHRAE Standard 135-2012 ·IEIEJ-G-0006:2006 Addendum-a	·ANSI/ASHRAE Standard 135-2010

BACnet system

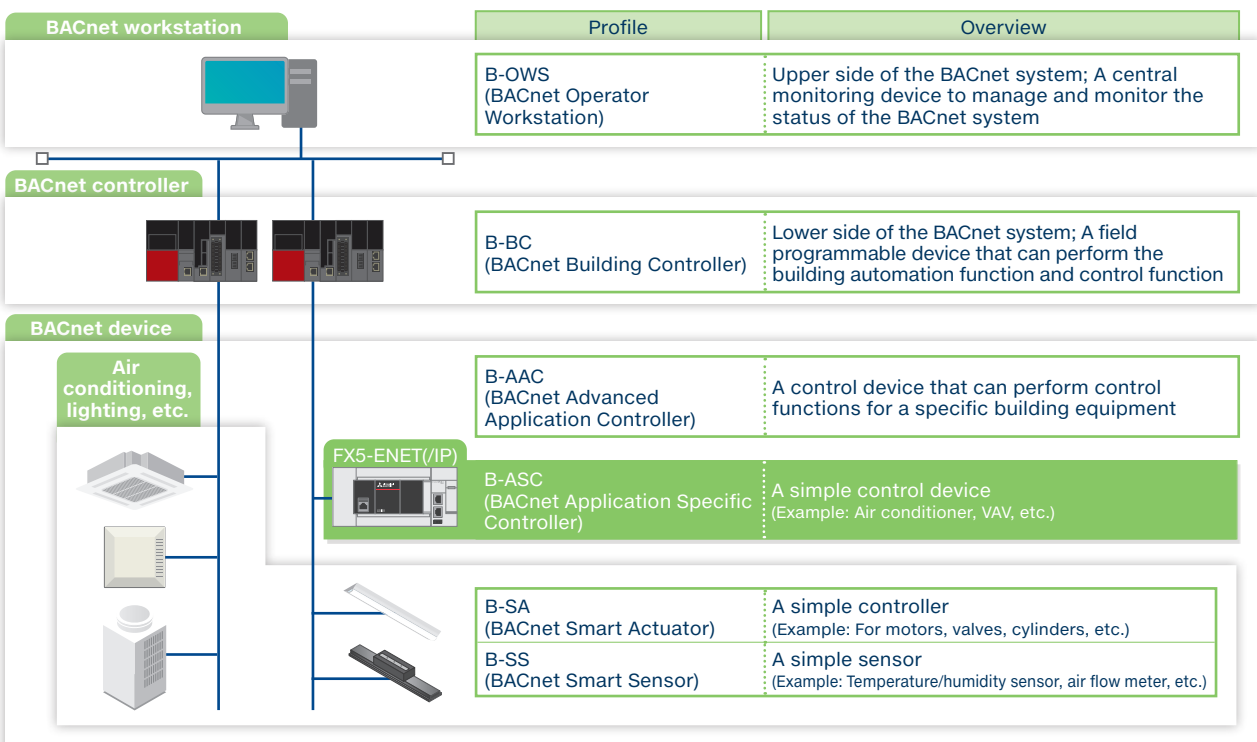

*: Connection with FX5UC CPU module requires connector conversion module (FX5-CNV-IFC) or extension power supply module (FX5-C1PS-5V).

Function Introduction



Network/Communication/Information-sharing

■ Sensor Solution (AnyWireASLINK)

AnyWireASLINK

List of models [AnyWireASLINK]



What is AnyWireASLINK?

AnyWireASLINK is a flexible sensor network that realizes wiring saving and man-hour reduction using highly usable small remote I/O modules, and status monitoring and preventive maintenance using sensors directly connected to the network.

Can be connected to AnyWireASLINK system

Can be connected to the AnyWireASLINK system made by Anywire Corporation "Visualization" of sensors has been strengthened by collaboration with sensors and Mitsubishi Electric FA products.

It is useful for preventive maintenance such as sensor disconnection detection.

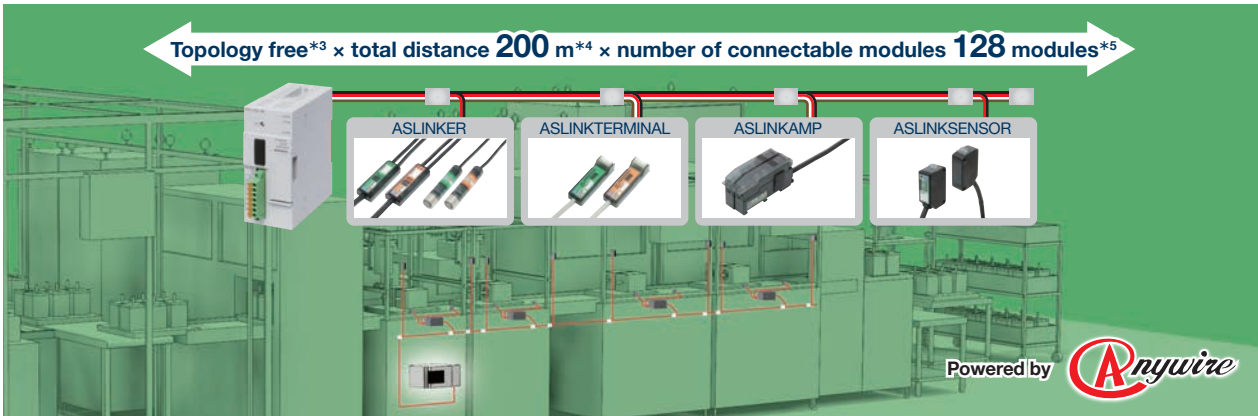

*1: Connection with FX5UC CPU module requires connector conversion module (FX5-CNV-IFC) or extension power supply module (FX5-C1PS-5V).
*2: Connection with FX5U/FX5UC CPU module requires FX5-CNV-BUS or FX5-CNV-BUSC.
*3: There is no regulation about such as the specification of branching method and minimum distance between terminals.
*4: Total extension distance including branch line length.
*5: The number varies depending on current consumption of each slave module.

PROFIBUS-DP

List of models

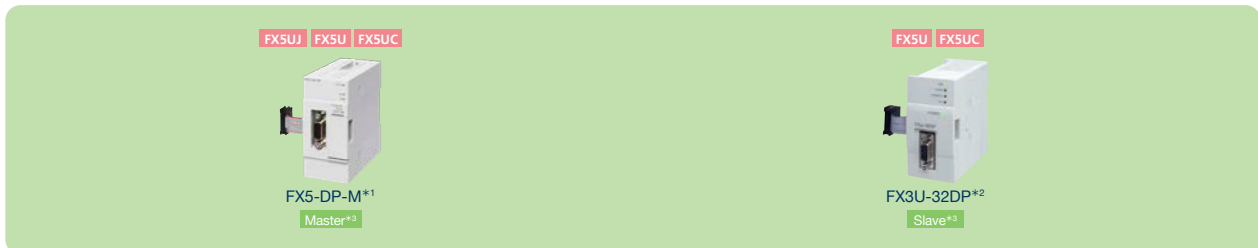

What is PROFIBUS-DP?

PROFIBUS-DP is an industrial field bus developed and maintained by PROFIBUS & PROFINET International (PI). PROFIBUS is used in a wide range of fields mainly in Europe.

Can be connected to PROFIBUS-DP

When used as the PROFIBUS-DP master station, the FX5-DP-M module can integrate PROFIBUS-compatible slave stations into the system. The protocol enables high-speed data transfer between a field device (such as remote I/O module and drive) and a controller.

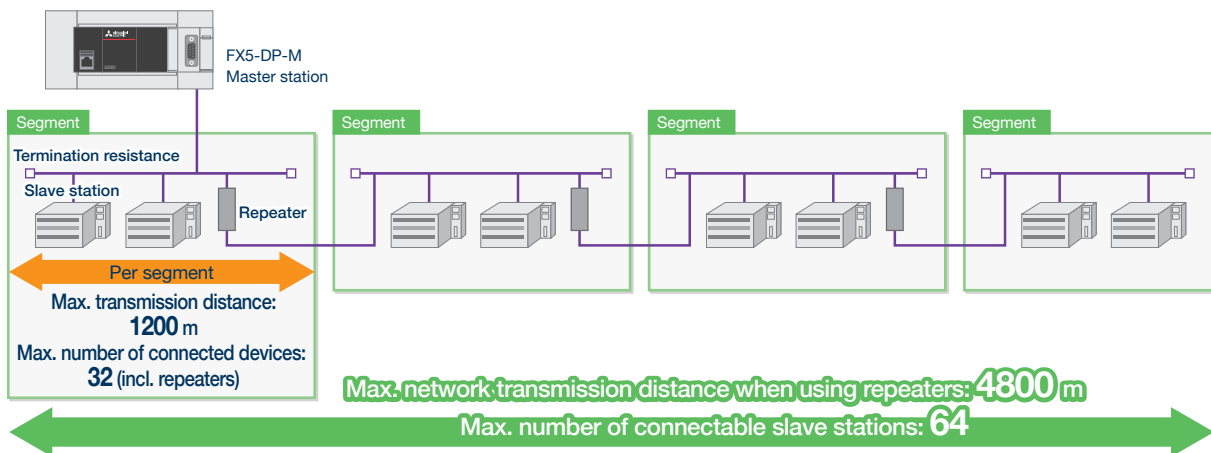

Max. 12 Mbps high-speed, large-capacity communication

High-speed communication is possible at up to 12 Mbps.
Up to 64 slave stations per FX5-DP-M for I/O connections.
Data transmission is possible at up to 2048 bytes (with a max. of 244 bytes of I/O data per slave station).

Obtain communication failure information from slave stations

Using the buffer memory makes it possible to obtain communications error information or extended communications error information generated by a slave station during I/O data transmission.

Reading/writing I/O data

I/O data can be read/written between a CPU module device and the FX5-DP-M buffer memory.
To read or write I/O data, configure the refresh settings on the PROFIBUS Configuration Tool, or use MOV instruction or FROM/TO instruction programs.

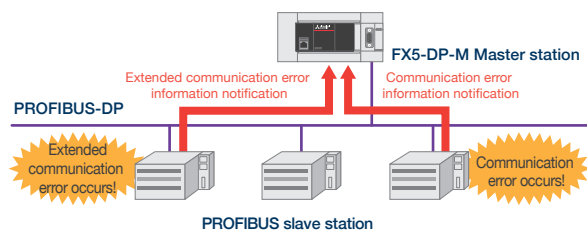

*1: Connection with FX5UC CPU module requires connector conversion module (FX5-CNV-IFC) or extension power supply module (FX5-C1PS-5V).
*2: Connection with FX5U/FX5UC CPU module requires bus conversion module (FX5-CNV-BUS or FX5-CNV-BUSC).
*3: For the corresponding station types and CPU modules, refer to page 49.

Function Introduction



Network/Communication/Information-sharing

MODBUS

List of models [MODBUS/RTU]

<p>FX5U/FX5UC CPU module (Built-in RS-485 port)</p> <p>Master* Slave*</p>	<p>FX5-232ADP</p> <p>Master* Slave*</p>	<p>FX5-485ADP</p> <p>Master* Slave*</p>	<p>FX5-232-BD</p> <p>Master* Slave*</p>	<p>FX5-485-BD</p> <p>Master* Slave*</p>
---	---	---	---	---

List of models [MODBUS/TCP]

FX5UJ/FX5U/FX5UC CPU module
(Built-in Ethernet port)

Master* Slave*

What is MODBUS?

MODBUS is a communication network for FA devices. There are two types, MODBUS/RTU and MODBUS/TCP. MODBUS/RTU is a network for data transfer using binary data, and MODBUS/TCP is a network based on Ethernet (TCP/IP). MODBUS/RTU uses an RS-485 or RS-232C port. MODBUS/TCP uses a built-in Ethernet port.

MODBUS/RTU communication

FX5 CPU module can connect, as a master or slave station of MODBUS communication, to various MODBUS communication devices.

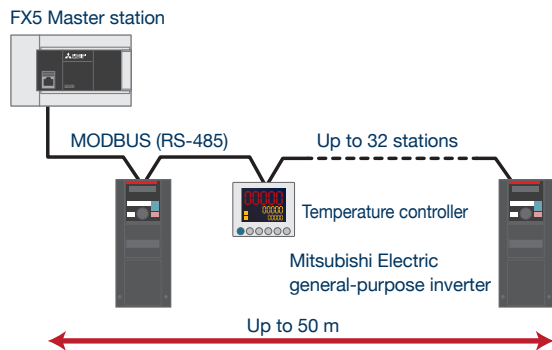

MODBUS/TCP communication

The FX5 CPU module used as a slave station can be connected to various MODBUS/TCP master devices connected through Ethernet. When the FX5 CPU module is used as the master station, it uses the simple CPU communication function or the communication protocol support function to control the slave stations.

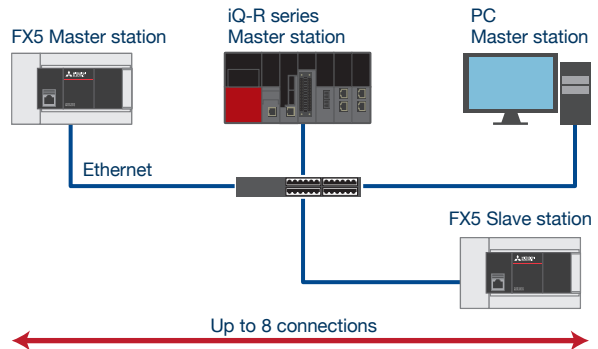

*: For the corresponding station types and CPU modules, refer to page 49.

Serial communication

List of models



What is serial communication?

Serial communication is a communication method for connecting the PLC and FA devices via RS-232C or RS-485. One communication port enables one type of serial communication. Various types of serial communication can be used simultaneously by adding communication ports.

Communication using RS-232C or RS-485 equipment

Parallel link function*1

This function connects two CPU modules and automatically links mutual device data. ON/OFF status and data register values of the other station can be checked.

Normal parallel link mode/high-speed parallel link mode can be selected depending on the desired number of link points and link time. Parallel link can only be used on one channel of the CPU module.

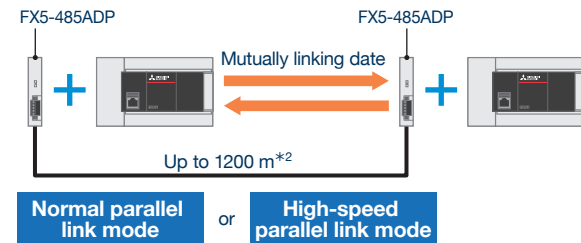

Non-protocol communication

Non-protocol serial communication can be performed with RS-232C/RS-485 interface devices such as code readers, printers, personal computers, and measuring instruments.

RS-232C expansion board and built-in RS-485 port



N:N Network

In this communication, a connection is set up with the FX5 PLC or FX3 PLC through RS-485 communication to automatically exchange data.

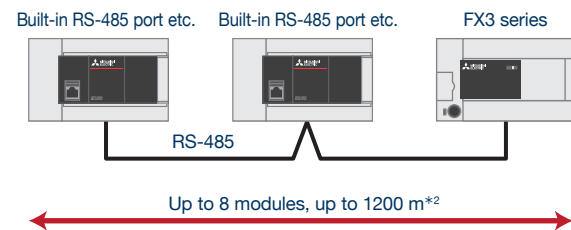

Inverter communication

Up to 16 inverters can be operated and controlled by RS-485 communication.

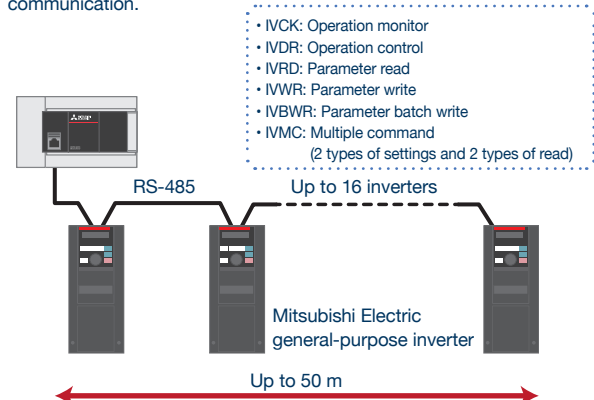

*1: For the firmware version and software version of the corresponding CPU module, refer to page 62.
*2: 50 m or less when the built-in RS-485 port and FX5-485-BD are included.

Information-sharing

■ OPC UA



List of models



OPC UA communication is enabled.



What is OPC UA?

OPC UA (OPC Unified Architecture) is a platform-independent communication protocol developed by the OPC Foundation, USA. It can realize safe and reliable data communication between the production level and host IT system.

A highly reliable system can easily be built.

The use of the OPC UA module eliminates the need for a PC-based OPC UA server with high-security risk such as virus infection and improves reliability. The OPC UA security functions, such as certificate, encryption, and signing, can be set optionally.

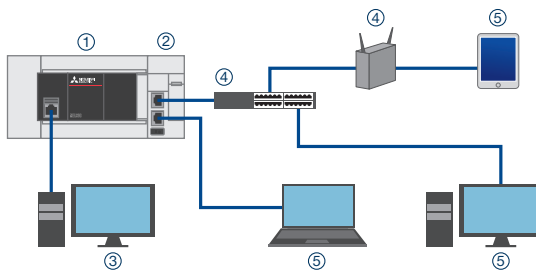

- ① FX5U CPU module/FX5UC module
- ② FX5-OPC (OPC UA server)
- ③ Personal computer in which GX Works3 or OPC UA Module Configuration Tool is installed
- ④ Ethernet switch/router (optional)
- ⑤ OPC UA client

The number of labor-hours for development can be reduced via the special setting tool.

For a setting of FX5-OPC module parameters and address space parameters, GX Works3*2 is used.

For a setting of IP addresses and security parameters, control for server certificates, OPC UA Module Configuration Tool*3 is used.

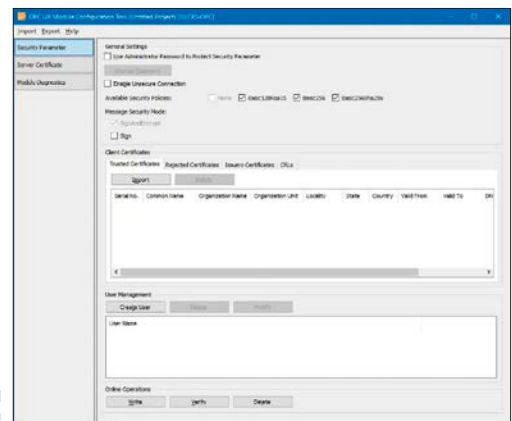

OPC UA Module Configuration Tool Security parameter settings screen

*1: Connection with FX5UC CPU module requires connector conversion module (FX5-CNV-IFC) or extension power supply module (FX5-C1PS-5V). Supported by the FX5U/FX5UC CPU module Ver. 1.245 or later.
 *2: Supported by the GX Works3 Ver.1.077F or later.
 *3: Supported by the OPC UA Module Configuration Tool Ver. 1.00A or later.

Station type list

Applicable station types vary depending on used modules and devices.

✓: Supported, ×: Not supported

Type	Used module/device (Model name)	Station type		Applicable CPU module		
		Master	Slave	FX5UJ	FX5U	FX5UC
CC-Link IE TSN	FX5-CCLGN-MS	✓	✓	×	✓	✓*1
	FX5-40SSC-G	✓	×	×	✓	✓*1
	FX5-80SSC-G	✓	×	×	✓	✓*1
CC-Link IE Field Network	FX5-CCLIEF	×	✓	✓	✓	✓*1
CC-Link IE Field Network Basic	FX5UJ/FX5U/FX5UC CPU module (Built-in Ethernet port)	✓	×	✓	✓	✓
	FX5-ENET	✓	×	✓	✓	✓*1
CC-Link V2	FX5-CCL-MS	✓	✓	✓	✓	✓*1
	FX3U-16CCL-M	✓	×	×	✓*2	✓*2
	FX3U-64CCL	×	✓	×	✓*2	✓*2
PROFIBUS-DP	FX5-DP-M	✓	×	✓	✓	✓*1
	FX3U-32DP	×	✓	×	✓*2	✓*2
MODBUS/RTU	FX5U/FX5UC CPU module (Built-in RS-485 port)	✓	✓	×	✓	✓
	FX5-232ADP	✓	✓	✓	✓	✓
	FX5-485ADP	✓	✓	✓	✓	✓
	FX5-232-BD	✓	✓	✓	✓	×
FX5-485-BD	✓	✓	✓	✓	×	
MODBUS/TCP	FX5UJ/FX5U/FX5UC CPU module (Built-in Ethernet port)	✓	✓	✓	✓	✓

Type	Used module/device (Model name)	Station type		Applicable CPU module			
		Server	Client	FX5UJ	FX5U	FX5UC	
SLMP	3E frame	FX5UJ/FX5U/FX5UC CPU module (Built-in Ethernet port)	✓	✓	✓	✓	
		FX5-ENET, FX5-ENET/IP	✓	×	✓	✓	✓*1
	1E frame	FX5UJ/FX5U/FX5UC CPU module (Built-in Ethernet port)	✓	×	✓	✓	✓
		FX5-ENET, FX5-ENET/IP	✓	×	✓	✓	✓*1
EtherNet/IP	Class3 message communications	✓	×	✓	✓	✓*1	
	UCMM message communications	FX5-ENET/IP	✓	✓	✓	✓	✓*1
BACnet	FX5-ENET	✓	×	✓	✓	✓*1	
	FX5-ENET/IP	✓	×	✓	✓	✓*1	
OPC UA	FX5-OPC	✓	×	×	✓	✓*1	

Type	Used module/device (Model name)	Station type		Applicable CPU module		
		Scanner	Adapter	FX5UJ	FX5U	FX5UC
EtherNet/IP	Class1 instance communications (Cyclic communication)	FX5-ENET/IP	✓	✓	✓	✓

*1: Connection with FX5UC CPU module requires connector conversion module (FX5-CNV-IFC) or extension power supply module (FX5-C1PS-5V).

*2: Connection with FX5U/FX5UC CPU module requires FX5-CNV-BUS or FX5-CNV-BUSC.



Programming Environment GX Works3

GX Works3 is software that comprehensively supports the design and maintenance of sequence programs. Graphical intuitive operability, and easy programming by just “selecting”. A diagnostic function that has a troubleshoot function realizes the reduction of engineering cost.

System design with a convenient parts library

With GX Works3, designing a system is as easy as preparing the module configuration diagram by dragging and dropping selected parts.

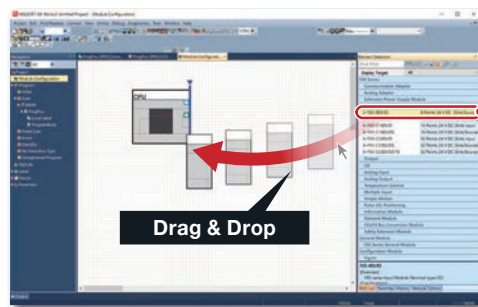

Simply drag & drop when adding a module

Auto-generation of module parameters

When preparing the module configuration diagram, simply double-click the module to automatically generate the module parameters. A window with an easy-to-use parameter settings screen opens, enabling module parameters to be modified as needed.

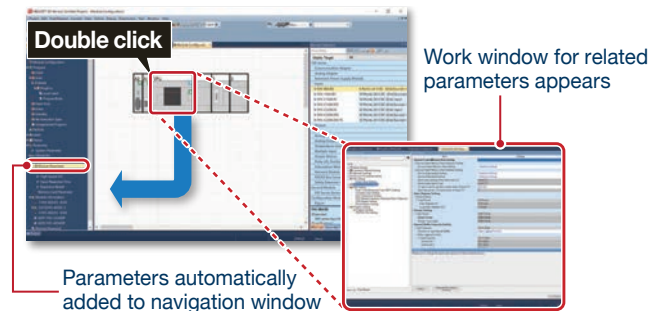

Simple setting of module parameters GX Works3: Ver. 1.060N or later

Various parameters can be set easily. Even high-speed counters with many parameters can be set without a manual by simply following the wizard. You can also easily check the high-speed counter CH used and the location of wiring.

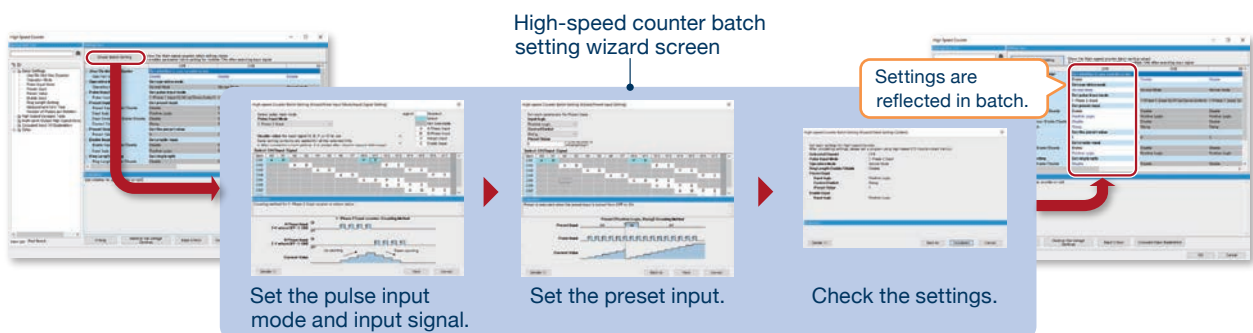



Ladder language edition



FBD/LD language edition

YouTube
MITSUBISHI ELECTRIC Factory Automation
MELSEC IQ-F Series Quick Start Guide



You can see the basics of programming using GX Works3 from the catalog on the left or reading the QR code. L(NA)08449ENG

Reduce repetitive program tasks

With GX Works3, global labels, local labels, and module labels can be used as well as programming by devices. Global labels can be shared between multiple programs or between other MELSOFT software. Local labels can be used in registered programs and FBs. Module labels have buffer memory information of various intelligent function modules. Therefore, programming can be done without being conscious of the buffer memory address.

Global Label Editor

Local Label Editor

Module Label

Drag & Drop

The use of a structure can further reduce the number of labor-hours for programming.

A structure can integrate the variables of a specific basic data type as members into one. Each member (label) can be defined even when the data types are different. The number of labor-hours for programming can be reduced by using a created structure.

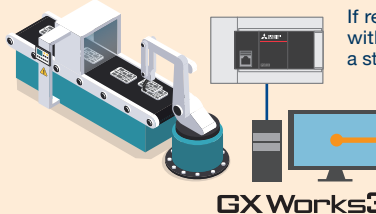

If relevant information is collected within the program and integrated into a structure...

Structures	
Member	Switch 1
Member	Switch 2
Member	Switch 3

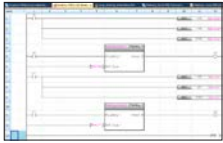

A previously made structure can be used.

The structure can be used for another purpose within the program.

It can be used for the programs of other equipment.

A structure can be used to access a device with the label name regardless of the device address.

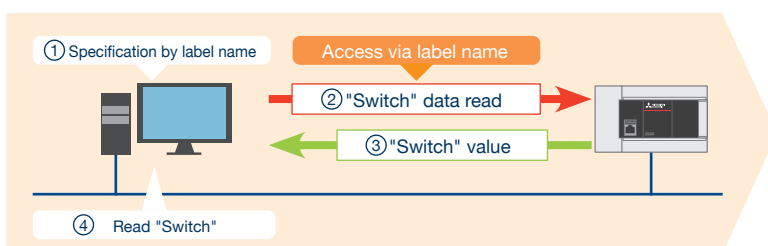

Programs made by someone can be easily understood by using labels. Readout is possible by using a label name.

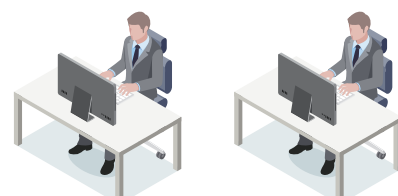

Function Introduction



Programming Environment

Simple and convenient parameter settings

With MELSEC iQ-F series, various device settings that conventionally had to be programmed can be input in table format.

Easily set the built-in functions as well as extension devices just by inputting values into the parameters.

The program's execution trigger can also be set with the parameters.

Functions which can be set with parameters

- CPU parameter • Ethernet port • RS-485 port
- Input response time • Expansion board • Memory card • Security
- Expansion adapter and intelligent function module
- Program parameters

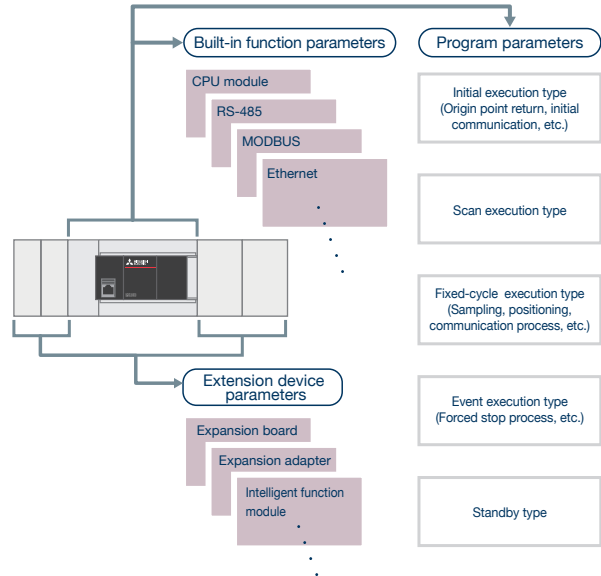

Flexible internal devices

A variety of devices including new latch relays and link relays, and expanded timers and counters are available.

In the FX5U/FX5UC CPU module, the assignment of device points in the internal memory can be changed and used.

Providing the convenience of special devices

In addition to the conventional special devices, up to 12000 points of convenient system devices compatible with upper level devices are added.

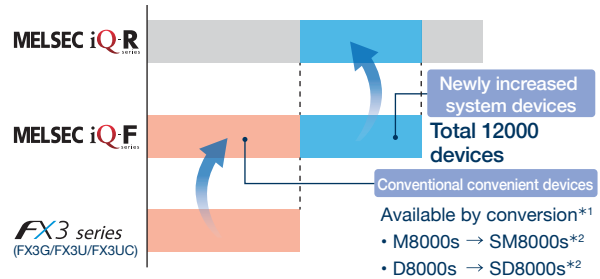

Freely customize the latch range setting

In the FX5U/FX5UC CPU module, the latch range can be set for each device.

The clear object can be selected when the CPU memory is operated.

Item	Symbol	Device		Latch (1)	Latch (2)
		Points	Range		
Input	X	0	0 to 1777		
Output	Y	1024	0 to 1777		
Internal Relay	M	7680	0 to 7679	500 to 7679	No Setting
Link Relay	B	256	0 to FF	No Setting	No Setting
Link Special Relay	SB	512	0 to 1FF		
Annunciator	F	128	0 to 127	No Setting	No Setting
Step Relay	S	4096	0 to 4095	500 to 4095	
Timer	T	512	0 to 511	No Setting	No Setting
Retentive Timer	ST	16	0 to 15	0 to 15	No Setting
Counter	C	256	0 to 255	100 to 199	No Setting
Long Counter	LC	64	0 to 63	20 to 63	No Setting
Data Register	D	8000	0 to 7999	200 to 7999	No Setting
Latch Relay	L	7680	0 to 7679		
Area Capacity			12.8K Word		11.8K Word
Total Device			11.2K Word		9.8K Word
Total Word Device			10.2K Word		8.1K Word
Total Bit Device			15.9K Bit		25.1K Bit

Handy timer and counter settings

The timer and counter properties are determined by data type and how instruction is written, so programs can be created regardless of the device number.

Timers	
OUT T0	100 ms timer
OUTH T0	10 ms timer
OUTH S T0	1 ms timer

Counters	
OUT C0	16 bits counter
OUT LC0	32 bits counter

Retentive timers	
OUT ST0	100 ms retentive timer
OUTH ST0	10 ms retentive timer
OUTH S ST0	1 ms retentive timer

*1: When projects for the FX3G/FX3U/FX3UC created using GX Works2 are diverted for the MELSEC iQ-F series, devices are automatically converted.
*2: Some device names and device numbers may differ.

Driving simulation

With GX Simulator3, programs can be debugged with a virtual PLC on the computer. It is convenient to be able to check before operating on the real machine.

CPU module simulation

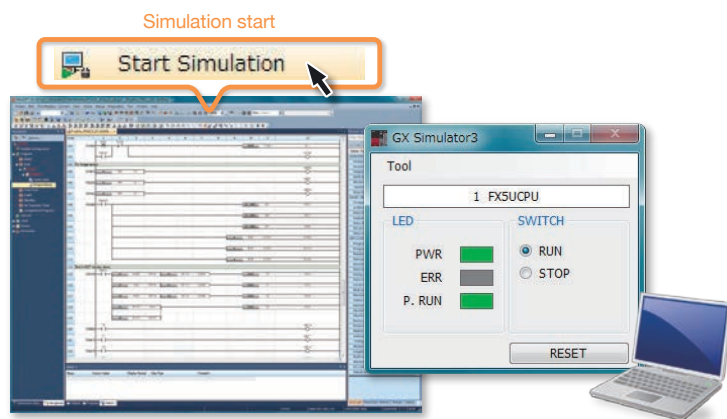

Even without a real machine,
the cooperation of
CPU module
+ simple motion
can be verified!

Simple motion simulation*

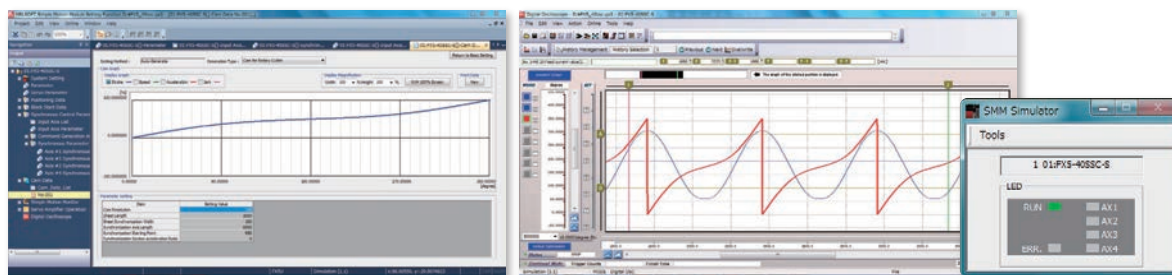

It is possible to check the operation even if there is no real machine. Simulation can be done without going to the site, which leads to a reduction in man-hours for programming.

Even without a servo motor or amplifier, it is possible to check operation closer to actual machine tests.

Integrated simple motion setup tool

GX Works3 is equipped with a simple motion setup tool that makes it easy to change simple motion module settings such as module parameters, positioning data and servo parameters. Also, the servo adjustment is simplified using it.

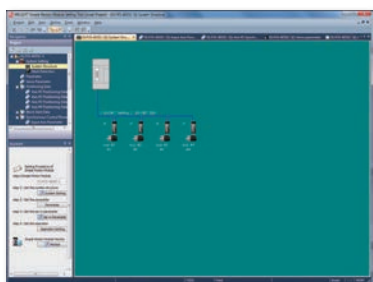

System Configuration

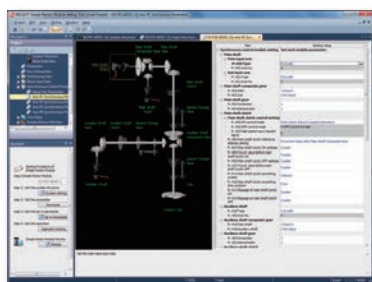

Synchronized Control Parameter

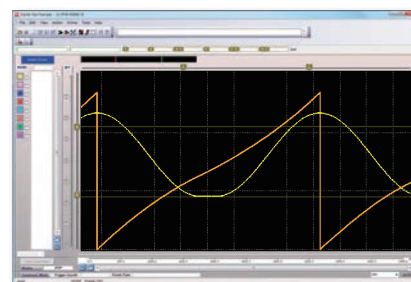

Digital Oscilloscope

*: Supported by GX Works3 Ver. 1.035M or later.

Function Introduction



Programming Environment

Dramatically more dedicated instructions

Compared with the FX3 series, a significant number of dedicated instructions have been added.

[FX3 series] 510 dedicated instructions → [MELSEC iQ-F series] Expanded to 1164 dedicated instructions*1

The newly added instructions include convenient ones that are interchangeable with the MELSEC iQ-R and dedicated instructions for built-in functions. (Only FX3G, FX3GC, FX3U, and FX3UC programs can be imported)

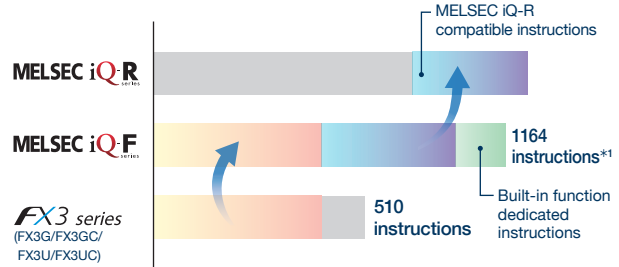

Intuitive and easy-to-understand arithmetic operations

Symbols can be input in the arithmetic operations making it easy and intuitive to describe programs.

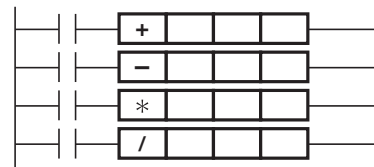

High-performance built-in high-speed counter function

Parameter setting enables input/measurement in three modes. By using the module parameter's high-speed counter batch setting*2, even high-speed counters having many parameters can be set simply without manual operations but just by following the wizard. Furthermore, it is possible to set 32 high-speed comparison tables*3 and 128 multi-point output high-speed comparison tables. In addition, the DHCMOV instruction can read the latest value to the special register.

- Normal mode
- Pulse density measurement mode
- Rotation speed measurement mode

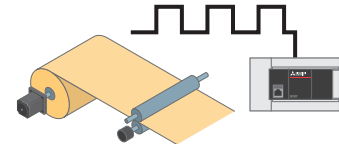

Reinforced built-in positioning function

Positioning can be easily performed with table operation instructions. Even advanced positioning like simple linear interpolation is possible with the multi-table operation (DRVTLB) instruction and multi-axis table operation (DRVMUL) instruction.

Diverse table operation settings for multi-speed and interrupt positioning, etc.

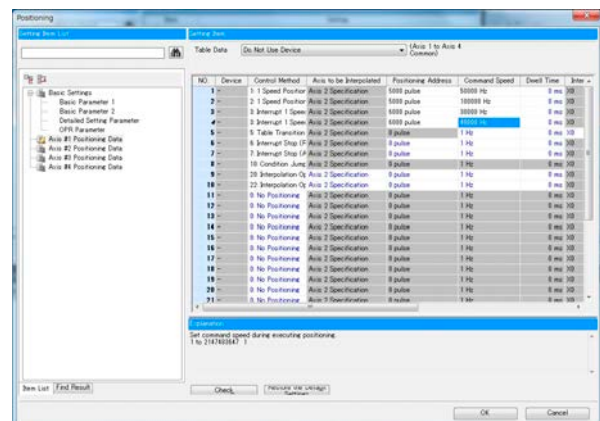

*1: When using FX5U/FX5UC CPU module Ver. 1.240.
 *2: Supported by GX Works3 Ver. 1.060N or later.
 *3: Supported by FX5U/FX5UC CPU module Ver. 1.040 or later and product number 158**** or later.

Offline monitor (logging) function GX Works3: Ver. 1.040S or later

The device values in the logging file shown on the GX LogViewer can be displayed in the program editor of GX Works3. When logging files are available, it is possible to reproduce and check the device status offline from a place far from the site by linking* the timeline (red cursor) on GX LogViewer with the slider on the seek bar on GX Works3. Data is displayed as a waveform graph, and changes can be seen at a glance. Equipment abnormalities can be visualized.

GX Works3 and GX LogViewer work together for debugging without a PLC!

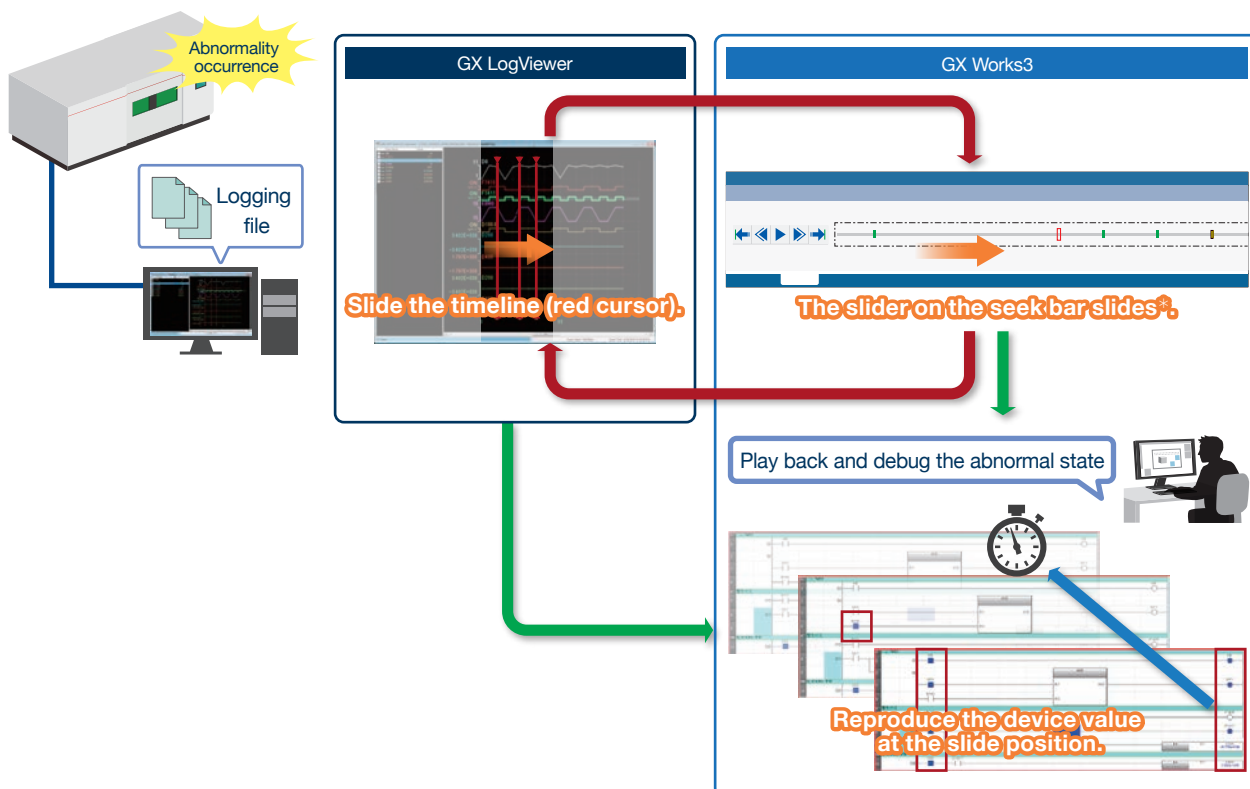

*: The link between the seek bar display and GX LogViewer is supported by GX Works3 Ver. 1.065T or later.

Function Introduction



Programming Environment



For details, refer to the guide on the right.
L(NA)08475ENG

MELSOFT Library useful for reducing man-hours

What is FB?

FB stands for "function block", and indicates a sequence program made into a circuit block part used repeatedly.

GX Works3



These are great advantages of FB!

High reusability!

When diverting an existing sequence program, revision is needed to prevent device duplication.

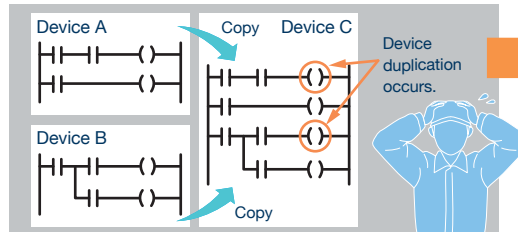

In program (processing) management, programs can be easily diverted by dragging & dropping FBs.

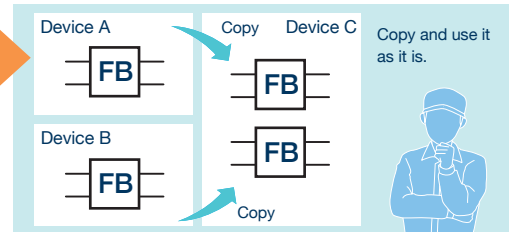

Easy to read!

In an existing sequence program, all programs are displayed and appearance is complicated.

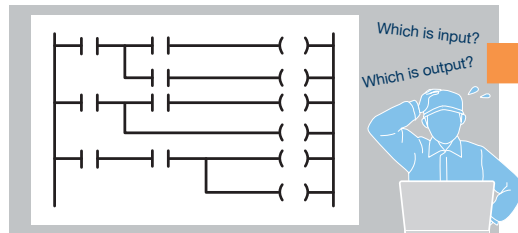

In FB, only necessary input/output are displayed and appearance is simple.

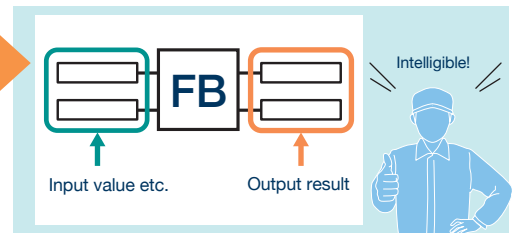

Module FBs to control each module are prepared.

"Module FB" is a componentized program that controls each module.

Using the module FBs eliminates the need for programming the processing of each module and reduces programming man-hours.

Module FBs are included in GX Works3 in advance.

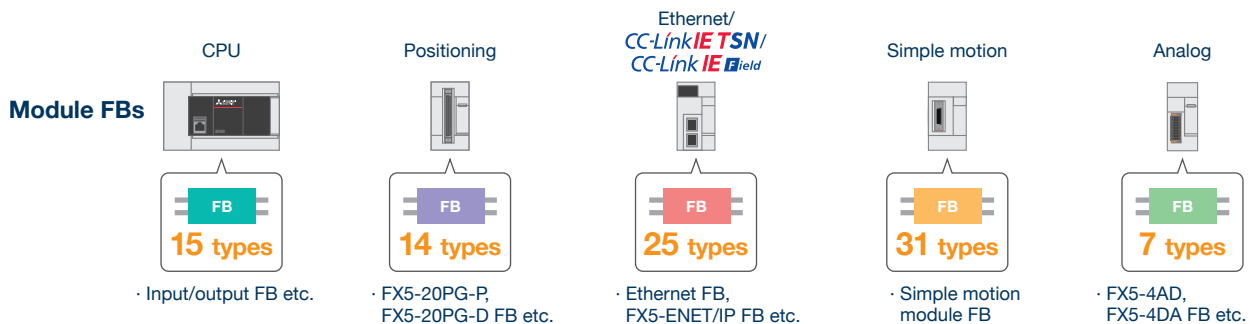

For the types of FBs, refer to page 179.



Actuator setting is easy with the positioning communication protocol support function.

For details about the positioning communication protocol support function, see the leaflet shown at right. L(NA)08787ENG

The “positioning communication protocol support tool” is available for easy connection with an electric actuator. The use of the “positioning communication protocol support FB” can reduce the number of labor-hours required for programming.

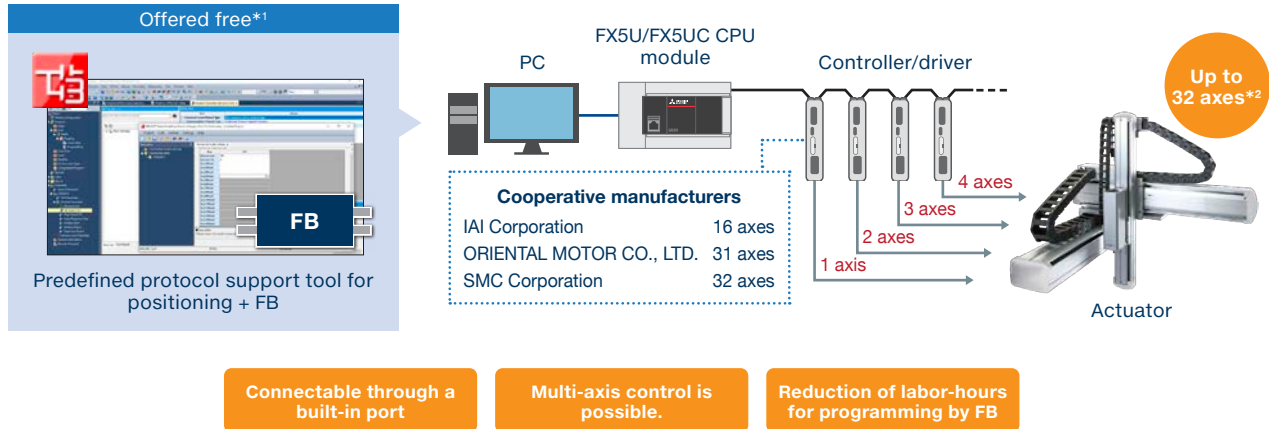

● Example of application: Drink filling machines

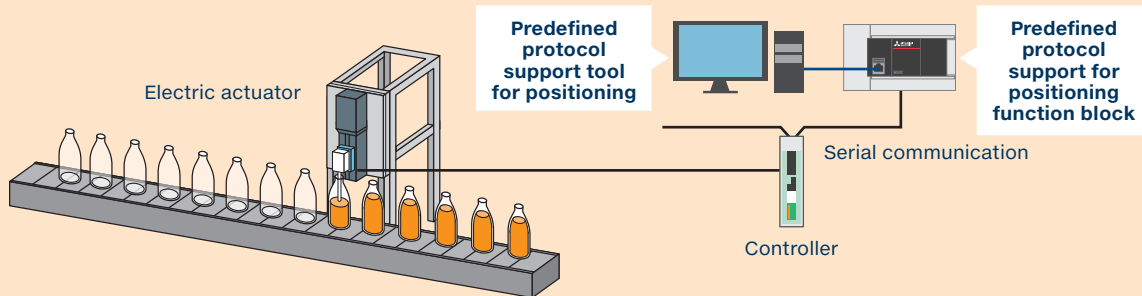

Setting by selecting a model for each axis

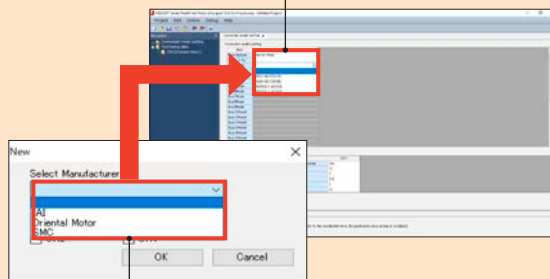

A communication protocol can be set only by selecting the model connected by each manufacturer.

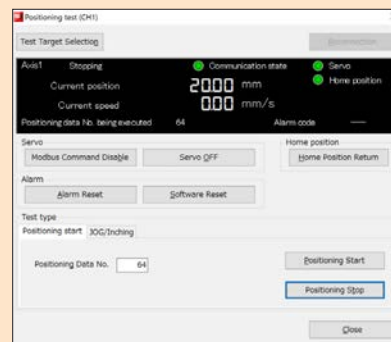

You can adjust the positioning operation while monitoring the operation of the electric actuator.

*1: Please contact your local Mitsubishi Electric sales office or representative.
*2: In the case of SMC Corporation

Function Introduction

Programming Environment

A recording system can be realized by FB linked with a camera. NEW

When a machine trouble occurs, the cause cannot be identified by visiting the site. The recording system can be realized by using the FB linked with a camera for the network camera connected to the Ethernet port. The cause of machine troubles can be identified easily.

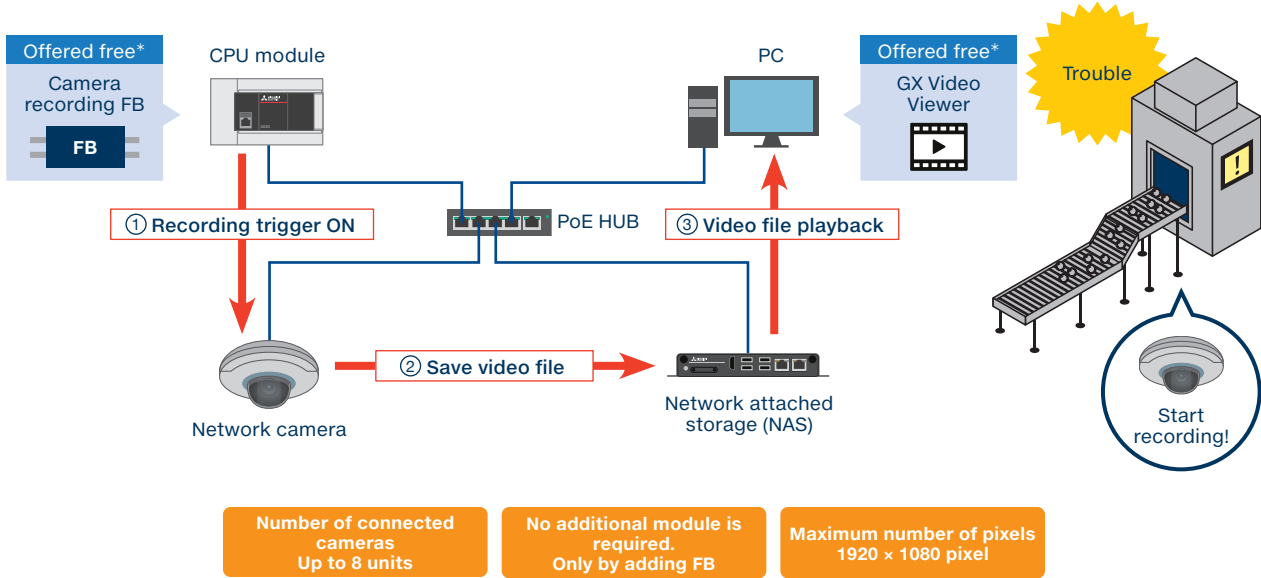

● Example of application: Work transfer equipment with suction mechanism

*: Please contact your local Mitsubishi Electric sales office or representative.



For details of e-F@actory Starter Package, refer to the leaflet on the right. E001ENG

e-F@actory Starter Package

The e-F@actory Starter Package is an example of a project that enables easy analysis of equipment information integrated in the programmable controller, and displays the analysis result on the GOT.

1. Offered free*-of-charge as sample projects that can be introduced easily.



2. Offers many functions for data collection, visualization, simple analysis, etc. on the production site level.
3. Can be introduced easily only by device assignment and parameter setting.



IoT can be utilized on production sites!

[Easy introduction of IoT by "Visualization × Diagnosis"!] Equipment total efficiency monitor

Visualization of the defective product occurrence ratio and equipment stop ratio visualizes and improves problems. It is possible to shift from the equipment total efficiency monitor screen to each function screen. Alarm occurrence positions can be checked, and the detailed situation can be checked on each function screen.

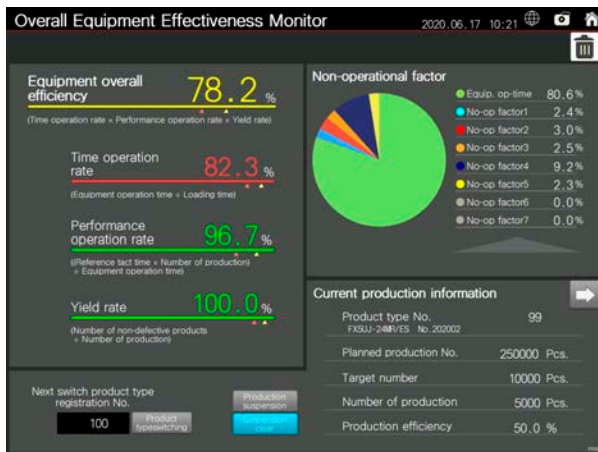

[Simple analysis by "Data collection × Visualization"!] Cylinder & cycle time measurement monitor

It is possible to visualize the alarm occurrence status, and whether or not the operation time exceeds the threshold value. The maintenance timing can be grasped before the production efficiency decreases, and preventive maintenance is enabled.

No.	Status	Name	Measured value [ms]	Max. value	1-level min.	Master time	1-level max.	Accumulated time [sec]	Accumulated count [times]
1	Alarm	Cylinder 01	5452	5452	4500	5000	5500	1247	238
1	Normal	Cylinder 02	5246	5451	4500	5000	5500	1244	252
3	Normal	Cylinder 03	5432	5416	4000	5000	5500	1178	238
4	Normal	Cylinder 04	5364	5446	4000	5000	5500	1247	238
5	Normal	Cylinder 05	4828	5446	4500	5000	5500	1244	252

[Predictive maintenance by MELSEC iQ-F] MT method

The MT method is a multivariate analysis technique to which the Mahalanobis distance used in statistical analysis is applied. For example, by monitoring the temperature and vibration of the crimping device using the MT method, an "unusual state" can be detected and unexpected failures can be prevented beforehand. In addition, the defect occurrence trend is detected, and prevention of defect occurrence is supported.

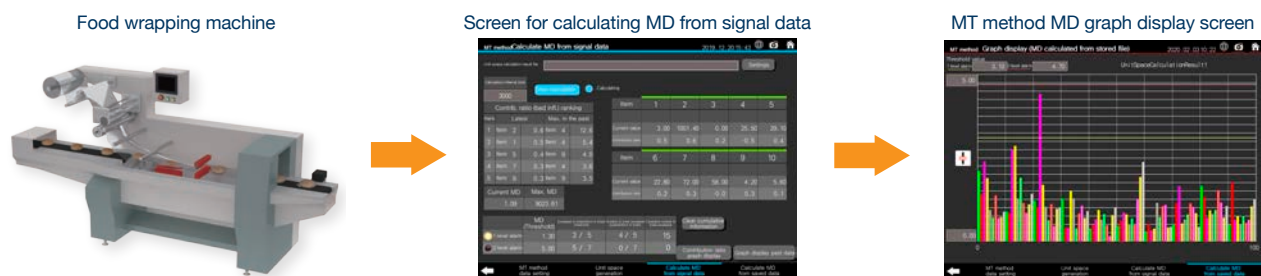

Food wrapping machine

Screen for calculating MD from signal data

MT method MD graph display screen

The deviation state (Mahalanobis distance) is calculated from normal data.

Calculated results can be displayed in a graph. Defect trends can be visualized.

*: Please contact your local Mitsubishi Electric sales office or representative.

Function Introduction

Programming Environment

Project version management function GX Works3: Ver. 1.057K or later

The project version management function manages the revision history of a project by recording changes in the project. Programs created by multiple developers can be merged into one project or restored to a past state for each data, so programming human-hours can be reduced.

**With
GX Works3 alone,
the configuration
can be managed!**

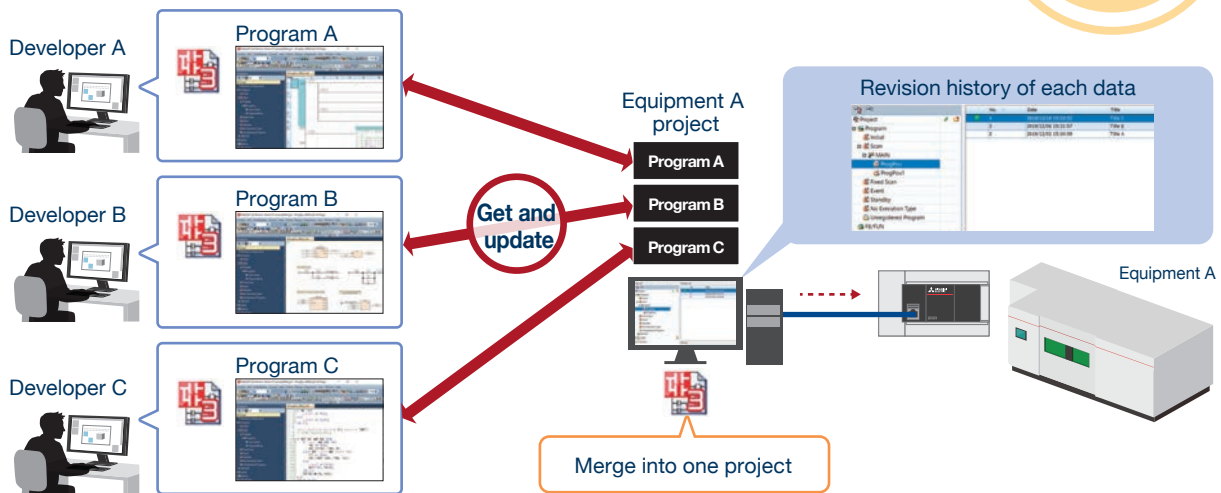

Data flow analysis function GX Works3: Ver. 1.065T or later

It is troublesome to sequentially check complicated devices/labels one by one when an error occurs. The data flow analysis function can display only devices/labels that affect the analysis target device/label in the flow chart, and facilitates factor analysis at error occurrence. The function can also be used to monitor the devices/labels displayed in the flow chart to check for changes in the current values.

Data flow analysis display screen

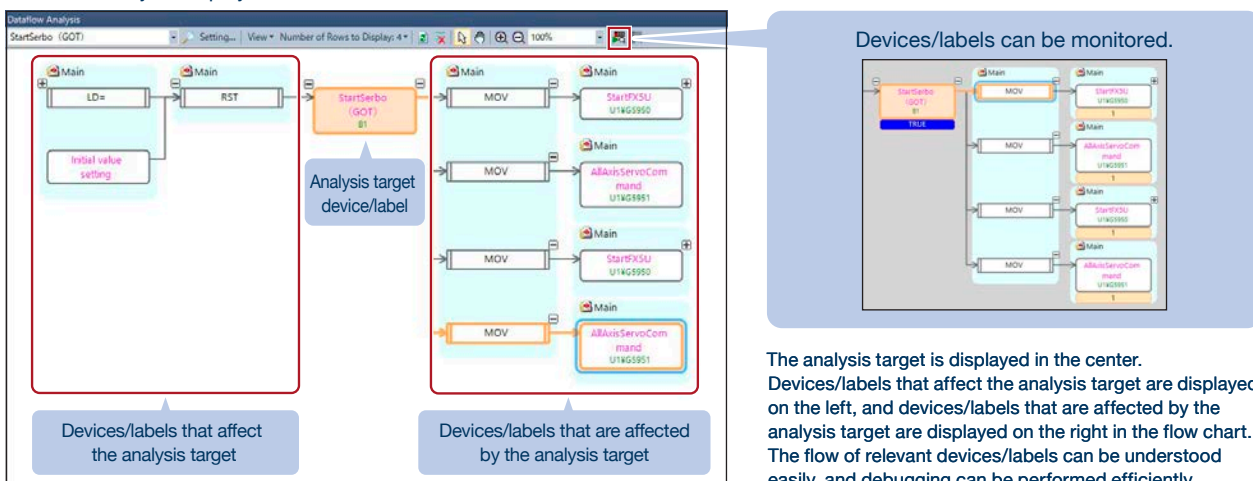

The analysis target is displayed in the center. Devices/labels that affect the analysis target are displayed on the left, and devices/labels that are affected by the analysis target are displayed on the right in the flow chart. The flow of relevant devices/labels can be understood easily, and debugging can be performed efficiently.



Programming Software

MELSOFT iQ Works

MELSOFT iQ Works is based on the system control software MELSOFT Navigator, and includes each engineering software. (GX Works2/GX Works3, MT Works2, GT Works3, RT ToolBox3 mini, FR Configurator2)



MELSOFT iQ Works FA Integrated Engineering Software*1

iQ Works (English version) Model: SW2DND-IQWK-E (DVD-ROM)

MELSOFT GX Works3 PLC Engineering Software*1

GX Works3 (English version) Model: SW1DND-GXW3-E (DVD-ROM)

◇ Corresponding models

GX Works3 software **FX5UJ, FX5U, FX5UC**

GX Works2 software*2 **FX3U, FX3UC, FX3G, FX3GE, FX3GC, FX3S**

Programs created with GX Works2 can be used with GX Works3.

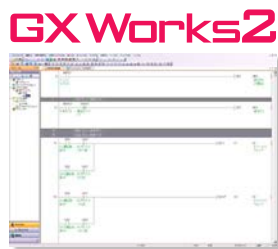

Reading

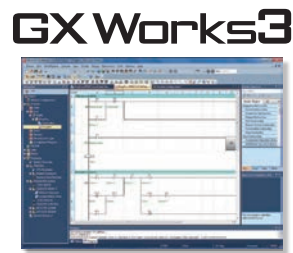

A special catalog (separate booklet) of MELSOFT iQ Works is available.
(Functions shown in the catalog vary according to PLC model.)

For details, refer to the following catalog:
"MELSOFT iQ Works catalog" L(NA)08232ENG



*1: GX Works2 is also enclosed.

*2: For the models compatible with each software, refer to the manual for each product.

Function compatibility table

■Function compatibility table

Function		Supported CPU module firmware version		Supported engineering tool software version	
		FX5UJ	FX5U/FX5UC	FX5UJ	FX5U/FX5UC
SLMP communications	3E frame	From the first	From the first	GX Works3: 1.060N or later	From the first
	1E frame	Not supported	"1.210" or later	—	—
CC-Link IE Field Network Basic		From the first	"1.040" or later	GX Works3: 1.060N or later	GX Works3: 1.030G or later
Data logging function		From the first	"1.040" or later Serial number 16Y**** or later	GX Works3: 1.060N or later (CPU module logging setting tool: 1.100E or later) (GX LogViewer: Ver. 1.100E or later)	GX Works3: 1.030G or later (CPU module logging setting tool: 1.64S or later) (GX LogViewer: Ver. 1.64S or later)
			Compatibility with CSV file format	Not supported	"1.210" or later Product number 17X**** or later*1
IP filter function		From the first	"1.050" or later	GX Works3: 1.060N or later	GX Works3: 1.035M or later
Parallel link function			"1.050" or later		GX Works3: 1.035M or later
File transfer function			FTP server		"1.040" or later Product number 16Y**** or later
File transfer function	FTP client	Not supported	Sending file	—	GX Works3: 1.065T or later
			Getting file		"1.240" or later Serial number 17X**** or later*1
Backup/restore function		Not supported	Device/label data	—	—
			Data memory		"1.045" or later Product number 16Y**** or later
Memory dump function		From the first	"1.050" or later Serial number 16Y**** or later	GX Works3: 1.060N or later	GX Works3: 1.035M or later
Real-time monitoring function			"1.060" or later	GX Works3: 1.060N or later (GX LogViewer: Ver. 1.100E or later)	GX Works3: 1.040S or later (GX LogViewer: Ver. 1.76E or later)
Web server function	System Web page	Not supported	"1.060" or later	GX Works3: 1.060N or later	GX Works3: 1.040S or later
	User Web page		"1.100" or later Serial number 17X**** or later*1		—
Simple CPU communication function		From the first	"1.110" or later Product number 17X**** or later*1	GX Works3: 1.060N or later	GX Works3: 1.050C or later
			Communication counterpart device*2 addition		Not supported
MODBUS/TCP communication function		From the first	"1.060" or later	GX Works3: 1.060N or later	GX Works3: 1.040S or later
Time setting function (SNTP client)			"1.060" or later		GX Works3: 1.060N or later

*1: Supported by serial number 178**** for FX5UC-32MT/DS-TS and FX5UC-32MT/DSS-TS or later.
 *2: For details of the corresponding communication counterpart device, refer to the manual.

memo

FUTURE MANUFACTURING

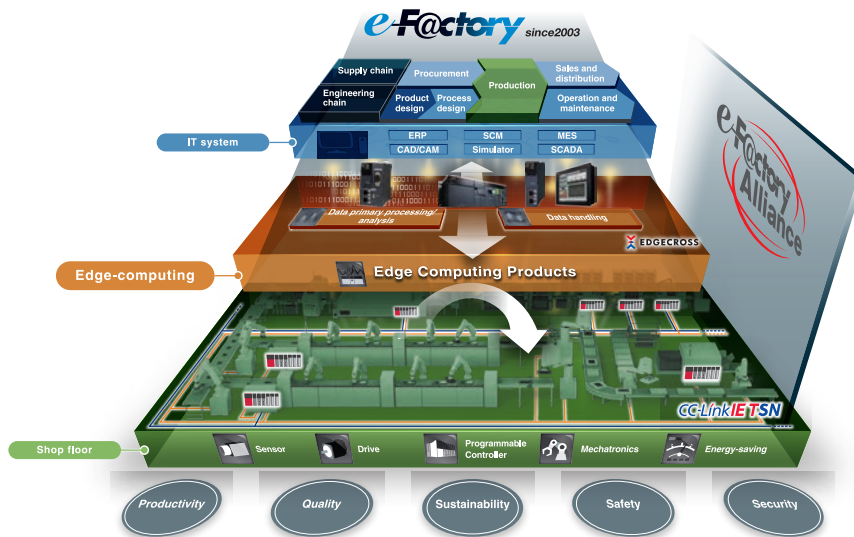

The Future of Manufacturing as envisioned by Mitsubishi Electric, e-F@ctory: “Manufacturing” that evolves in response to environmental changes in an IoT enabled world.

Established In 2003, e-F@ctory created a Kaizen^{#1} automation methodology to help optimize and manage the increasingly complex business of “manufacturing”. Continuously evolving itself, it also utilizes the expanded reach of IT, which has brought “cyber world” benefits of analysis, simulation and virtual engineering, and yet has also placed greater demands on the “physical” world for increased data sensing, collection and communication. The continued success of e-F@ctory comes from understanding that each manufacturer has individual needs and investment plans but must still deliver; “Reduced management costs” (TCO); production flexibility to make a multitude of product in varying quantities; continuously enhanced quality. In short e-F@ctory’s goal is to deliver operational performance that is “a step ahead of the times”, while enabling manufacturing to evolve in

response to its environment. To do this it is supported by three key elements:

- The e-F@ctory Alliance Partners; who bring a wide range of software, devices, and system integration skills that enable the creation of the optimal e-F@ctory architecture.
- Advanced communication; utilizing open network technology like CC-Link IE, and communication middleware such as OPC, to open the door to device data, including legacy systems, while supporting high speed extraction.
- Platform thinking; to reduce the number of complex interfaces making it easier to bring together Robotics, Motion, Open programming languages (C language), PACs etc. strengthening the field of control,

yet operating on industrial strength hardware.



Table of Contents

Lineup Details/Model Selection	66	1
Safety Control	87	2
I/O Module	91	3
Analog Control	101	4
High-Speed Counter	115	5
Pulse Output/Positioning	121	6
Network/Communication/Information-sharing	133	7
Programming/Development Environment	167	8
Option/Related Products	171	9
Related information	179	10
Overseas Service System/Compatible Products	181	11
Specifications	185	12
Products List	245	13

Selecting the FX5UJ model

◇ Product configuration



FX5UJ

- Control scale: 24 to 256 points (CPU module: 24/40/60 points)
- With as many built-in functions as the FX5U/FX5UC CPU module. Providing excellent cost performance.



* For details about the connection positions, refer to the manual.

Type	Details	Connection details, model selection
1 CPU module	PLC with built-in CPU, power supply, input/output and program memory.	Various extension devices can be connected.
2 4 I/O module (extension cable type)	Product for extending I/O of extension cable type. Some products are powered.	The maximum number of input and output points for the entire system is 256 points. Up to 8 extension modules can be connected. (Extension power supply modules and connector conversion modules are not included in the number of connected modules.) For details, refer to "Rules for System Configuration" on p. 70.
3 FX5 extension power supply module	Module for extending power supply if CPU module's internal power supply is insufficient. Extension cable is enclosed.	Power can be supplied to I/O module, intelligent function module. Up to 1 module can be connected.
5 FX5 intelligent function module	Module with functions other than input/output.	Up to 8 extension modules including the I/O module can be connected (Extension power supply modules and connector conversion modules are not included in the number of connected modules.)
6 Connector conversion module	Module for connecting FX5 Series (extension connector type) extension module.	An extension module (extension connector type) for FX5 can be connected.
7 I/O module (Extension connector type)	Product for adding extension connector type inputs/outputs.	The maximum number of input and output points for the entire system is 256 points. Up to 8 extension modules can be connected. (Extension power supply modules and connector conversion modules are not included in the number of connected modules.) Using this type of I/O module requires the connector conversion module.
8 FX5 expansion board	Board connected to front of CPU module to expand functions.	Up to 1 module can be connected to the front of the CPU module. (Expansion adapter can also be used.)
9 FX5 expansion adapter	Adapter connected to left side of CPU module to expand functions.	Up to 2 communication adapters and up to 2 analog adapters (up to 4 adapters in total) can be connected on the left side of the CPU module. When 8 is used, the number is limited.
10 FX5 safety extension module	Module for configuring a safety control system.	Up to 1 safety main module and up to 2 safety input extension modules can be connected. Extension modules cannot be connected on the subsequent stage (the right side) of the safety extension module.

1 CPU module (AC power supply, DC input type)

Model	Function	Number of occupied input/output points	Power supply capacity	I/O type	No. of input points	No. of output points
			24 V DC service power supply			
FX5UJ-24MR/ES	CPU module (24 V DC service power built-in)	24 points (32 points)*1	400 mA (460 mA*2)	DC input (sink/source)/relay output	14 points (16 points)*1	10 points (16 points)*1
FX5UJ-24MT/ES				DC input (sink/source)/transistor (sink)		
FX5UJ-24MT/ESS				DC input (sink/source)/transistor (source)		
FX5UJ-40MR/ES		40 points	400 mA (500 mA*2)	DC input (sink/source)/relay output	24 points	16 points
FX5UJ-40MT/ES				DC input (sink/source)/transistor (sink)		
FX5UJ-40MT/ESS				DC input (sink/source)/transistor (source)		
FX5UJ-60MR/ES		60 points (64 points)*1	400 mA (550 mA*2)	DC input (sink/source)/relay output	36 points (40 points)*1	24 points
FX5UJ-60MT/ES				DC input (sink/source)/transistor (sink)		
FX5UJ-60MT/ESS				DC input (sink/source)/transistor (source)		

*1: The number in parentheses represents occupied points. Use the value in parentheses to calculate the total number of input/output points.

*2: Power supply capacity when an external power supply is used for input circuits.

2 I/O module (AC power supply/DC input type) (extension cable type)

Model	Function	Number of occupied input/output points	Power supply capacity		I/O type	No. of input points	No. of output points
			5 V DC power supply	24 V DC service power supply			
FX5-32ER/ES	I/O module (24 V DC service power built-in)	32 points	965 mA	250 mA (310 mA*)	DC input (sink/source)/relay output	16 points	16 points
FX5-32ET/ES					DC input (sink/source)/transistor (sink)		
FX5-32ET/ESS					DC input (sink/source)/transistor (source)		

*: Power supply capacity when an external power supply is used for input circuits.

3 FX5 extension power supply module

Model	Function	Number of occupied input/output points	Power supply capacity	
			5 V DC power supply	24 V DC power supply
FX5-1PSU-5V	Extension power supply	—	1200 mA*	300 mA*

*: Derating occurs when the ambient temperature exceeds 40°C. For details, refer to the manual.

4 I/O module (extension cable type)

Model	I/O type	Number of occupied input/output points	Current consumption	
			5 V DC power supply	24 V DC power supply
FX5-8EX/ES	DC input (sink/source)	8 points	75 mA	50 mA (0 mA*)
FX5-16EX/ES	DC input (sink/source)	16 points	100 mA	85 mA (0 mA*)
FX5-8EYR/ES	Relay output	8 points	75 mA	75 mA
FX5-8EYT/ES	Transistor output (sink)			
FX5-8EYT/ESS	Transistor output (source)			
FX5-16EYR/ES	Relay output	16 points	100 mA	125 mA
FX5-16EYT/ES	Transistor output (sink)			
FX5-16EYT/ESS	Transistor output (source)			
FX5-16ER/ES	DC input (sink/source)/relay output	16 points	100 mA	125 mA (85 mA*)
FX5-16ET/ES	DC input (sink/source)/transistor output (sink)			
FX5-16ET/ESS	DC input (sink/source)/transistor output (source)			

*: Current consumption when an external power supply is used for input circuits.

5 FX5 intelligent function module

Model	Function	Number of occupied input/output points	Current consumption		
			5 V DC power supply	24 V DC power supply	24 V DC external power supply
FX5-4AD	4-ch voltage/current input	8 points	100 mA	40 mA	—
FX5-4DA	4-ch voltage/current output	8 points	100 mA	—	150 mA
FX5-8AD	8-ch voltage/current/thermocouple/resistance temperature detector input	8 points	—	40 mA	100 mA
FX5-4LC	4-ch temperature control (resistance temperature detector/thermocouple/micro voltage)	8 points	140 mA	—	25 mA
FX5-20PG-P	Pulse output for 2-axis control (transistor output)	8 points	—	—	120 mA
FX5-20PG-D	Pulse output for 2-axis control (differential driver output)	8 points	—	—	165 mA
FX5-40SSC-S	Simple motion 4-axis control (SSCNET III/H compatible)	8 points	—	—	250 mA
FX5-80SSC-S	Simple motion 8-axis control (SSCNET III/H compatible)	8 points	—	—	250 mA
FX5-ENET	Ethernet communication	8 points	—	110 mA	—
FX5-ENET/IP	EtherNet/IP communication, Ethernet communication	8 points	—	110 mA	—
FX5-CCL-MS	CC-Link system master/intelligent device station	8 points*1	—	—	100 mA
FX5-CCLIEF	CC-Link IE Field Network intelligent device station	8 points	10 mA	—	230 mA
FX5-ASL-M	AnyWireASLINK system master	8 points	200 mA	—	100 mA*2
FX5-DP-M	PROFIBUS-DP master	8 points	—	150 mA	—

*1: When using FX5-CCL-MS as a master station, the number of remote I/O points on the network increases.

*2: This value does not include the supply current to slave modules (Max. 2 A).

6 Connector conversion module

Model	Function	Number of occupied input/output points	Current consumption	
			5 V DC power supply	24 V DC power supply
FX5-CNV-IF	Connector conversion (FX5 (Extension cable type) → FX5 (Extension connector type))	—	—	—

7 I/O module (Extension connector type)

Model	I/O type	Number of occupied input/output points	Current consumption	
			5 V DC power supply	24 V DC power supply
FX5-C16EX/D	DC input (sink)	16 points	100 mA	65 mA (0 mA*)
FX5-C16EX/DS	DC input (sink/source)			
FX5-C32EX/D	DC input (sink)	32 points	120 mA	130 mA (0 mA*)
FX5-C32EX/DS	DC input (sink/source)			
FX5-C32EX/DS-TS				
FX5-C16EYT/D	Transistor output (sink)	16 points	100 mA	100 mA
FX5-C16EYT/DSS	Transistor output (source)			
FX5-C16EYR/D-TS	Relay output			
FX5-C32EYT/D	Transistor output (sink)	32 points	120 mA	200 mA
FX5-C32EYT/DSS	Transistor output (source)			
FX5-C32EYT/D-TS	Transistor output (sink)			
FX5-C32EYT/DSS-TS	Transistor output (source)			
FX5-C32ET/D	DC input (sink)/transistor output (sink)	32 points	120 mA	165 mA (100 mA*)
FX5-C32ET/DSS	DC input (sink/source)/transistor output (source)			
FX5-C32ET/DS-TS	DC input (sink/source)/transistor output (sink)			
FX5-C32ET/DSS-TS	DC input (sink/source)/transistor output (source)			

*: Current consumption when an external power supply is used for the input circuits.

8 FX5 expansion board

Model	Function	Number of occupied input/output points	Current consumption	
			5 V DC power supply*1	24 V DC power supply
FX5-232-BD	RS-232C communication	—	— (20 mA)	—
FX5-485-BD	RS-485 communication			
FX5-422-BD-GOT	RS-422 communication (for GOT connection)			

*1: Current consumption calculation is not required for the FX5UJ CPU module. Shown in parentheses are values stated in the specifications of each product.

*2: The current consumption will increase when the 5 V type GOT is connected.

9 FX5 expansion adapter

Model	Function	Number of occupied input/output points	Current consumption		
			5 V DC power supply*1	24 V DC power supply*1	24 V DC external power supply
FX5-232ADP	RS-232C communication	—	— (30 mA)	— (30 mA)	—
FX5-485ADP	RS-485 communication		— (20 mA)		
FX5-4A-ADP*2	2 ch voltage input/current input, 2 ch voltage output/current output		— (10 mA)	—	100 mA
FX5-4AD-ADP	4 ch voltage input/current input		— (10 mA)	— (20 mA)	160 mA
FX5-4AD-PT-ADP	4 ch temperature sensor (resistance temperature detector) input				
FX5-4AD-TC-ADP	4 ch temperature sensor (thermocouple) input				
FX5-4DA-ADP	4 ch voltage output/current output				

*1: Current consumption calculation is not required for the FX5UJ CPU module. Shown in parentheses are values stated in the specifications of each product.

*2: Supported by FX5UJ CPU modules Ver. 1.010 or later.

10 FX5 safety extension module

Model	Function	Number of occupied input/output points	Current consumption		
			5 V DC power supply	24 V DC power supply	24 V DC external power supply
FX5-SF-MU4T5*1*2	Safety main module 4-points safety input/4-points safety output	8 points	200 mA	5 mA	125 mA
FX5-SF-8DI4*2	Safety input expansion module 8-points safety input	0 points	—	—	125 mA*3

*1: Locate these modules on the rightmost side of the system configuration. However, this does not apply when the safety input extension module is connected. They cannot be used together with the bus conversion module or FX3 extension module.

*2: Supported by FX5UJ CPU modules Ver. 1.010 or later.

*3: Supplied from external 24 V DC power supply of the FX5-SF-MU4T5.

Limitation on the number of modules connected to the CPU module

There is a limitation on the number of extension modules connected to the CPU module, as shown on the right.

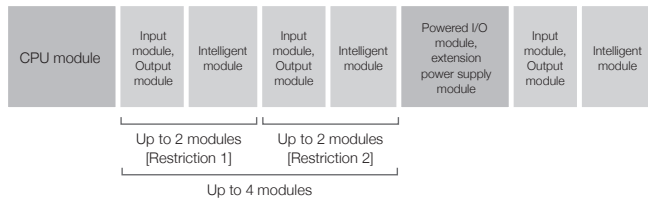

[Restriction 1]

- Up to 2 modules can be connected.
- The total number of the input/output points occupied by the extension modules must be 32 or less.
- When 32 input/output points are occupied by the first module, the [Restriction 2] shall apply to the connection of the second and following modules.

[Restriction 2]

- Up to 2 modules can be connected.
- If one extension module is connected, 200 mA of 24 V DC service power supply will be consumed unconditionally.
- If the 24 V DC service power supply is insufficient, such as external power for the extension module is supplied from the 24 V DC service power supply of the CPU module, the extension module cannot be connected.

Calculation of current consumed by extension modules

The power required for the expansion adapter, expansion board and extension module is supplied from the CPU module or extension power supply module. Use the following calculations to confirm whether the required power can be supplied. (All calculations must be satisfied.)

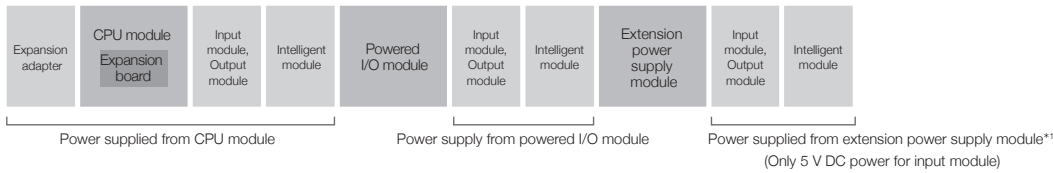

■ Power supply from CPU module

[24 V DC power supply]

$$\begin{matrix} \text{24 V DC} \\ \text{service power supply capacity} \\ \text{(CPU module)} \end{matrix} - \begin{matrix} \text{Total current consumption} \\ \text{(Total no. of extension devices} \\ \text{to be connected)} \end{matrix} = \text{Calculation results} \geq \text{0 mA}^{*2}$$

■ Power supply from powered I/O module

[5 V DC power supply]

$$\begin{matrix} \text{5 V DC power supply capacity} \\ \text{(Powered I/O module)} \end{matrix} - \begin{matrix} \text{Total current consumption} \\ \text{(Total no. of extension devices} \\ \text{to be connected)} \end{matrix} = \text{Calculation results} \geq \text{0 mA}$$

[24 V DC power supply]

$$\begin{matrix} \text{24 V DC} \\ \text{service power supply capacity} \\ \text{(Powered I/O module)} \end{matrix} - \begin{matrix} \text{Total current consumption} \\ \text{(Total no. of extension devices} \\ \text{to be connected)} \end{matrix} = \text{Calculation results} \geq \text{0 mA}^{*2}$$

■ Power supply from extension power supply module

[5 V DC power supply]

$$\begin{matrix} \text{5 V DC power supply capacity} \\ \text{(Extension power supply module)} \end{matrix} - \begin{matrix} \text{Total current consumption} \\ \text{(Total no. of extension devices} \\ \text{to be connected)} \end{matrix} = \text{Calculation results} \geq \text{0 mA}$$

[24 V DC power supply]

$$\begin{matrix} \text{24 V DC power supply capacity} \\ \text{(Extension power supply module)} \end{matrix} - \begin{matrix} \text{Total current consumption} \\ \text{(Total no. of extension devices} \\ \text{to be connected)} \end{matrix} = \text{Calculation results} \geq \text{0 mA}$$

<Cautions>
If the calculation results are negative, the power capacity is exceeded so review the system configuration.

*1: When connecting an input module to the back stage (right side) of the extension power supply module, power will be supplied from the CPU module or a powered I/O module.
5 V DC power is supplied from an extension power supply module.

*2: The 24 V DC service power calculation results value (when positive) indicates the 24 V DC service power supply's remaining capacity, and can be used as an external load power.

Refer to the next section for the details of some products since the number of connected modules may be limited.

Rules for System Configuration

The total number of I/O points and remote I/O points for the CPU module and extension devices controllable in FX5UJ CPU module is 256 points or less.

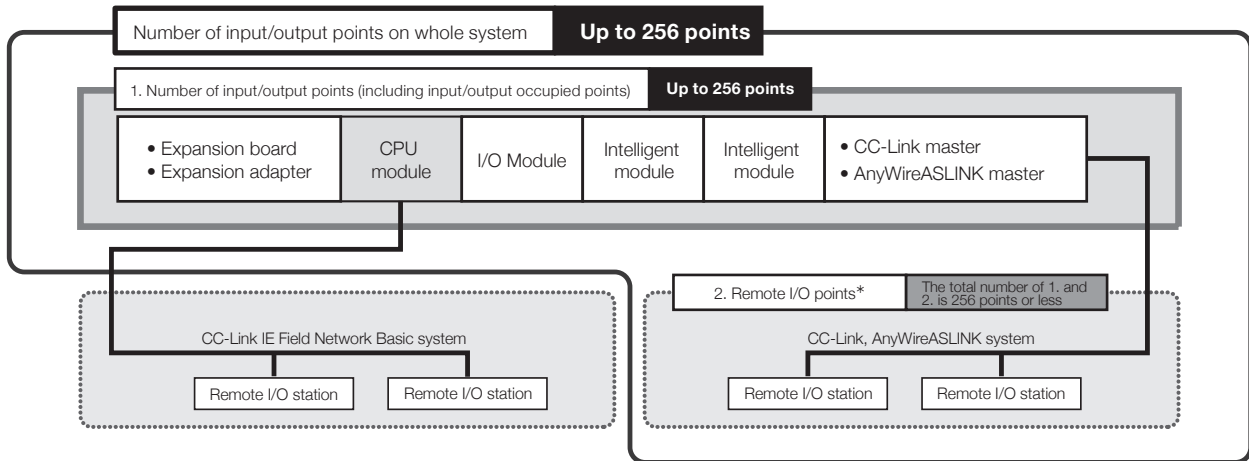

Number of input/output points

The maximum number of I/O points that can be configured with FX5UJ is as follows.

Maximum number of input/output points	Number of occupied I/O points			
256 points	≥	CPU module	I/O module	Intelligent module
		(A) points	+ Total (B) points	+ (C) modules × 8 points

The number of occupied I/O points does not include those of the expansion adapters, expansion boards, connector conversion modules, and extension power supply modules.

(A): Number of input/output points of CPU module (B): Total number of input/output points of I/O module (C): Total number of intelligent modules

About remote I/O points

The maximum number of I/O points when using a network master module is as follows.

Maximum number of remote I/O points	Number of occupied remote I/O points*		
256 points - Number of occupied remote I/O points	≥	CC-Link	AnyWireASLINK
		(D) points	+ (E) points

(D) Number of CC-Link remote I/O points

Maximum number of CC-Link remote I/O points	Remote I/O points	The total number of remote I/O points in CC-Link
192 points	≥	=
	points	stations × 32 points

(E) Number of AnyWireASLINK remote I/O points

Maximum number of AnyWire ASLINK remote I/O points	AnyWireASLINK remote I/O points
216 points	≥
	points

*: CC-Link IE Field Network Basic remote I/O stations are not calculated as remote I/O points.

Limitation on power supply type when connecting

The power supply type is limited for extension modules connectable to the following CPU modules. For details, refer to the manual.

Type/model/power supply type	Connectable extension module	
	Type	Model/power supply type
FX5UJ CPU module FX5UJ-□M□/E□ (AC power supply type)	Powered I/O module	FX5-32E□/E□ (AC power supply type)
	Extension power supply module	FX5-1PSU-5V (AC power supply type)

Limitation on number of modules when extending

The number of connectable modules is limited for the following products. For details, refer to the manual.

Type	Model/type	Setting method/precautions
FX5 intelligent function module	FX5-CCL-MS	Only 1 module can be connected in the entire system for each station type. <ul style="list-style-type: none"> Master station: 1 module Intelligent device station: 1 module
	FX5-ENET	Only 1 module can be connected in the entire system.
	FX5-ENET/IP	
	FX5-CCLIEF	
	FX5-DP-M	
	FX5-ASL-M	
	FX5-40SSC-S	Only 1 module may be connected per system. Use together with the FX5-80SSC-S is not possible.
FX5-80SSC-S	Only 1 module may be connected per system. Use together with the FX5-40SSC-S is not possible.	
FX5 expansion adapter	FX5-232ADP	Up to 2 modules can be connected for the entire system.
	FX5-485ADP	When an extension board is connected to the CPU module, only 1 module can be connected.
	FX5-4A-ADP	Up to 2 modules can be connected for the entire system.
	FX5-4AD-ADP	
	FX5-4DA-ADP	
	FX5-4AD-PT-ADP	
	FX5-4AD-TC-ADP	
FX5 safety extension module	FX5-SF-MU4T5	Only 1 module can be connected in the entire system. Place this module on the rightmost side of the system configuration, except when FX5-SF-8DI4 is connected.
	FX5-SF-8DI4	Up to 2 modules can be connected for the entire system. Connect immediately after FX5-SF-MU4T5 and place this module on the rightmost side of the system configuration.

Selecting the FX5U model

◇ Product configuration

FX5U

- Control scale: 32 to 384 points (CPU module: 32/64/80 points)
- Control points up to 512 input/output points, including remote I/O*

*: For CC-Link and AnyWireASLINK

* For details about the connection positions, refer to the manual.

Type	Details	Connection details, model selection
1 CPU module	PLC with built-in CPU, power supply, input/output and program memory.	Various extension devices can be connected.
2 4 I/O module (extension cable type)	Product for extending I/O of extension cable type. Some products are powered.	The maximum number of input and output points for the entire system is 256 points/384 points*1. Up to 16 extension modules can be connected. (Extension power supply modules and connector conversion modules are not included in the number of connected modules.) Up to 4 high-speed pulse I/O modules can be connected. For details, refer to "Rules for System Configuration" on p. 77.
3 FX5 extension power supply module	Module for extending power supply if CPU module's internal power supply is insufficient. Extension cable is enclosed.	Power can be supplied to I/O module, intelligent function module, and bus conversion module. Up to 2 modules can be connected.
5 FX5 intelligent function module	Module with functions other than input/output.	Up to 16 extension modules including the I/O module can be connected (Extension power supply modules and connector conversion modules are not included in the number of connected modules.)
6 Connector conversion module	Module for connecting FX5 Series (extension connector type) extension module.	An extension module (extension connector type) for FX5 can be connected.
7 I/O module (Extension connector type)	Product for adding extension connector type inputs/outputs.	The maximum number of input and output points for the entire system is 256 points/384 points*1. Up to 16 extension modules can be connected. (Extension power supply modules and connector conversion modules are not included in the number of connected modules.) Using this type of I/O module requires the connector conversion module.
8 Bus conversion module	Conversion module for connecting FX3 Series extension module.	FX3 extension module can be connected only to the right side of the bus conversion module. When using FX5-CNV-BUSC, a connector conversion module is required.
9 FX5 expansion board	Board connected to front of CPU module to expand functions.	Up to 1 module can be connected to the front of the CPU module. (Expansion adapter can also be used.)
10 FX5 expansion adapter	Adapter connected to left side of CPU module to expand functions.	Up to 2 communication adapters and up to 4 analog adapters*2 (up to 6 adapters in total) can be connected on the left side of the CPU module. When 9 is used, the number is limited.
11 FX3 extension power supply module	Module for extending power supply if CPU module's internal power supply is insufficient. Extension cable is enclosed.	Up to 2 modules can be connected. The bus conversion module is required for use.
12 FX3 intelligent function module	Module with functions other than input/output.	When using the FX3 extension power supply module, up to 8 modules*3 can be used. When not using the FX3 extension power supply module, up to 6 modules*3 can be used. The bus conversion module is required for use.
13 FX5 safety extension module	Module for configuring a safety control system.	Up to 1 safety main module and up to 2 safety input extension modules can be connected. Extension modules cannot be connected on the downstream side (right side) of any safety extension module. Bus conversion modules and FX3 extension modules cannot be used simultaneously.

*1: Supported by FX5U CPU modules Ver. 1.100 or later and by GX Works3 Ver. 1.047Z or later.

*2: Up to 2 modules of the FX5-4A-ADP can be connected in the entire system.

*3: Excluding some models

1 -1) CPU module (AC power supply, DC input type)

Model	Function	Number of occupied input/output points	Power supply capacity		I/O type	No. of input points	No. of output points
			5 V DC power supply	24 V DC service power supply			
FX5U-32MR/ES	CPU module (24 V DC service power built-in)	32 points	900 mA	400 mA (480 mA*) [300 mA (380 mA*)]*2	DC input (sink/source)/relay output	16 points	16 points
FX5U-32MT/ES					DC input (sink/source)/transistor (sink)		
FX5U-32MT/ESS					DC input (sink/source)/transistor (source)		
FX5U-64MR/ES		64 points	1100 mA	600 mA (740 mA*) [300 mA (440 mA*)]*2	DC input (sink/source)/relay output	32 points	32 points
FX5U-64MT/ES					DC input (sink/source)/transistor (sink)		
FX5U-64MT/ESS					DC input (sink/source)/transistor (source)		
FX5U-80MR/ES		80 points	1100 mA	600 mA (770 mA*) [300 mA (470 mA*)]*2	DC input (sink/source)/relay output	40 points	40 points
FX5U-80MT/ES					DC input (sink/source)/transistor (sink)		
FX5U-80MT/ESS					DC input (sink/source)/transistor (source)		

*1: Power supply capacity when an external power supply is used for input circuits.

*2: Value inside [] indicates the power supply capacity when the CPU module is used at the operating ambient temperature of less than 0°C.

1 -2) CPU module (DC power supply/DC input type)

Model	Function	Number of occupied input/output points	Power supply capacity		I/O type	No. of input points	No. of output points
			5 V DC power supply	24 V DC power supply			
FX5U-32MR/DS	CPU module	32 points	900 mA [775 mA]*	480 mA [360 mA]*	DC input (sink/source)/relay output	16 points	16 points
FX5U-32MT/DS					DC input (sink/source)/transistor output (sink)		
FX5U-32MT/DSS					DC input (sink/source)/transistor output (source)		
FX5U-64MR/DS		64 points	1100 mA [975 mA]	740 mA [530 mA]*	DC input (sink/source)/relay output	32 points	32 points
FX5U-64MT/DS					DC input (sink/source)/transistor output (sink)		
FX5U-64MT/DSS					DC input (sink/source)/transistor output (source)		
FX5U-80MR/DS		80 points	1100 mA [975 mA]	770 mA [560 mA]*	DC input (sink/source)/relay output	40 points	40 points
FX5U-80MT/DS					DC input (sink/source)/transistor output (sink)		
FX5U-80MT/DSS					DC input (sink/source)/transistor output (source)		

*: Value inside [] indicates the power supply capacity when the supply voltage is 16.8 to 19.2 V DC.

2 -1) I/O module (AC power supply/DC input type) (extension cable type)

Model	Function	Number of occupied input/output points	Power supply capacity		I/O type	No. of input points	No. of output points
			5 V DC power supply	24 V DC service power supply			
FX5-32ER/ES*1	I/O module (24 V DC service power built-in)	32 points	965 mA	250 mA (310 mA*2)	DC input (sink/source)/relay output	16 points	16 points
FX5-32ET/ES*1					DC input (sink/source)/transistor (sink)		
FX5-32ET/ESS*1					DC input (sink/source)/transistor (source)		

*1: Can be connected only to the AC power type system

*2: Power supply capacity when an external power supply is used for input circuits.

2 -2) I/O module (DC power supply/DC input type) (extension cable type)

Model	Function	Number of occupied input/output points	Power supply capacity		I/O type	No. of input points	No. of output points
			5 V DC power supply	24 V DC power supply			
FX5-32ER/DS*	I/O module	32 points	965 mA	310 mA	DC input (sink/source)/relay output	16 points	16 points
FX5-32ET/DS*					DC input (sink/source)/transistor output (sink)		
FX5-32ET/DSS*					DC input (sink/source)/transistor output (source)		

*: Can be connected only to the DC power type system

3 FX5 extension power supply module

Model	Function	Number of occupied input/output points	Power supply capacity	
			5 V DC power supply	24 V DC power supply
FX5-1PSU-5V*1	Extension power supply	—	1200 mA*3	300 mA*3
FX5-C1PS-5V*2	Extension power supply	—	1200 mA*3	625 mA*3

*1: Can be connected only to the AC power type system

*2: Can be connected only to the DC power type system

*3: Derating occurs when the ambient temperature exceeds 40°C. For details, refer to the manual.

4 I/O module (extension cable type)

Model	I/O type	Number of occupied input/output points	Current consumption	
			5 V DC power supply	24 V DC power supply
FX5-8EX/ES	DC input (sink/source)	8 points	75 mA	50 mA (0 mA*2)
FX5-16EX/ES	DC input (sink/source)	16 points	100 mA	85 mA (0 mA*2)
FX5-8EYR/ES	Relay output	8 points	75 mA	75 mA
FX5-8EYT/ES	Transistor output (sink)			
FX5-8EYT/ESS	Transistor output (source)			
FX5-16EYR/ES	Relay output	16 points	100 mA	125 mA
FX5-16EYT/ES	Transistor output (sink)			
FX5-16EYT/ESS	Transistor output (source)			
FX5-16ER/ES	DC input (sink/source)/relay output	16 points	100 mA	125 mA (85 mA*2)
FX5-16ET/ES	DC input (sink/source)/transistor output (sink)			
FX5-16ET/ESS	DC input (sink/source)/transistor output (source)			
FX5-16ET/ES-H*1	DC input (sink/source)/transistor output (sink)	16 points	100 mA	125 mA (85 mA*2)
FX5-16ET/ESS-H*1	DC input (sink/source)/transistor output (source)			

*1: Supported by FX5U/FX5UC CPU module Ver. 1.030 or later.

*2: Current consumption when an external power supply is used for input circuits.

5 FX5 intelligent function module

Model	Function	Number of occupied input/output points	Current consumption		
			5 V DC power supply	24 V DC power supply	24 V DC external power supply
FX5-4AD*1	4-ch voltage/current input	8 points	100 mA	40 mA	—
FX5-4DA*1	4-ch voltage/current output	8 points	100 mA	—	150 mA
FX5-8AD*1	8-ch voltage/current/thermocouple/resistance temperature detector input	8 points	—	40 mA	100 mA
FX5-4LC*1	4-ch temperature control (resistance temperature detector/thermocouple/micro voltage)	8 points	140 mA	—	25 mA
FX5-20PG-P*1	Pulse output for 2-axis control (transistor output)	8 points	—	—	120 mA
FX5-20PG-D*1	Pulse output for 2-axis control (differential driver output)	8 points	—	—	165 mA
FX5-40SSC-S	Simple motion 4-axis control (SSCNET III/H compatible)	8 points	—	—	250 mA
FX5-80SSC-S	Simple motion 8-axis control (SSCNET III/H compatible)	8 points	—	—	250 mA
FX5-40SSC-G*2	Motion 4-axis control (CC-Link IE TSN compatible)	8 points	—	—	240 mA
FX5-80SSC-G*2	Motion 8-axis control (CC-Link IE TSN compatible)	8 points	—	—	240 mA
FX5-CCLGN-MS*3	CC-Link IE TSN master/local	8 points	—	—	220 mA
FX5-ENET*4	Ethernet communication	8 points	—	110 mA	—
FX5-ENET/IP*4	EtherNet/IP communication, Ethernet communication	8 points	—	110 mA	—
FX5-CCL-MS*1	CC-Link system master/intelligent device station	8 points*5	—	—	100 mA
FX5-CCLIEF*6	CC-Link IE Field Network intelligent device station	8 points	10 mA	—	230 mA
FX5-ASL-M*1	AnyWireASLINK system master	8 points	200 mA	—	100 mA*7
FX5-DP-M*4	PROFIBUS-DP master	8 points	—	150 mA	—
FX5-OPC*8	OPC UA communication	8 points	—	110 mA	—

- *1: Supported by FX5U/FX5UC CPU module Ver. 1.050 or later.
- *2: Supported by FX5U/FX5UC CPU module Ver. 1.230 or later.
- *3: Supported by FX5U/FX5UC CPU module Ver. 1.210 or later.
- *4: Supported by FX5U/FX5UC CPU module Ver. 1.110 or later.
- *5: When using FX5-CCL-MS as a master station, the number of remote I/O points on the network increases.
- *6: Supported by FX5U/FX5UC CPU module Ver. 1.030 or later.
- *7: This value does not include the supply current to slave modules (Max. 2 A).
- *8: Supported by FX5U/FX5UC CPU module Ver. 1.245 or later.

6 Connector conversion module

Model	Function	Number of occupied input/output points	Current consumption	
			5 V DC power supply	24 V DC power supply
FX5-CNV-IF	Connector conversion (FX5 (Extension cable type) →FX5 (Extension connector type))	—	—	—

7 I/O module (Extension connector type)

Model	I/O type	Number of occupied input/output points	Current consumption	
			5 V DC power supply	24 V DC power supply
FX5-C16EX/D	DC input (sink)	16 points	100 mA	65 mA (0 mA*)
FX5-C16EX/DS	DC input (sink/source)			
FX5-C32EX/D	DC input (sink)	32 points	120 mA	130 mA (0 mA*)
FX5-C32EX/DS	DC input (sink/source)			
FX5-C32EX/DS-TS	DC input (sink/source)			
FX5-C16EYT/D	Transistor output (sink)	16 points	100 mA	100 mA
FX5-C16EYT/DSS	Transistor output (source)			
FX5-C16EYR/D-TS	Relay output			
FX5-C32EYT/D	Transistor output (sink)	32 points	120 mA	200 mA
FX5-C32EYT/DSS	Transistor output (source)			
FX5-C32EYT/D-TS	Transistor output (sink)			
FX5-C32EYT/DSS-TS	Transistor output (source)			
FX5-C32ET/D	DC input (sink)/transistor output (sink)	32 points	120 mA	165 mA (100 mA*)
FX5-C32ET/DSS	DC input (sink/source)/transistor output (source)			
FX5-C32ET/DS-TS	DC input (sink/source)/transistor output (sink)			
FX5-C32ET/DSS-TS	DC input (sink/source)/transistor output (source)			

- *: Current consumption when an external power supply is used for the input circuits.

8 Bus conversion module

Model	Function	Number of occupied input/output points	Current consumption	
			5 V DC power supply	24 V DC power supply
FX5-CNV-BUSC	Bus conversion FX5 (extension cable type) → FX3 extension	8 points	150 mA	—
FX5-CNV-BUS	Bus conversion FX5 (extension cable type) → FX3 extension			

9 FX5 expansion board

Model	Function	Number of occupied input/output points	Current consumption	
			5 V DC power supply	24 V DC power supply
FX5-232-BD	RS-232C communication	—	20 mA	—
FX5-485-BD	RS-485 communication			
FX5-422-BD-GOT	RS-422 communication (for GOT connection)			

*: The current consumption will increase when the 5 V type GOT is connected.

10 FX5 expansion adapter

Model	Function	Number of occupied input/output points	Current consumption		
			5 V DC power supply	24 V DC power supply	24 V DC external power supply
FX5-232ADP	RS-232C communication	—	30 mA	30 mA	—
FX5-485ADP	RS-485 communication		20 mA		
FX5-4A-ADP*1	2 ch voltage input/current input, 2 ch voltage output/current output		10 mA	—	100 mA
FX5-4AD-ADP	4 ch voltage input/current input		10 mA	20 mA	—
FX5-4AD-PT-ADP*2	4 ch temperature sensor (resistance temperature detector) input				
FX5-4AD-TC-ADP*2	4 ch temperature sensor (thermocouple) input				
FX5-4DA-ADP	4 ch voltage output/current output		—	—	160 mA

*1: Supported by FX5U/FX5UC CPU module Ver. 1.240 or later.

*2: Supported by FX5U/FX5UC CPU module Ver. 1.040 or later.

11 FX3 extension power supply module

Model	Function	Number of occupied input/output points	Current consumption	
			5 V DC power supply	24 V DC power supply
FX3U-1PSU-5V	Extension power supply	—	1000 mA*	300 mA*

*: Derating occurs when the ambient temperature exceeds 40°C. For details, refer to the manual.

12 FX3 intelligent function module

Model	Function	Number of occupied input/output points	Current consumption			
			5 V DC power supply	24 V DC power supply	24 V DC external power supply	
FX3U-4AD	4 ch voltage input/current input	8 points	110 mA	—	90 mA	
FX3U-4DA	4 ch voltage output/current output		120 mA		160 mA	
FX3U-4LC	4-loop temperature control (resistance thermometer/thermocouple/micro voltage)		160 mA		50 mA	
FX3U-1PG	Pulse output for 1-axis control		150 mA		40 mA	
FX3U-2HC	2 ch high-speed counter		245 mA		—	
FX3U-16CCL-M	CC-Link master		8 points*1		—	240 mA
FX3U-64CCL	CC-Link intelligent device station		8 points		—	220 mA
FX3U-128ASL-M	AnyWireASLINK system master	8 points*2	130 mA	100 mA*3		
FX3U-32DP	PROFIBUS-DP slave station	8 points	—	145 mA	—	

*1: When using FX3U-16CCL-M as a master station, the number of remote I/O points on the network increases.

*2: The number of input/output points set by the rotary switch is added.

*3: This value does not include the supply current to slave modules (Max. 2 A).

13 FX5 safety extension module

Model	Function	Number of occupied input/output points	Current consumption		
			5 V DC power supply	24 V DC power supply	24 V DC external power supply
FX5-SF-MU4T5*1*2	Safety main module 4-points safety input/4-points safety output	8 points	200 mA	5 mA	125 mA
FX5-SF-8DJ4*2	Safety input expansion module 8-points safety input	0 points	—	—	125 mA*3

*1: Locate these modules on the rightmost side of the system configuration. However, this does not apply when the safety input extension module is connected. They cannot be used together with the bus conversion module or FX3 extension module.

*2: Supported by FX5U/FX5UC CPU module Ver. 1.200 or later.

*3: Supplied from external 24 V DC power supply of the FX5-SF-MU4T5.

Calculation of current consumed by extension modules (For the AC power supply type)*1

The power required for the expansion adapter, expansion board and extension module is supplied from the CPU module or extension power supply module. Use the following calculations to confirm whether the required power can be supplied. (All calculations must be satisfied.)

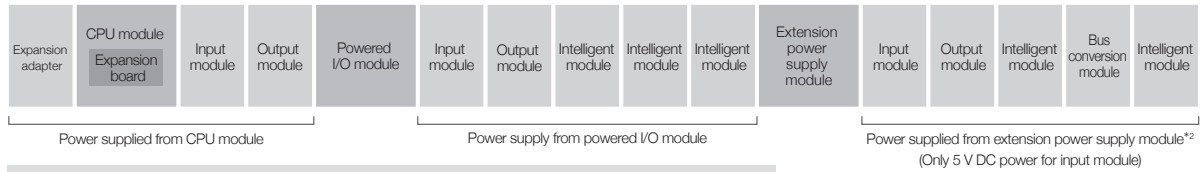

■ Power supply from CPU module

[5 V DC power supply]

5 V DC power supply capacity (CPU module)	-	Total current consumption (Total no. of extension devices to be connected)	=	Calculation results	≥	0 mA
---	---	--	---	---------------------	---	------

[24 V DC power supply]

24 V DC service power supply capacity (CPU module)	-	Total current consumption (Total no. of extension devices to be connected)	=	Calculation results	≥	0 mA*3
--	---	--	---	---------------------	---	--------

■ Power supply from powered I/O module

[5 V DC power supply]

5 V DC power supply capacity (Powered I/O module)	-	Total current consumption (Total no. of extension devices to be connected)	=	Calculation results	≥	0 mA
---	---	--	---	---------------------	---	------

[24 V DC power supply]

24 V DC service power supply capacity (Powered I/O module)	-	Total current consumption (Total no. of extension devices to be connected)	=	Calculation results	≥	0 mA*3
--	---	--	---	---------------------	---	--------

■ Power supply from extension power supply module*4

[5 V DC power supply]

5 V DC power supply capacity (Extension power supply module)	-	Total current consumption (Total no. of extension devices to be connected)	=	Calculation results	≥	0 mA
--	---	--	---	---------------------	---	------

[24 V DC power supply]

24 V DC power supply capacity (Extension power supply module)	-	Total current consumption (Total no. of extension devices to be connected)	=	Calculation results	≥	0 mA
---	---	--	---	---------------------	---	------

<Cautions>

If the calculation results are negative, the power capacity is exceeded so review the system configuration.

Refer to the next section for the details of some products since the number of connected modules may be limited.

*1: For calculation for the DC power supply type, refer to the manual.
 *2: When connecting an input module to the back stage (right side) of the extension power supply module, power will be supplied from the CPU module or a powered I/O module.
 5 V DC power is supplied from an extension power supply module.
 *3: The 24 V DC service power calculation results value (when positive) indicates the 24 V DC service power supply's remaining capacity, and can be used as an external load power.
 *4: When using FX3 extension power supply module, another calculation is required. For details, refer to the manual.

Rules for System Configuration

The total number of I/O points and remote I/O points for the CPU module and extension devices controllable in FX5U CPU module is 512 points or less.

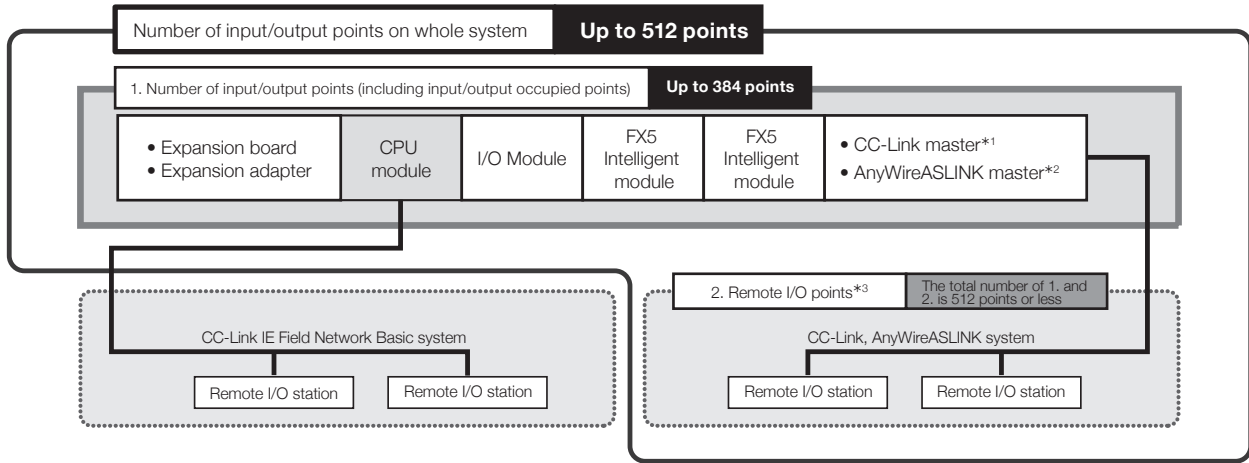

Number of input/output points

The maximum number of I/O points that can be configured with FX5U is as follows.

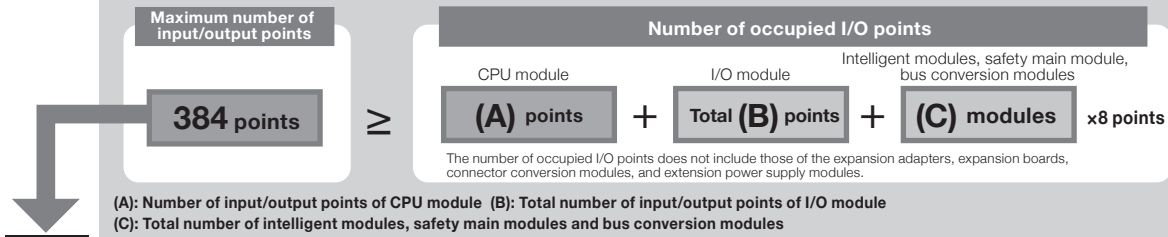

About remote I/O points

The maximum number of I/O points when using a network master module is as follows.

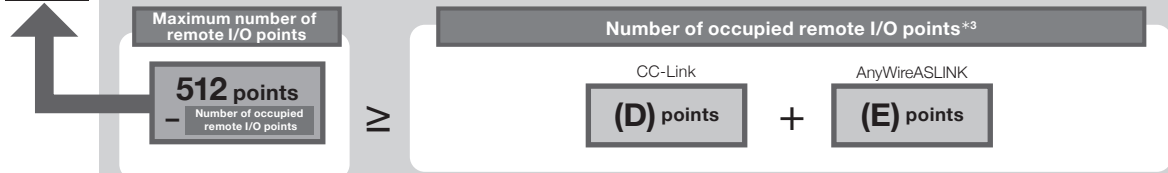

(D) Number of CC-Link remote I/O points

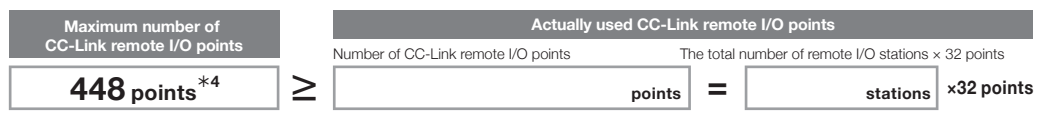

(E) Number of AnyWireASLINK remote I/O points

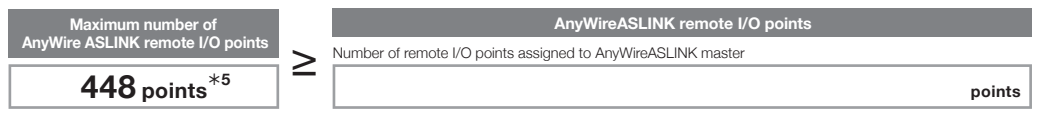

*1: A bus conversion module is required when using the FX3U-16CCL-M.
 *2: A bus conversion module is required when using the FX3U-128ASL-M.
 *3: CC-Link IE Field Network Basic remote I/O stations are not calculated as remote I/O points.
 *4: 256 points when FX3U-16CCL-M is used.
 *5: 128 points when FX3U-128ASL-M is used.

The number of points will vary if the CPU module firmware version is below 1.110. For details, refer to the manual.

Lineup Details/Model Selection

Limitation on power supply type when connecting

It is not possible to install both the AC type and the DC type in one system.

The power supply type is limited for extension modules connectable to the following CPU modules. For details, refer to the manual.

Type/model/power supply type	Connectable extension module	
	Type	Model/power supply type
FX5U CPU module FX5U-□M□/E□ (AC power supply type)	Powered I/O module	FX5-32E□/E□ (AC power supply type)
	Extension power supply module	FX5-1PSU-5V (AC power supply type)
FX5U CPU module FX5U-□M□/D□ (DC power supply type)	Powered I/O module	FX5-32E□/D□ (DC power supply type)
	Extension power supply module	FX5-C1PS-5V (DC power supply type)

Limitation on number of modules when extending

The number of connectable modules is limited for the following products. For details, refer to the manual.

Type	Model/type	Setting method/precautions
I/O module (Extension cable type)	FX5-16ET/ES-H	Up to 4 modules can be connected for the entire system.
	FX5-16ET/ESS-H	
FX5 intelligent function module	FX5-CCLGN-MS	Only 1 module can be connected in the entire system for each station type. <ul style="list-style-type: none"> Master station: 1 module Local station: 1 module When 4 modules of the FX5-40SSC-G and FX5-80SSC-G are connected to the entire system, the FX5-CCLGN-MS (master station) cannot be connected.
	FX5-CCL-MS	Only 1 module can be connected in the entire system for each station type. <ul style="list-style-type: none"> Master station: 1 module*1 Intelligent device station: 1 module*2
	FX5-ENET	Only 1 module can be connected in the entire system.
	FX5-ENET/IP	
	FX5-CCLIEF	
	FX5-DP-M	
	FX5-OPC	
	FX5-ASL-M	Only 1 module can be connected in the entire system. Use together with the FX3U-128ASL-M is not possible.
FX5-40SSC-G	Up to 4 modules can be connected for the entire system. Up to 4 modules of the FX5-40SSC-G, FX5-80SSC-G, and FX5-CCLGN-MS (master station) can be connected in total. The FX5-SF-MU4T5 and FX5-SF-8DI4 cannot be used simultaneously.	
FX5-80SSC-G	Up to 4 modules can be connected for the entire system. Up to 4 modules of the FX5-40SSC-G, FX5-80SSC-G, and FX5-CCLGN-MS (master station) can be connected in total. The FX5-SF-MU4T5 and FX5-SF-8DI4 cannot be used simultaneously.	
FX5 expansion adapter	FX5-232ADP	Up to 2 modules can be connected for the entire system.
	FX5-485ADP	
	FX5-4A-ADP*3	Up to 2 modules can be connected for the entire system.
	FX5-4AD-ADP	Up to 4 modules can be connected for the entire system.
	FX5-4DA-ADP	
	FX5-4AD-PT-ADP	
FX5-4AD-TC-ADP*4		
FX5 safety extension module	FX5-SF-MU4T5	Only 1 module can be connected in the entire system. This module cannot be used together with the bus conversion module or FX3 extension module. The FX5-40SSC-G and FX5-80SSC-G cannot be used simultaneously. Locate the module on the rightmost side of the system configuration. However, this does not apply when the safety input extension module is connected.
	FX5-SF-8DI4	Up to 2 modules can be connected for the entire system. This module cannot be used together with the bus conversion module or FX3 extension module. The FX5-40SSC-G and FX5-80SSC-G cannot be used simultaneously. Connect the module just after FX5-SF-MU4T5, and locate it on the rightmost side of the system configuration.
FX3 intelligent function module	FX3U-4AD	<ul style="list-style-type: none"> When using FX3U-1PSU-5V: Up to 8 modules can be connected per system. When not using FX3U-1PSU-5V: Up to 6 modules can be connected per system.
	FX3U-4DA	
	FX3U-1PG	
	FX3U-4LC	
	FX3U-128ASL-M	Only 1 module can be connected in the entire system. It cannot be used together with the FX5-ASL-M.
	FX3U-16CCL-M	Only 1 module can be connected in the entire system. When using the FX5-CCL-MS as the master station, it cannot be used together with the FX5-CCL-MS.
	FX3U-64CCL	Only 1 module can be connected in the entire system. When using the FX5-CCL-MS as the intelligent device station, it cannot be used together with the FX5-CCL-MS.
FX3U-2HC	Up to 2 modules can be connected for the entire system. When not using the FX3U-1PSU-5V, connect immediately after the bus conversion module.	

*1: When using the FX5-CCL-MS as the master station, it cannot be used together with the FX3U-16CCL-M.

*2: When using the FX5-CCL-MS as the intelligent device station, it cannot be used together with the FX3U-64CCL.

*3: Do not connect the FX5-4DA-ADP adjacent to both sides.

*4: Do not connect the FX5-4DA-ADP or FX5-4A-ADP adjacent to both sides.

memo

Selecting the FX5UC model

◇ Product configuration



FX5UC

- Control scale: 32 to 384 points (CPU module: 32/64/96 points)
- Control points up to 512 input/output points, including remote I/O*

*: For CC-Link and AnyWireASLINK

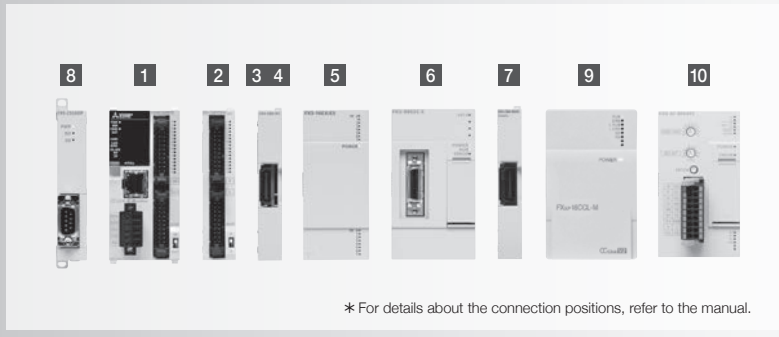

* For details about the connection positions, refer to the manual.

Type	Details	Connection details, model selection
1 CPU module	PLC with built-in CPU, power supply, input/output and program memory.	Various extension devices can be connected.
2 I/O module (extension connector type)	Product for extension I/O of extension connector type.	The maximum number of input and output points for the entire system is 256 points/384 points*1. Up to 16 extension modules can be connected. (Extension power supply modules and connector conversion modules are not included in the number of connected modules.) For details, refer to "Rules for System Configuration" on p. 85.
3 FX5 extension power supply module	Module for extension power supply if CPU module's internal power supply is insufficient. Connector conversion function is also provided.	Power can be supplied to I/O module, intelligent function module, and bus conversion module. Up to 2 modules can be connected.
4 Connector conversion module	Module for connecting FX5 (extension cable type) extension module	Extension devices (extension cable type) for FX5 can be connected.
5 I/O module (extension cable type)	Product for extending I/O of extension cable type.	The maximum number of input and output points for the entire system is 256 points/384 points*1. Up to 16 extension modules can be connected. (Connector conversion modules are not included in the number of connected modules.) Up to 4 high-speed pulse I/O modules can be connected. Using this type of I/O module requires the connector conversion module.
6 FX5 intelligent function module	Module with functions other than input/output.	Up to 16 extension modules including I/O modules can be connected. (Connector conversion modules are not included in the number of connected modules.) Using this type of module requires the connector conversion module.
7 Bus conversion module	Conversion module for connecting FX3 extension module.	FX3 Series extension modules can be connected only to the right side of the bus conversion module. Using the FX5-CNV-BUS requires the connector conversion module or extension power supply module.
8 FX5 expansion adapter	Adapter connected to left side of CPU module to expand functions.	Up to 2 communication adapters and up to 4 analog adapters*2 (up to 6 adapters in total) can be connected on the left side of the CPU module.
9 FX3 intelligent function module	Module with functions other than input/output.	Up to 6 modules*3 can be connected to the right side of the bus conversion module. The bus conversion module is required for use.
10 FX5 safety extension module	Module for configuring a safety control system.	Up to 1 safety main module and up to 2 safety input extension modules can be connected. Extension modules cannot be connected on the downstream side (right side) of any safety extension module. Bus conversion modules and FX3 extension modules cannot be used simultaneously.

*1: Supported by FX5U/FX5UC Ver. 1.100 or later and by GX Works3 Ver. 1.047Z or later.

*2: Up to 2 modules of the FX5-4A-ADP can be connected in the entire system.

*3: Excluding some models

1 CPU module

Model	Function	Number of occupied input/output points	Power supply capacity		I/O type	No. of input points	No. of output points
			5 V DC power supply	24 V DC power supply			
FX5UC-32MT/D	CPU module	32 points	720 mA	500 mA	DC input (sink)/transistor (sink)	16 points	16 points
FX5UC-32MT/DSS					DC input (sink/source)/transistor (source)		
FX5UC-32MT/DS-TS					DC input (sink/source)/transistor (sink)		
FX5UC-32MT/DSS-TS					DC input (sink/source)/transistor (source)		
FX5UC-32MR/DS-TS					DC input (sink/source)/relay output		
FX5UC-64MT/D		64 points			32 points	32 points	
FX5UC-64MT/DSS		DC input (sink/source)/transistor (source)			32 points	32 points	
FX5UC-96MT/D		96 points			DC input (sink)/transistor (sink)	48 points	48 points
FX5UC-96MT/DSS					DC input (sink/source)/transistor (source)	48 points	48 points

2 I/O module (extension connector type)

Model	I/O type	Number of occupied input/output points	Current consumption		
			5 V DC power supply	24 V DC power supply	24 V DC external power supply (24 V DC power supply for input circuit)
FX5-C16EX/D	DC input (sink)	16 points	100 mA	-	65 mA
FX5-C16EX/DS	DC input (sink/source)				
FX5-C32EX/D	DC input (sink)	32 points	120 mA	-	130 mA
FX5-C32EX/DS	DC input (sink/source)				
FX5-C32EX/DS-TS					
FX5-C16EYT/D	Transistor output (sink)	16 points	100 mA	100 mA	-
FX5-C16EYT/DSS	Transistor output (source)				
FX5-C16EYR/D-TS	Relay output				
FX5-C32EYT/D	Transistor output (sink)	32 points	120 mA	200 mA	-
FX5-C32EYT/DSS	Transistor output (source)				
FX5-C32EYT/D-TS	Transistor output (sink)				
FX5-C32EYT/DSS-TS	Transistor output (source)				
FX5-C32ET/D	DC input (sink)/transistor output (sink)	32 points	120 mA	100 mA	65 mA
FX5-C32ET/DSS	DC input (sink/source)/transistor output (source)				
FX5-C32ET/DS-TS	DC input (sink/source)/transistor output (sink)				
FX5-C32ET/DSS-TS	DC input (sink/source)/transistor output (source)				

3 FX5 extension power supply module

Model	Function	Number of occupied input/output points	Power supply capacity	
			5 V DC power supply	24 V DC power supply
FX5-C1PS-5V	Extension power supply	-	1200 mA*	625 mA*

*: Derating occurs when the ambient temperature exceeds 40°C. For details, refer to the manual.

4 Connector conversion module

Model	Function	Number of occupied input/output points	Current consumption	
			5 V DC internal current consumption	24 V DC internal current consumption
FX5-CNV-IFC	Connector conversion (FX5 (Extension connector type) → FX5 (Extension cable type))	-	-	-

5 -1) I/O module (DC power supply/DC input type) (extension cable type)

Model	Function	Number of occupied input/output points	Power supply capacity		I/O type
			5 V DC power supply	24 V DC power supply	
FX5-32ER/DS	Input/output module	32 points	965 mA	310 mA	DC input (sink/source)/relay output
FX5-32ET/DS					DC input (sink/source)/transistor output (sink)
FX5-32ET/DSS					DC input (sink/source)/transistor output (source)

Lineup Details/Model Selection

5 -2) I/O module (extension cable type)

Model	Function	Number of occupied input/output points	Current consumption		
			5 V DC power supply	24 V DC power supply	24 V DC external power supply (24 V DC power supply for input circuit)
FX5-8EX/ES	DC input (sink/source)	8 points	75 mA	—	50 mA
FX5-16EX/ES	DC input (sink/source)	16 points	100 mA	—	85 mA
FX5-8EYR/ES	Relay output	8 points	75 mA	75 mA	—
FX5-8EYT/ES	Transistor output (sink)				
FX5-8EYT/ESS	Transistor output (source)				
FX5-16EYR/ES	Relay output	16 points	100 mA	125 mA	—
FX5-16EYT/ES	Transistor output (sink)				
FX5-16EYT/ESS	Transistor output (source)				
FX5-16ER/ES	DC input (sink/source)/relay output	16 points	100 mA	85 mA	40 mA
FX5-16ET/ES	DC input (sink/source)/transistor output (sink)				
FX5-16ET/ESS	DC input (sink/source)/transistor output (source)				
FX5-16ET/ES-H*	DC input (sink/source)/transistor output (sink)	16 points	100 mA	85 mA	40 mA
FX5-16ET/ESS-H*	DC input (sink/source)/transistor output (source)				

*: Supported by FX5U/FX5UC CPU module Ver. 1.030 or later.

6 FX5 intelligent function module

Model	Function	Number of occupied input/output points	Current consumption		
			5 V DC power supply	24 V DC power supply	24 V DC external power supply
FX5-4AD*1	4-ch voltage/current input	8 points	100 mA	40 mA	—
FX5-4DA*1	4-ch voltage/current output	8 points	100 mA	—	150 mA
FX5-8AD*1	8-ch voltage/current/thermocouple/resistance temperature detector input	8 points	—	40 mA	100 mA
FX5-4LC*1	4-ch temperature control (resistance temperature detector/thermocouple/micro voltage)	8 points	140 mA	—	25 mA
FX5-20PG-P*1	Pulse output for 2-axis control (transistor output)	8 points	—	—	120 mA
FX5-20PG-D*1	Pulse output for 2-axis control (differential driver output)	8 points	—	—	165 mA
FX5-40SSC-S	Simple motion 4-axis control (SSCNET III/H compatible)	8 points	—	—	250 mA
FX5-80SSC-S	Simple motion 8-axis control (SSCNET III/H compatible)	8 points	—	—	250 mA
FX5-40SSC-G*2	Motion 4-axis control (CC-Link IE TSN compatible)	8 points	—	—	240 mA
FX5-80SSC-G*2	Motion 8-axis control (CC-Link IE TSN compatible)	8 points	—	—	240 mA
FX5-CCLGN-MS*3	CC-Link IE TSN master/local	8 points	—	—	220 mA
FX5-ENET*4	Ethernet communication	8 points	—	110 mA	—
FX5-ENET/IP*4	EtherNet/IP communication, Ethernet communication	8 points	—	110 mA	—
FX5-CCL-MS*1	CC-Link system master/intelligent device station	8 points*5	—	—	100 mA
FX5-CCLIEF*6	CC-Link IE Field Network intelligent device station	8 points	10 mA	—	230 mA
FX5-ASL-M*1	AnyWireASLINK system master	8 points	200 mA	—	100 mA*7
FX5-DP-M*4	PROFIBUS-DP master	8 points	—	150 mA	—
FX5-OPC*8	OPC UA communication	8 points	—	110 mA	—

*1: Supported by FX5U/FX5UC CPU module Ver. 1.050 or later.

*2: Supported by FX5U/FX5UC CPU module Ver. 1.230 or later.

*3: Supported by FX5U/FX5UC CPU module Ver. 1.210 or later.

*4: Supported by FX5U/FX5UC CPU module Ver. 1.110 or later.

*5: When using FX5-CCL-MS as a master station, the number of remote I/O points on the network increases.

*6: Supported by FX5U/FX5UC CPU module Ver. 1.030 or later.

*7: This value does not include the supply current to slave modules (Max. 2 A).

*8: Supported by FX5U/FX5UC CPU module Ver. 1.245 or later.

7 Bus conversion module

Model	Function	Number of occupied input/output points	Current consumption	
			5 V DC power supply	24 V DC power supply
FX5-CNV-BUSC	Bus conversion FX5 (extension connector type) → FX3 extension	8 points	150 mA	—
FX5-CNV-BUS	Bus conversion FX5 (extension cable type) → FX3 extension			

8 FX5 expansion adapter

Model	Function	Number of occupied input/output points	Current consumption		
			5 V DC power supply	24 V DC power supply	24 V DC external power supply
FX5-232ADP	RS-232C communication	—	30 mA	30 mA	—
FX5-485ADP	RS-485 communication		20 mA		
FX5-4A-ADP*1	2 ch voltage input/current input, 2 ch voltage output/current output		10 mA	—	100 mA
FX5-4AD-ADP	4 ch voltage input/current input		10 mA	20 mA	—
FX5-4AD-PT-ADP*2	4 ch temperature sensor (resistance temperature detector) input				
FX5-4AD-TC-ADP*2	4 ch temperature sensor (thermocouple) input				
FX5-4DA-ADP	4 ch voltage output/current output			—	

*1: Supported by FX5U/FX5UC CPU module Ver. 1.240 or later.
 *2: Supported by FX5U/FX5UC CPU module Ver. 1.040 or later.

9 FX3 intelligent function module

Model	Function	Number of occupied input/output points	Current consumption		
			5 V DC power supply	24 V DC power supply	24 V DC external power supply
FX3U-4AD	4 ch voltage input/current input	8 points	110 mA	—	90 mA
FX3U-4DA	4 ch voltage output/current output		120 mA		160 mA
FX3U-4LC	4-loop temperature control (resistance thermometer/thermocouple/micro voltage)		160 mA		50 mA
FX3U-1PG	Pulse output for 1-axis control		150 mA		40 mA
FX3U-2HC	2 ch high-speed counter		245 mA		—
FX3U-16CCL-M	CC-Link master		8 points*1		—
FX3U-64CCL	CC-Link intelligent device station	8 points	—	220 mA	
FX3U-128ASL-M	AnyWireASLINK system master	8 points*2	130 mA	—	100 mA*3
FX3U-32DP	PROFIBUS-DP slave station	8 points	—	145 mA	—

*1: When using FX3U-16CCL-M as a master station, the number of remote I/O points on the network increases.
 *2: The number of input/output points set by the rotary switch is added.
 *3: This value does not include the supply current to slave modules.

10 FX5 safety extension module

Model	Function	Number of occupied input/output points	Current consumption		
			5 V DC power supply	24 V DC power supply	24 V DC external power supply
FX5-SF-MU4T5*1*2	Safety main module 4-points safety input/4-points safety output	8 points	200 mA	5 mA	125 mA
FX5-SF-8DI4*2	Safety input expansion module 8-points safety input	0 points	—	—	125 mA*3

*1: Locate these modules on the rightmost side of the system configuration. However, this does not apply when the safety input extension module is connected. They cannot be used together with the bus conversion module or FX3 extension module.
 *2: Supported by FX5U/FX5UC CPU module Ver. 1.200 or later.
 *3: Supplied from external 24 V DC power supply of the FX5-SF-MU4T5.

Calculation of current consumed by extension modules

The power required for the expansion adapter and extension module is supplied from the CPU module.
Use the following calculations to confirm whether the required power can be supplied. (All calculations must be satisfied.)

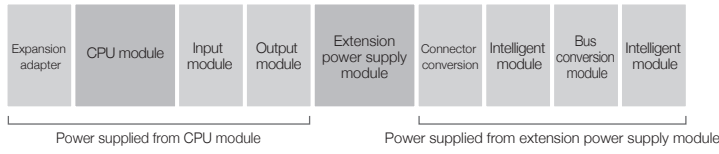

■ Power supply from CPU module [5 V DC power supply]

$$\text{5 V DC power supply capacity (CPU module)} - \text{Total current consumption (Total no. of extension devices to be connected)} = \text{Calculation results} \geq 0 \text{ mA}$$

[24 V DC power supply]

$$\text{24 V DC power supply capacity (CPU module)} - \text{Total current consumption (Total no. of extension devices to be connected)} = \text{Calculation results} \geq 0 \text{ mA}$$

■ Power supply from extension power supply module [5 V DC power supply]

$$\text{5 V DC power supply capacity (Extension power supply module)} - \text{Total current consumption (Total no. of extension devices to be connected)} = \text{Calculation results} \geq 0 \text{ mA}$$

[24 V DC power supply]

$$\text{24 V DC power supply capacity (Extension power supply module)} - \text{Total current consumption (Total no. of extension devices to be connected)} = \text{Calculation results} \geq 0 \text{ mA}$$

<Cautions>
If the calculation results are negative, the power capacity is exceeded so review the system configuration.

Refer to the next section for the details of some products since the number of connected modules may be limited.

Rules for System Configuration

The total number of I/O points and remote I/O points for the CPU module and extension devices controllable in FX5UC CPU module is 512 points or less.

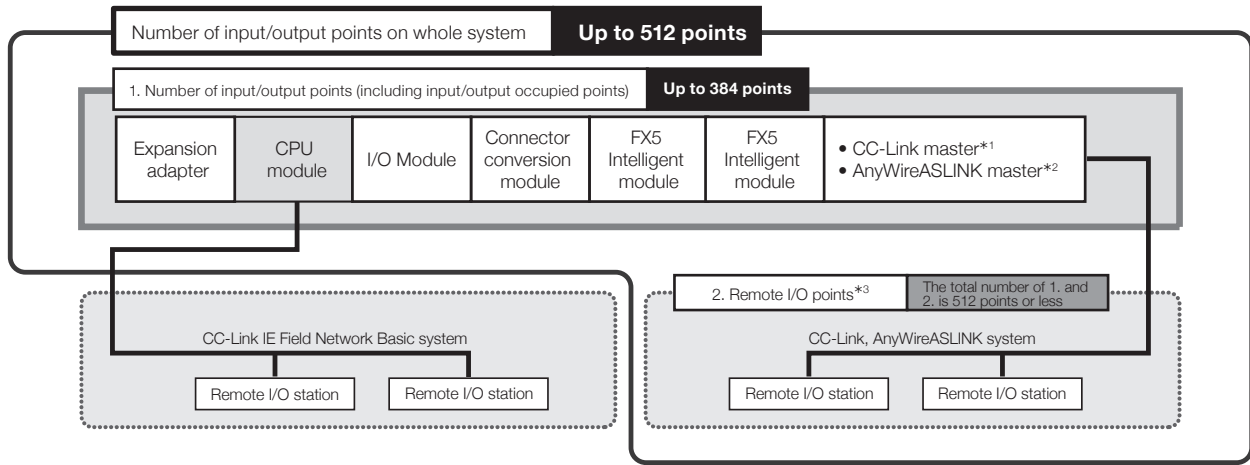

Number of input/output points

The maximum number of I/O points that can be configured with FX5UC is as follows.

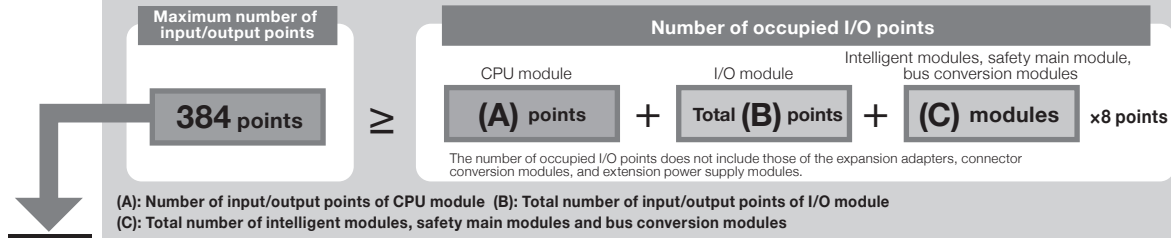

About remote I/O points

The maximum number of I/O points when using a network master module is as follows.

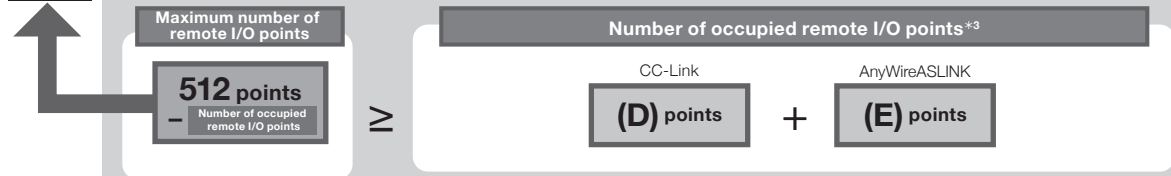

(D) Number of CC-Link remote I/O points

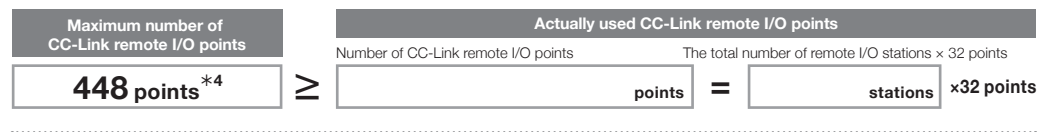

(E) Number of AnyWireASLINK remote I/O points

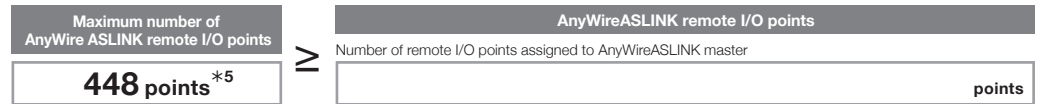

*1: A bus conversion module is required when using the FX3U-16CCL-M.
 *2: A bus conversion module is required when using the FX3U-128ASL-M.
 *3: CC-Link IE Field Network Basic remote I/O stations are not calculated as remote I/O points.
 *4: 256 points when FX3U-16CCL-M is used.
 *5: 128 points when FX3U-128ASL-M is used.

The number of points will vary if the CPU module firmware version is below 1.110. For details, refer to the manual.

Lineup Details/Model Selection

Limitation on power supply type when connecting

The power supply type is limited for extension modules connectable to the following CPU modules. For details, refer to the manual.

Type/model/power supply type	Connectable extension module	
	Type	Model/power supply type
FX5UC CPU module FX5UC-□□□/□□ (DC power supply type)	Powered I/O module	FX5-32E□/□□ (DC power supply type)
	Extension power supply module	FX5-C1PS-5V (DC power supply type)

Limitation on number of modules when extending

The number of connectable modules is limited for the following products. For details, refer to the manual.

Type	Model/type	Setting method/precautions
I/O module (Extension cable type)	FX5-16ET/ES-H	Up to 4 modules can be connected for the entire system.
	FX5-16ET/ESS-H	
FX5 intelligent function module	FX5-40SSC-G	Up to 4 modules can be connected for the entire system. Up to 4 modules of the FX5-40SSC-G, FX5-80SSC-G, and FX5-CCLGN-MS (master station) can be connected in total. The FX5-SF-MU4T5 and FX5-SF-8DI4 cannot be used simultaneously.
	FX5-80SSC-G	Up to 4 modules can be connected for the entire system. Up to 4 modules of the FX5-40SSC-G, FX5-80SSC-G, and FX5-CCLGN-MS (master station) can be connected in total. The FX5-SF-MU4T5 and FX5-SF-8DI4 cannot be used simultaneously.
	FX5-CCLGN-MS	Only 1 module can be connected in the entire system for each station type. • Master station: 1 module • Local station: 1 module When 4 modules of the FX5-40SSC-G and FX5-80SSC-G are connected to the entire system, the FX5-CCLGN-MS (master station) cannot be connected.
	FX5-CCL-MS	Only 1 module can be connected in the entire system for each station type. • Master station: 1 module*1 • Intelligent device station: 1 module*2
	FX5-ENET	Only 1 module can be connected in the entire system.
	FX5-ENET/IP	
	FX5-CCLIEF	
	FX5-DP-M	
	FX5-OPC	
	FX5-ASL-M	Only 1 module can be connected in the entire system. Use together with the FX3U-128ASL-M is not possible.
FX5 expansion adapter	FX5-232ADP	Up to 2 modules can be connected for the entire system.
	FX5-485ADP	
	FX5-4A-ADP*3	
	FX5-4AD-ADP	Up to 4 modules can be connected for the entire system.
	FX5-4DA-ADP	
	FX5-4AD-PT-ADP	
FX5-4AD-TC-ADP*4		
FX5 safety extension module	FX5-SF-MU4T5	Only 1 module can be connected in the entire system. This module cannot be used together with the bus conversion module or FX3 extension module. The FX5-40SSC-G and FX5-80SSC-G cannot be used simultaneously. Locate the module on the rightmost side of the system configuration. However, this does not apply when the safety input extension module is connected.
	FX5-SF-8DI4	Up to 2 modules can be connected for the entire system. This module cannot be used together with the bus conversion module or FX3 extension module. The FX5-40SSC-G and FX5-80SSC-G cannot be used simultaneously. Connect the module just after FX5-SF-MU4T5, and locate it on the rightmost side of the system configuration.
FX3 intelligent function module	FX3U-4AD	Up to 6 modules can be connected for the entire system.
	FX3U-4DA	
	FX3U-1PG	
	FX3U-4LC	
	FX3U-128ASL-M	Only 1 module can be connected in the entire system. It cannot be used together with the FX5-ASL-M.
	FX3U-16CCL-M	Only 1 module can be connected in the entire system. When using the FX5-CCL-MS as the master station, it cannot be used together with the FX5-CCL-MS.
	FX3U-64CCL	Only 1 module can be connected in the entire system. When using the FX5-CCL-MS as the intelligent device station, it cannot be used together with the FX5-CCL-MS.
FX3U-2HC	Up to 2 modules can be connected for the entire system. Connect immediately after the bus conversion module.	

*1: When using the FX5-CCL-MS as the master station, it cannot be used together with the FX3U-16CCL-M.

*2: When using the FX5-CCL-MS as the intelligent device station, it cannot be used together with the FX3U-64CCL.

*3: Do not connect the FX5-4DA-ADP adjacent to both sides.

*4: Do not connect the FX5-4DA-ADP or FX5-4A-ADP adjacent to both sides.

Refer to the manual for details on each model.

Safety Extension Module

The safety extension module is designed to configure a safety control system with the FX5UJ/FX5U/FX5UC CPU module. A safety control system can be easily introduced by connecting the safety extension module, and general control and safety control can be performed only with this one system. The module has received the certification of the international safety standard (category 4, PL e, SIL3).

Safety main module

The safety extension module is designed to configure a safety control system with the FX5UJ/FX5U/FX5UCCPU module. A safety control system can be configured only by connecting the safety main module to the FX5UJ/FX5U/FX5UC CPU module.

Model	Specifications		Compatible CPU module		
			FX5UJ	FX5U	FX5UC
 FX5-SF-MU4T5	Total No. of points	8 points	○*1	○*1	○*1*2
	Number of safety inputs	4 points			
	Number of safety outputs	4 points			
	Maximum number of connectable modules	1 module			
	Safety integrity level (SIL)	SIL3 (IEC 61508)			
	Performance level (PL)	PL e (DIN EN ISO 13849-1)			
	Off delay time	0 / 0.5 / 1 / 1.5 / 2 / 2.5 / 3 / 3.5 / 4 / 5 s			
	Program for a safety control	9 types			

*1: Supported by FX5UJ CPU modules Ver. 1.010 or later. Supported by FX5U/FX5UC CPU module Ver. 1.200 or later.
 *2: Connection with FX5UC CPU module requires connector conversion module (FX5-CNV-IFC) or extension power supply module (FX5-C1PS-5V).

Safety input expansion module

The safety extension module is designed to configure a safety control system with the FX5UJ/FX5U/FX5UC CPU module. Safety input can be extended by connecting the safety input expansion module.

Model	Specifications		Compatible CPU module		
			FX5UJ	FX5U	FX5UC
 FX5-SF-8DI4	Total No. of points	8 points	○*1	○*1	○*1*2
	Number of safety inputs	8 points			
	Number of safety outputs	—			
	Maximum number of connectable modules	2 modules			
	Safety integrity level (SIL)	SIL3 (IEC 61508)			
	Performance level (PL)	PL e (DIN EN ISO 13849-1)			
	Off delay time	—*3			
	Program for a safety control	9 types			

*1: Supported by FX5UJ CPU modules Ver. 1.010 or later. Supported by FX5U/FX5UC CPU module Ver. 1.200 or later.
 *2: Connection with FX5UC CPU module requires connector conversion module (FX5-CNV-IFC) or extension power supply module (FX5-C1PS-5V).
 *3: The off-delay time is set on the safety main module.

FX5-SF-MU4T5 safety main module

◆ Features



- 1) Module for configuring a safety control system.
- 2) It can be connected directly to the FX5UJ/FX5U/FX5UC CPU module. An existing general control system can be extended to a safety control system only by installing the safety main module.
- 3) A sequence program for safety control is unnecessary. A safety control system can be configured only by selecting a built-in program (9 kinds).
- 4) If any error occurs on the safety control side, the error status can be easily checked on the monitor or the diagnosis screen of GX Works3, and troubleshooting can be easily performed.

◆ Safety precautions

FX5-SF-MU4T5 is jointly developed and manufactured by Mitsubishi Electric Corporation and SICK AG. The warranty for this module differs from that of other PLC products. For warranty and specification, refer to the manual.

- *1: For details regarding the general inputs, refer to the manual.
- *2: The minimum switch-off time is the minimum time takes until a switch-off condition is detected after a module is switched off.
- *3: A response time without any sensors. If a sensor is connected, the response time of the connected sensor is added to this value.
- *4: The time from when a muting condition is enabled (I2/I3 are turned ON) until a muting function is activated.
- *5: Indicates the maximum switch-off time when a muting error occurs.
- *6: A muting input (I2 or I3) keeps OFF for the specified period of time.
- *7: A time from when an ERROR LED starts flashing.
- *8: A cross-circuit detection is performed only in the module.
- *9: A response time without any sensors. If a sensor is connected, the response time of the connected sensor is added to this value.

◆ Specifications

Items		Specifications	
Safety integrity level		SIL3 (IEC 61508)/SILCL 3 (IEC 62061)	
Category		Category 4 (DIN EN ISO 13849-1)	
Performance level		PL e (DIN EN ISO 13849-1)	
PFHd		1.5×10^{-8}	
Tm (mission time)		20 years (EN ISO 13849-1)	
Safety inputs*1	Number of inputs	4 points	
	Input voltage (ON)	13 V DC or more (13 V DC to 30 V DC)	
	Input voltage (OFF)	5 V DC or less (-5 V DC to 5 V DC)	
	Input current (ON)	3 mA (2.4 mA to 3.8 mA)	
	Input current (OFF)	2.1 mA or less (-2.5 mA to 2.1 mA)	
	Input response time (filter delay)	2 ms	
	Minimum switch-off time*2*3 (I0/I1)	Program 1, 2, 4, 5, 6, and 9	24 ms
		Program 3.1, 7, and 8	4 ms
		Program 3.2	76 ms/24 ms
	Minimum switch-off time*2*3 (I2/I3)	Program 4, 5, and 6	24 ms
		Program 1, 2, 3, 7, 8, and 9	4 ms
	Power-up time		70 ms
	Synchronous time monitoring	Program 1 and 2	1500 ms
		Program 4 and 5	500 ms
	Muting ON*4	Program 3	61 ms
	Muting OFF	Program 3	61 ms (165 ms*5)
Muting gap suppression*6	Program 3	94 ms to 100 ms	
Reset time		106 ms	
Maximum teach-in time of the ENTER button*7		3 s	
Duration of actuation of a reset button (X0 and X1)		50 ms to 5 s	
Test outputs		For details, refer to the manual.	
Safety outputs	Number of outputs	4 points	
	Output method	Source output, short-circuit protection, cross-circuit detection*8	
	Output voltage	18.4 V DC to 30.0 V DC	
	Output current	2.0 A (@TA≤45°C) 1.5 A (@TA≤55°C)	
	Total current Isum	4.0 A (@TA≤45°C) 3.0 A (@TA≤55°C)	
	Leak current (in the switch OFF status)	1 mA or less	
	Response time*9 (I0/I1)	Program 1, 2, 4, 5, 6, and 9	29 ms
		Program 3.1, 7, and 8	9 ms
		Program 3.2	81 ms/29 ms
	Response time*9 (I2/I3)	Program 4, 5, and 6	29 ms
		Program 1, 2, 3, 7, 8, and 9	9 ms
Response time (XS0)		9 ms	
Off delay time		0 / 0.5 / 1 / 1.5 / 2 / 2.5 / 3 / 3.5 / 4 / 5 s	
Programs		0: Inactive 1: OR control (1) 2: OR control (2) 3: Muting control 4: Two-hand control (1) 5: Two-hand control (2) 6: AND control (1) 7: AND control (2) 8: Independent control 9: AND control (3)	
Power supply		5 V DC 200 mA, 24 V DC 5 mA (internal power supply) 24 V DC (+20%, -15%) 125 mA (external power supply)	
Compatible CPU module		FX5UJ: Ver. 1.010 or later FX5U, FX5UC: Ver. 1.200 or later Connection with FX5UC CPU module requires connector conversion module (FX5-CNV-IFC) or extension power supply module (FX5-C1PS-5V).	
Applicable engineering tool		FX5UJ: GX Works3 Ver. 1.075D or later FX5U, FX5UC: GX Works3 Ver. 1.060N or later	
Number of occupied I/O points		8 points (Either input or output is available for counting.)	
Number of connectable modules		FX5UJ: Up to 1 module FX5U: Up to 1 module FX5UC: Up to 1 module	
External dimensions W × H × D (mm)		50 × 90 × 102.2	
MASS (Weight): kg		Approx. 0.3	

FX5-SF-8DI4 safety input expansion module

◆ Features



- 1) Safety input can be extended on the configured safety control system.
- 2) A sequence program for safety control is unnecessary. A safety control system can be configured only by selecting a built-in program (9 kinds).
- 3) If any error occurs on the safety control side, the error status can be easily checked on the monitor or the diagnosis screen of GX Works3, and troubleshooting can be easily performed.

◆ Safety precautions

FX5-SF-8DI4 is jointly developed and manufactured by Mitsubishi Electric Corporation and SICK AG. The warranty for this module differs from that of other PLC products. For warranty and specification, refer to the manual.

◆ Specifications

Items		Specifications	
Safety integrity level		SIL3 (IEC 61508)/SILCL 3 (IEC 62061)	
Category		Category 4 (DIN EN ISO 13849-1)	
Performance level		PL e (DIN EN ISO 13849-1)	
PFHd		1.5×10^{-8}	
Tm (mission time)		20 years (EN ISO 13849-1)	
Safety inputs	Number of inputs	8 points	
	Input voltage (ON)	13 V DC or more (13 V DC to 30 V DC)	
	Input voltage (OFF)	5 V DC or less (-5 V DC to 5 V DC)	
	Input current (ON)	3 mA (2.4 mA to 3.8 mA)	
	Input current (OFF)	2.1 mA or less (-2.5 mA to 2.1 mA)	
	Minimum switch-off time	Program 1, 2, 3, 4, 5, and 8 Program 6 and 7	24 ms 4 ms
	Synchronous time monitoring	Program 3 and 5	1500 ms
Power-up time		70 ms	
Test outputs		For details, refer to the manual.	
Response time	Program 1, 2, 3, 4, 5, and 8	33 ms	
	Program 6 and 7	13 ms	
Programs		0: Inactive 1: AND link (single channel) 2: AND link (dual channel) (1) 3: AND link (dual channel) (2) 4: AND link (dual channel) (3) 5: AND link (dual channel) (4) 6: AND link (dual channel) (5) 7: OR link (dual channel) 8: Bypass 9: All paths batch connection	
Power supply		24 V DC (+20%, -15%) 125 mA (Internal power supply from the FX5-SF-MU4T5)	
Compatible CPU module		FX5UU: Ver. 1.010 or later FX5U, FX5UC: Ver. 1.200 or later Connection with FX5UC CPU module requires connector conversion module (FX5-CNV-IFC) or extension power supply module (FX5-C1PS-5V).	
Applicable engineering tool		FX5UU: GX Works3 Ver. 1.075D or later FX5U, FX5UC: GX Works3 Ver. 1.060N or later	
Number of occupied I/O points		0 points (no occupied points)	
Number of connectable modules		FX5UU: Up to 2 modules FX5U: Up to 2 modules FX5UC: Up to 2 modules	
External dimensions W × H × D (mm)		50 × 90 × 102.2	
MASS (Weight): kg		Approx. 0.25	

Example of built-in program

◇ Safety main module built-in program

For the details of the programs and wiring of the safety main module and safety extension module, refer to the manuals, quick start guide for safety extension module (L(NA)08708ENG) or safety extension module configuration guide (see page 22).

Program number	Outline	Logic diagram	Program number	Outline	Logic diagram
1	OR control (1)		6	AND control (1)	
2	OR control (2)		7	AND control (2)	
3	Muting control		8	Independent control	
4	Two-hand control (1)		9	AND control (3)	
5	Two-hand control (2)				

*: This is an off delay time. The factory default setting of the rotary switch is 0 second.

For the terms in the logic diagrams, refer to the following.

Left side of terminal arrangement		Right side of terminal arrangement	
Name	Description	Name	Description
I0	Safety input 0	Q0	Safety output 0
I1	Safety input 1	Q1	Safety output 1
I2	Safety input 2	Q2	Safety output 2
I3	Safety input 3	Q3	Safety output 3
AND	AND Operation	OR	OR Operation
N/C	An abbreviation for normally closed.	N/O	An abbreviation for normally open.

I/O Module



The I/O module is a product for extending inputs/outputs. Some products are powered.

Powered input/output modules

Powered input/output module is a powered input/output extension device.

Like with the CPU module, various I/O modules and intelligent function modules can be connected to the rear stage of extension module.

◇ List of powered input/output modules

Model	Total No. of points	No. of input/output points, Input/output type		Compatible CPU module			MASS (Weight): kg	External dimensions W × H × D (mm)			
		Input	Output	FX5UJ	FX5U	FX5UC					
AC power supply type 	FX5-32ER/ES	32 points	16 points	24 V DC (sink/source)	16 points	Relay	○	○	×	Approx. 0.65	150 × 90 × 83
	FX5-32ET/ES					Transistor (sink)					
	FX5-32ET/ESS					Transistor (source)					
DC power supply type 	FX5-32ER/DS	32 points	16 points	24 V DC (sink/source)	16 points	Relay	×	○	○*	Approx. 0.65	150 × 90 × 83
	FX5-32ET/DS					Transistor (sink)					
	FX5-32ET/DSS					Transistor (source)					

*: Connection with FX5UC requires connector conversion module (FX5-CNV-IFC).

Connection cable

The extension cable for connection to the right side of the front-stage device is offered as an accessory of each powered I/O module.

I/O module

Input modules/output modules receive the power from the CPU module, and extend input/output points. Each module can be offered as the extension cable type or extension connector type.

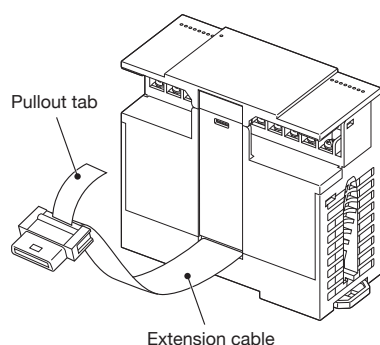

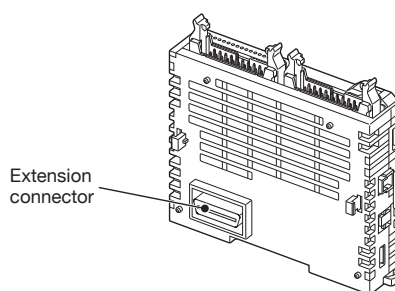

Extension cable type







Extension connector type

◇ List of input modules (extension cable type)

Model		Total No. of points	No. of input/output points, Input/output type				Compatible CPU module			MASS (Weight): kg	External dimensions W × H × D (mm)
			Input		Output		FX5UJ	FX5U	FX5UC		
	FX5-8EX/ES	8 points	8 points	24 V DC (sink/source)	—	—	○	○	○*	Approx. 0.2	40 × 90 × 83
	FX5-16EX/ES	16 points	16 points	24 V DC (sink/source)	—	—				Approx. 0.25	

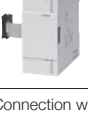

*: Connection with FX5UC CPU module requires connector conversion module (FX5-CNV-IFC) or extension power supply module (FX5-C1PS-5V).

◇ List of output modules (extension cable type)

Model		Total No. of points	No. of input/output points, Input/output type				Compatible CPU module			MASS (Weight): kg	External dimensions W × H × D (mm)
			Input		Output		FX5UJ	FX5U	FX5UC		
	FX5-8EYR/ES	8 points	—	—	8 points	Relay	○	○	○*	Approx. 0.2	40 × 90 × 83
	FX5-8EYT/ES	8 points			8 points	Transistor (sink)				Approx. 0.2	
	FX5-8EYT/ESS	8 points			8 points	Transistor (source)				Approx. 0.2	
	FX5-16EYR/ES	16 points			16 points	Relay				Approx. 0.25	
	FX5-16EYT/ES	16 points			16 points	Transistor (sink)				Approx. 0.25	
	FX5-16EYT/ESS	16 points			16 points	Transistor (source)				Approx. 0.25	

*: Connection with FX5UC CPU module requires connector conversion module (FX5-CNV-IFC) or extension power supply module (FX5-C1PS-5V).

◇ List of input/output modules (extension cable type)

Model		Total No. of points	No. of input/output points, Input/output type				Compatible CPU module			MASS (Weight): kg	External dimensions W × H × D (mm)
			Input		Output		FX5UJ	FX5U	FX5UC		
	FX5-16ER/ES	16 points	8 points	24 V DC (sink/source)	8 points	Relay	○	○	○*	Approx. 0.25	40 × 90 × 83
	FX5-16ET/ES					Transistor (sink)					
	FX5-16ET/ESS					Transistor (source)					

*: Connection with FX5UC CPU module requires connector conversion module (FX5-CNV-IFC) or extension power supply module (FX5-C1PS-5V).

◇ List of high-speed pulse input/output modules (extension cable type)

Model		Total No. of points	No. of input/output points, Input/output type				Compatible CPU module			MASS (Weight): kg	External dimensions W × H × D (mm)
			Input		Output		FX5UJ	FX5U	FX5UC		
	FX5-16ET/ES-H	16 points	8 points	24 V DC (sink/source)	8 points	Transistor (sink)	×	○	○*	Approx. 0.25	40 × 90 × 83
	FX5-16ET/ESS-H					Transistor (source)					

*: Connection with FX5UC CPU module requires connector conversion module (FX5-CNV-IFC) or extension power supply module (FX5-C1PS-5V).

Connection cable

Extension cable type input/output modules are equipped with the extension cable for connection to the right side of the front-stage device.

◇ List of input modules (extension connector type)

Model		Total No. of points	No. of input/output points, Input/output type				Compatible CPU module			MASS (Weight): kg	External dimensions W × H × D (mm)
			Input		Output		FX5UJ	FX5U	FX5UC		
	FX5-C16EX/D	16 points	16 points	24 V DC (sink)	-	-	○*	○*	○	Approx. 0.1	14.6 × 90 × 87
	FX5-C16EX/DS			24 V DC (sink/source)						Approx. 0.1	14.6 × 90 × 87
	FX5-C32EX/D	32 points	32 points	24 V DC (sink)	-	-	○*	○*	○	Approx. 0.15	20.1 × 90 × 87
	FX5-C32EX/DS			24 V DC (sink/source)						Approx. 0.15	20.1 × 90 × 87
	FX5-C32EX/DS-TS			Approx. 0.15						20.1 × 90 × 93.7	

*: Connection with FX5UJ/FX5U CPU module requires connector conversion module (FX5-CNV-IFC).

◇ List of output modules (extension connector type)

Model		Total No. of points	No. of input/output points, Input/output type				Compatible CPU module			MASS (Weight): kg	External dimensions W × H × D (mm)
			Input		Output		FX5UJ	FX5U	FX5UC		
	FX5-C16EYT/D	16 points	-	-	16 points	Transistor (sink)	○*	○*	○	Approx. 0.1	14.6 × 90 × 87
	FX5-C16EYT/DSS				Transistor (source)	Approx. 0.1				14.6 × 90 × 87	
	FX5-C16EYR/D-TS				Relay	Approx. 0.2				30.7 × 90 × 93.7	
	FX5-C32EYT/D	32 points	-	-	32 points	Transistor (sink)	○*	○*	○	Approx. 0.15	20.1 × 90 × 87
	FX5-C32EYT/DSS				Transistor (source)	Approx. 0.15				20.1 × 90 × 87	
	FX5-C32EYT/D-TS				Transistor (sink)	Approx. 0.15				20.1 × 90 × 93.7	
	FX5-C32EYT/DSS-TS				Transistor (source)	Approx. 0.15				20.1 × 90 × 93.7	

*: Connection with FX5UJ/FX5U CPU module requires connector conversion module (FX5-CNV-IFC).

◇ List of I/O modules (extension connector type)

Model		Total No. of points	No. of input/output points, Input/output type				Compatible CPU module			MASS (Weight): kg	External dimensions W × H × D (mm)
			Input		Output		FX5UJ	FX5U	FX5UC		
	FX5-C32ET/D	32 points	16 points	24 V DC (sink)	16 points	Transistor (sink)	○*	○*	○	Approx. 0.15	20.1 × 90 × 87
	FX5-C32ET/DSS			Transistor (source)		Approx. 0.15				20.1 × 90 × 87	
	FX5-C32ET/DS-TS			24 V DC (sink/source)		Transistor (sink)				Approx. 0.15	20.1 × 90 × 93.7
	FX5-C32ET/DSS-TS			Transistor (source)		Approx. 0.15				20.1 × 90 × 93.7	

*: Connection with FX5UJ/FX5U CPU module requires connector conversion module (FX5-CNV-IFC).

Examples of combinations of FX5UJ inputs/outputs

The table below shows examples of combinations of FX5UJ extension modules. The contents of combinations can be described based on the number of input points.

- In addition to the combinations shown below, various combinations can be made by changing selected I/O modules and extension modules

Number of I/O points		CPU module		Input/output module		Powered input/output module FX5-32E		Input/output module		I/O total (Total occupied)	
Input	Output	Module model	Input	Output	Input	Output	Input	Output	Input	Output	
14	10	24M	14	10							24 (32)
14	18	24M	14	10	0	8					32 (40)
14	26	24M	14	10	0	16					40 (48)
14	34	24M	14	10	0	24					48 (56)
14	42	24M	14	10	0	32					56 (64)
14	50	24M	14	10	0	40					64 (72)
14	58	24M	14	10	0	48					72 (80)
14	74	24M	14	10	0	64					88 (96)
24	16	40M	24	16							40
24	24	40M	24	16	0	8					48
24	32	40M	24	16	0	16					56
24	40	40M	24	16	0	24					64
24	48	40M	24	16	0	32					72
24	56	40M	24	16	0	40					80
24	64	40M	24	16	0	48					88
24	80	40M	24	16	0	64					104
30	10	24M	14	10	16	0					40 (48)
30	26	24M	14	10	0	0	16	16			56 (64)
30	26	24M	14	10	16	16					56 (64)
30	34	24M	14	10	0	8	16	16			64 (72)
30	42	24M	14	10	0	16	16	16			72 (80)
30	50	24M	14	10	0	24	16	16			80 (88)
30	58	24M	14	10	0	32	16	16			88 (96)
30	66	24M	14	10	0	40	16	16			96 (104)
30	74	24M	14	10	0	48	16	16			104 (112)
30	90	24M	14	10	0	64	16	16			120 (128)
36	24	60M	36	24							60 (64)
36	32	60M	36	24	0	8					68 (72)
36	40	60M	36	24	0	16					76 (80)
36	48	60M	36	24	0	24					84 (88)
36	56	60M	36	24	40	32					92 (96)
36	64	60M	36	24	0	40					100 (104)
36	72	60M	36	24	0	48					108 (112)
36	88	60M	36	24	0	64					124 (128)

Number of I/O points		CPU module		Input/output module		Powered input/output module FX5-32E		Input/output module		I/O total (Total occupied)	
Input	Output	Module model	Input	Output	Input	Output	Input	Output	Input	Output	
40	16	40M	24	16	16	0					56
40	32	40M	24	16	0	0	16	16			72
40	32	40M	24	16	16	16					72
40	40	40M	24	16	0	8	16	16			80
40	48	40M	24	16	0	16	16	16			88
40	48	40M	24	16	16	32					88
40	56	40M	24	16	0	24	16	16			96
40	64	40M	24	16	0	32	16	16			104
40	72	40M	24	16	0	40	16	16			112
40	80	40M	24	16	0	48	16	16			120
40	96	40M	24	16	0	64	16	16			136
46	10	24M	14	10	32	0					56 (64)
46	26	24M	14	10	16	0	16	16			72 (80)
46	42	24M	14	10	0	0	16	16	16	16	88 (96)
46	42	24M	14	10	16	16	16	16			88 (96)
46	50	24M	14	10	0	8	16	16	16	16	96 (104)
46	58	24M	14	10	0	16	16	16	16	16	104 (112)
46	66	24M	14	10	0	24	16	16	16	16	112 (120)
46	74	24M	14	10	0	32	16	16	16	16	120 (128)
46	82	24M	14	10	0	40	16	16	16	16	128 (136)
46	90	24M	14	10	0	48	16	16	16	16	136 (144)
46	106	24M	14	10	0	64	16	16	16	16	152 (160)
52	24	60M	36	24	16	0					76 (80)
52	40	60M	36	24	0	0	16	16			92 (96)
52	40	60M	36	24	16	16					92 (96)
52	48	60M	36	24	0	8	16	16			100 (104)
52	56	60M	36	24	0	16	16	16			108 (112)
52	56	60M	36	24	16	32					108 (112)
52	64	60M	36	24	0	24	16	16			116 (120)
52	72	60M	36	24	0	32	16	16			124 (128)
52	80	60M	36	24	0	40	16	16			132 (136)
52	88	60M	36	24	0	48	16	16			140 (144)
52	104	60M	36	24	0	64	16	16			156 (160)

Number of I/O points		CPU module		Input/output module		Powered input/output module FX5-32E		Input/output module		I/O total (Total occupied)	
Input	Output	Module model	Input	Output	Input	Output	Input	Output	Input	Output	
56	16	40M	24	16	32	0					72
56	32	40M	24	16	16	0	16	16			88
56	32	40M	24	16	32	16					88
56	40	40M	24	16	32	24					96
56	48	40M	24	16	0	0	16	16	16	16	104
56	48	40M	24	16	16	16	16	16			104
56	56	40M	24	16	0	8	16	16	16	16	112
56	64	40M	24	16	0	16	16	16	16	16	120
56	64	40M	24	16	16	32	16	16			120
56	72	40M	24	16	0	24	16	16	16	16	128
56	80	40M	24	16	0	32	16	16	16	16	136
56	88	40M	24	16	0	40	16	16	16	16	144
56	96	40M	24	16	0	48	16	16	16	16	152
56	112	40M	24	16	0	64	16	16	16	16	168
68	24	60M	36	24	32	0					92 (96)
68	40	60M	36	24	16	0	16	16			108 (112)
68	40	60M	36	24	32	16					108 (112)
68	56	60M	36	24	0	0	16	16	16	16	124 (128)
68	56	60M	36	24	16	16	16	16			124 (128)
68	64	60M	36	24	0	8	16	16	16	16	132 (136)
68	72	60M	36	24	0	16	16	16	16	16	140 (144)
68	72	60M	36	24	16	32	16	16			140 (144)
68	80	60M	36	24	0	24	16	16	16	16	148 (152)
68	88	60M	36	24	0	32	16	16	16	16	156 (160)
68	96	60M	36	24	0	40	16	16	16	16	164 (168)
68	104	60M	36	24	0	48	16	16	16	16	172 (176)
68	120	60M	36	24	0	64	16	16	16	16	188 (192)
72	16	40M	24	16	48	0					88
72	32	40M	24	16	32	0	16	16			104
72	32	40M	24	16	48	16					104
72	48	40M	24	16	32	16	16	16			120
72	56	40M	24	16	32	24	16	16			128
72	64	40M	24	16	16	16	16	16	16	16	136
84	24	60M	36	24	48	0					108 (112)
84	40	60M	36	24	32	0	16	16			124 (128)
84	40	60M	36	24	48	16					124 (128)
84	56	60M	36	24	32	16	16	16			140 (144)

Number of I/O points		CPU module		Input/output module		Powered input/output module FX5-32E		Input/output module		I/O total (Total occupied)	
Input	Output	Module model	Input	Output	Input	Output	Input	Output	Input	Output	
88	16	40M	24	16	64	0					104
88	32	40M	24	16	48	0	16	16			120
88	40	40M	24	16	16	0	16	16	32	8	128
88	48	40M	24	16	48	16	16	16			136
88	56	40M	24	16	16	16	16	16	32	8	144
88	72	40M	24	16	16	32	16	16	32	8	160
100	24	60M	36	24	64	0					124 (128)
100	40	60M	36	24	48	0	16	16			140 (144)
100	48	60M	36	24	16	0	16	16	32	8	148 (152)
100	56	60M	36	24	48	16	16	16			156 (160)
100	64	60M	36	24	16	16	16	16	32	8	164 (168)
100	80	60M	36	24	16	32	16	16	32	8	180 (184)
104	32	40M	24	16	64	0	16	16			136
104	40	40M	24	16	32	0	16	16	32	8	144
104	56	40M	24	16	32	16	16	16	32	8	160
104	64	40M	24	16	32	24	16	16	32	8	168
116	40	60M	36	24	64	0	16	16			156 (160)
116	48	60M	36	24	32	0	16	16	32	8	164 (168)
116	64	60M	36	24	32	16	16	16	32	8	180 (184)
120	40	40M	24	16	48	0	16	16	32	8	160
120	56	40M	24	16	48	16	16	16	32	8	176
132	48	60M	36	24	48	0	16	16	32	8	180 (184)
132	64	60M	36	24	48	16	16	16	32	8	196 (200)
148	48	60M	36	24	64	0	16	16	32	8	196 (200)

Examples of combinations of FX5U inputs/outputs

The table below shows examples of combinations of FX5U extension modules. The contents of combinations can be described based on the number of input points.

- In addition to the combinations shown below, various combinations can be made by changing selected I/O modules and extension modules.

Number of I/O points		CPU module		Input/output module		Powered input/output module FX5-32E		Input/output module		I/O total	
Input	Output	Module model	Input	Output	Input	Output	Input	Output	Input		Output
16	16	32M	16	16							32
16	24	32M	16	16	0	8					40
16	32	32M	16	16	0	16					48
16	40	32M	16	16	0	24					56
16	48	32M	16	16	0	32					64
16	64	32M	16	16	0	48					80
24	16	32M	16	16	8	0					40
24	24	32M	16	16	8	8					48
24	32	32M	16	16	8	16					56
24	40	32M	16	16	8	24					64
32	16	32M	16	16	16	0					48
32	32	32M	16	16	16	16					64
32	32	32M	16	16	0	0	16	16			64
32	32	64M	32	32							64
32	40	32M	16	16	0	8	16	16			72
32	40	64M	32	32	0	8					72
32	48	32M	16	16	0	16	16	16			80
32	48	64M	32	32	0	16					80
32	56	32M	16	16	0	24	16	16			88
32	56	64M	32	32	0	24					88
32	64	64M	32	32	0	32					96
32	80	64M	32	32	0	48					112
32	80	64M	32	32	0	48					112
40	16	32M	16	16	24	0					56
40	24	32M	16	16	24	8					64
40	32	32M	16	16	8	0	16	16			72
40	40	32M	16	16	8	8	16	16			80
40	40	80M	40	40							80
40	56	80M	40	40	0	16					96
40	72	80M	40	40	0	32					112
40	88	80M	40	40	0	48					128
48	16	32M	16	16	32	0					64
48	32	32M	16	16	16	0	16	16			80
48	32	64M	32	32	16	0					80
48	48	32M	16	16	16	16	16	16			96
48	48	64M	32	32	16	16					96
48	48	64M	32	32	0	0	16	16			96
48	64	64M	32	32	16	32					112
48	64	64M	32	32	0	16	16	16			112
48	80	64M	32	32	0	32	16	16			128
48	96	64M	32	32	0	48	16	16			144

Number of I/O points		CPU module		Input/output module		Powered input/output module FX5-32E		Input/output module		I/O total	
Input	Output	Module model	Input	Output	Input	Output	Input	Output	Input		Output
56	32	32M	16	16	24	0	16	16			88
56	40	32M	16	16	24	8	16	16			96
56	40	80M	40	40	16	0					96
56	56	80M	40	40	16	16					112
56	56	80M	40	40	0	0	16	16			112
56	72	80M	40	40	16	32					128
56	72	80M	40	40	0	16	16	16			128
56	88	80M	40	40	0	32	16	16			144
56	104	80M	40	40	0	48	16	16			160
64	32	32M	16	16	32	0	16	16			96
64	32	64M	32	32	32	0					96
64	48	32M	16	16	0	0	16	16	32	16	112
64	48	64M	32	32	16	0	16	16			112
64	48	64M	32	32	32	16					112
64	56	32M	16	16	0	8	16	16	32	16	120
64	56	64M	32	32	32	24					120
64	64	32M	16	16	0	16	16	16	32	16	128
64	64	64M	32	32	16	16	16	16			128
64	72	32M	16	16	0	24	16	16	32	16	136
64	80	64M	32	32	16	32	16	16			144
72	40	80M	40	40	32	0					112
72	48	32M	16	16	8	0	16	16	32	16	120
72	56	32M	16	16	8	8	16	16	32	16	128
72	56	80M	40	40	32	16					128
72	56	80M	40	40	16	0	16	16			128
72	64	80M	40	40	32	24					136
72	72	80M	40	40	16	16	16	16			144
72	88	80M	40	40	16	32	16	16			160
80	32	64M	32	32	48	0					112
80	48	32M	16	16	16	0	16	16	32	16	128
80	48	64M	32	32	48	16					128
80	48	64M	32	32	32	0	16	16			128
80	64	32M	16	16	16	16	16	16	32	16	144
80	64	64M	32	32	32	16	16	16			144
80	72	64M	32	32	32	24	16	16			152
80	80	64M	32	32	0	16	16	16	32	16	160
80	96	64M	32	32	0	32	16	16	32	16	176
80	112	64M	32	32	0	48	16	16	32	16	192

Number of I/O points		CPU module		Input/output module		Powered input/output module FX5-32E		Input/output module		I/O total	
Input	Output	Module model	Input	Output	Input	Output	Input	Output	Input		Output
88	40	80M	40	40	48	0					128
88	48	32M	16	16	24	0	16	16	32	16	136
88	56	32M	16	16	24	8	16	16	32	16	144
88	56	80M	40	40	48	16					144
88	56	80M	40	40	32	0	16	16			144
88	64	32M	16	16	24	8	16	16	32	24	152
88	72	80M	40	40	32	16	16	16			160
88	80	80M	40	40	32	24	16	16			168
88	88	80M	40	40	0	16	16	16	32	16	176
88	104	80M	40	40	0	32	16	16	32	16	192
88	120	80M	40	40	0	48	16	16	32	16	208
96	32	64M	32	32	64	0					128
96	48	32M	16	16	32	0	16	16	32	16	144
96	48	64M	32	32	48	0	16	16			144
96	56	32M	16	16	32	0	16	16	32	24	152
96	64	64M	32	32	48	16	16	16			160
96	64	64M	32	32	16	0	16	16	32	16	160
96	80	64M	32	32	16	16	16	16	32	16	176
96	96	64M	32	32	16	32	16	16	32	16	192
104	40	80M	40	40	64	0					144
104	56	80M	40	40	48	0	16	16			160
104	72	80M	40	40	48	16	16	16			176
104	72	80M	40	40	16	0	16	16	32	16	176
104	88	80M	40	40	16	16	16	16	32	16	192
104	104	80M	40	40	16	32	16	16	32	16	208
112	48	64M	32	32	64	0	16	16			160
112	64	64M	32	32	32	0	16	16	32	16	176
112	80	64M	32	32	32	16	16	16	32	16	192
112	88	64M	32	32	32	24	16	16	32	16	200
120	56	80M	40	40	64	0	16	16			176
120	72	80M	40	40	32	0	16	16	32	16	192
120	88	80M	40	40	32	16	16	16	32	16	208
120	96	80M	40	40	32	24	16	16	32	16	216
128	64	64M	32	32	48	0	16	16	32	16	192
128	80	64M	32	32	48	16	16	16	32	16	208
128	88	64M	32	32	48	16	16	16	32	24	216
136	72	80M	40	40	48	0	16	16	32	16	208
136	88	80M	40	40	48	16	16	16	32	16	224
136	96	80M	40	40	48	16	16	16	32	24	232

Number of I/O points		CPU module		Input/output module		Powered input/output module FX5-32E		Input/output module		I/O total	
Input	Output	Module model	Input	Output	Input	Output	Input	Output	Input		Output
144	64	64M	32	32	64	0	16	16	32	16	208
144	72	64M	32	32	64	0	16	16	32	24	216
144	80	64M	32	32	64	0	16	16	32	32	224
152	72	80M	40	40	64	0	16	16	32	16	224
152	80	80M	40	40	64	0	16	16	32	24	232

Examples of combinations of FX5UC inputs/outputs

The table below shows examples of combinations of FX5UC extension modules. The contents of combinations can be described based on the number of input points.

- In addition to the combinations shown below, various combinations can be made by changing selected I/O modules and extension modules.

Number of I/O points		CPU module			Input/output module		Connector conversion module	Input/output module		I/O total
Input	Output	Module model	Input	Output	Input	Output		Input	Output	
16	16	32M	16	16	0	0				32
16	24	32M	16	16	0	0	●		8	40
16	32	32M	16	16	0	16				48
16	48	32M	16	16	0	32				64
24	16	32M	16	16	0	0	●	8		40
24	48	32M	16	16	0	32	●	8		72
24	64	32M	16	16	0	48	●	8		88
24	80	32M	16	16	0	64	●	8		104
32	16	32M	16	16	16	0				48
32	32	32M	16	16	16	16				64
32	32	64M	32	32	0	0				64
32	48	32M	16	16	16	32				80
32	48	64M	32	32	0	16				80
32	64	64M	32	32	0	32				96
32	72	32M	16	16	16	48	●		8	104
32	80	64M	32	32	0	48				112
40	16	32M	16	16	16	0	●	8		56
40	32	32M	16	16	16	16	●	8		72
40	32	64M	32	32	0	0	●	8		72
40	48	32M	16	16	16	32	●	8		88
40	64	64M	32	32	0	32	●	8		104
48	16	32M	16	16	32	0				64
48	32	64M	32	32	16	0				80
48	32	32M	16	16	32	16				80
48	48	32M	16	16	32	32				96
48	48	64M	32	32	16	16				96
48	48	96M	48	48	0	0				96
48	64	96M	48	48	0	16				112
48	64	64M	32	32	16	32				112
48	80	96M	48	48	0	32				128
56	32	32M	16	16	32	16	●	8		88
56	48	32M	16	16	32	32	●	8		104
56	48	64M	32	32	16	16	●	8		104
56	48	96M	48	48	0	0	●	8		104
56	64	32M	16	16	32	48	●	8		120
56	64	64M	32	32	16	32	●	8		120
56	64	96M	48	48	0	16	●	8		120
56	80	64M	32	32	16	48	●	8		136
56	96	96M	48	48	0	48	●	8		152
64	32	32M	16	16	48	16				96
64	48	64M	32	32	32	16				112
64	64	32M	16	16	48	48				128
64	64	96M	48	48	16	16				128
64	80	64M	32	32	32	48				144
64	96	96M	48	48	16	48				160

Number of I/O points		CPU module			Input/output module		Connector conversion module	Input/output module		I/O total
Input	Output	Module model	Input	Output	Input	Output		Input	Output	
72	32	32M	16	16	48	16	●	8		104
72	48	64M	32	32	32	16	●	8		120
72	64	32M	16	16	48	48	●	8		136
72	64	96M	48	48	16	16	●	8		136
72	64	64M	32	32	32	32	●	8		136
72	80	32M	16	16	48	64	●	8		152
72	80	64M	32	32	32	48	●	8		152
72	96	96M	48	48	16	48	●	8		168
80	32	64M	32	32	48	0				112
80	48	64M	32	32	48	16				128
80	48	32M	16	16	64	32				128
80	64	32M	16	16	64	48				144
80	64	96M	48	48	32	16				144
80	80	64M	32	32	48	48				160
80	80	32M	16	16	64	64				160
80	96	64M	32	32	48	64				176
80	96	96M	48	48	32	48				176
88	48	32M	16	16	64	32	●	8		136
88	48	64M	32	32	48	16	●	8		136
88	64	96M	48	48	32	16	●	8		152
88	64	32M	16	16	64	48	●	8		152
88	80	64M	32	32	48	48	●	8		168
88	80	96M	48	48	32	32	●	8		168
88	96	64M	32	32	48	64	●	8		184
88	112	64M	32	32	48	80	●	8		200
88	112	96M	48	48	32	64	●	8		200
88	128	96M	48	48	32	80	●	8		216
96	32	64M	32	32	64	0				128
96	48	96M	48	48	48	0				144
96	48	32M	16	16	80	32				144
96	64	32M	16	16	80	48				160
96	80	64M	32	32	64	48				176
96	96	32M	16	16	80	80				192
96	112	64M	32	32	64	80				208
96	112	96M	48	48	48	64				208
96	128	96M	48	48	48	80				224
96	144	96M	48	48	48	96				240
104	32	32M	16	16	80	16	●	8		136
104	48	96M	48	48	48	0	●	8		152
104	48	32M	16	16	80	32	●	8		152
104	48	64M	32	32	64	16	●	8		152
104	64	32M	16	16	80	48	●	8		168
104	64	64M	32	32	64	32	●	8		168
104	96	64M	32	32	64	64	●	8		200
104	112	96M	48	48	48	64	●	8		216
104	112	64M	32	32	64	80	●	8		216
104	128	96M	48	48	48	80	●	8		232

Number of I/O points		CPU module			Input/output module		Connector conversion module	Input/output module		I/O total
Input	Output	Module model	Input	Output	Input	Output		Input	Output	
112	64	64M	32	32	80	32				176
112	80	96M	48	48	64	32				192
112	96	32M	16	16	96	80				208
112	112	64M	32	32	80	80				224
112	112	96M	48	48	64	64				224
112	128	32M	16	16	96	112				240
112	128	64M	32	32	80	96				240
112	144	96M	48	48	64	96				256
120	64	32M	16	16	96	48	●	8		184
120	80	64M	32	32	80	48	●	8		200
120	96	96M	48	48	64	48	●	8		216
120	112	32M	16	16	96	96	●	8		232
120	112	64M	32	32	80	80	●	8		232
120	128	96M	48	48	64	80	●	8		248
120	128	64M	32	32	80	96	●	8		248
120	136	96M	48	48	64	80	●	8	8	256
128	64	32M	16	16	112	48				192
128	96	96M	48	48	80	48				224
128	96	32M	16	16	112	80				224
128	96	64M	32	32	96	64				224
128	112	96M	48	48	80	64				240
128	112	64M	32	32	96	80				240
128	128	96M	48	48	80	80				256
136	48	32M	16	16	112	32	●	8		184
136	80	64M	32	32	96	48	●	8		216
136	96	96M	48	48	80	48	●	8		232
136	96	64M	32	32	96	64	●	8		232
136	112	64M	32	32	96	80	●	8		248
136	120	96M	48	48	80	64	●	8	8	256
144	64	32M	16	16	128	48				208
144	80	64M	32	32	112	48				224
144	96	96M	48	48	96	48				240
144	112	64M	32	32	112	80				256
144	112	96M	48	48	96	64				256
152	64	32M	16	16	128	48	●	8		216
152	64	64M	32	32	112	32	●	8		216
152	96	96M	48	48	96	48	●	8		248
152	96	64M	32	32	112	64	●	8		248
152	104	96M	48	48	96	48	●	8	8	256
160	64	64M	32	32	128	32				224
160	80	96M	48	48	112	32				240
160	96	64M	32	32	128	64				256
160	96	96M	48	48	112	48				256
168	64	64M	32	32	128	32	●	8		232
168	80	96M	48	48	112	32	●	8		248
168	80	64M	32	32	128	48	●	8		248
168	88	96M	48	48	112	32	●	8	8	256

Number of I/O points		CPU module			Input/output module		Connector conversion module	Input/output module		I/O total
Input	Output	Module model	Input	Output	Input	Output		Input	Output	
176	64	64M	32	32	144	32				240
176	64	96M	48	48	128	16				240
176	80	64M	32	32	144	48				256
184	64	96M	48	48	128	16	●	8		248
184	64	64M	32	32	144	32	●	8		248
184	72	96M	48	48	128	16	●	8	8	256
192	48	64M	32	32	160	16				240
192	56	96M	48	48	144	0	●		8	248
192	64	96M	48	48	144	16				256
200	32	64M	32	32	160	0	●	8		232
200	48	96M	48	48	144	0	●	8		248
200	56	96M	48	48	144	0	●	8	8	256
208	48	96M	48	48	160	0				256

I/O Module

memo

Input/Output Devices for Voltage and Current

Analog input/output devices can be used to input and output analog amount of voltage, current, etc.

Analog control essential for FA control can easily be implemented by the PLC.

(For supporting micro voltage input of 0 to 10 mV DC, 0 to 100 mV DC, refer to FX5-4LC for "Input device for temperature sensor".)

List of analog input/output devices

◇ Analog input/output expansion adapter

Model (Number of channels)	Input specifications			Isolation method	Compatible CPU module			Analog input points
	Item	Input current	Input voltage		FX5UJ	FX5U	FX5UC	
FX5-4A-ADP (Input: 2 ch/ Output: 2 ch) 	Input range	-20 to +20 mA DC (Input resistance 250 Ω)	-10 to +10 V DC (Input resistance 1 MΩ)	Between input terminal and PLC: Photocoupler Between input channels: Non-isolation				2 points (2 ch)
	Resolution	1.25 μA (0 to 20 mA) 1.25 μA (4 to 20 mA) 2.5 μA (-20 to +20 mA)	625 μV (0 to 10 V) 312.5 μV (0 to 5 V) 312.5 μV (1 to 5 V) 1250 μV (-10 to +10 V)					
	Output specifications			Isolation method	○*1	○*2	○*2	Analog output points
	Items	Output current	Output voltage					
Output range	0 to 20 mA DC (External load resistance value 0 to 500 Ω)	-10 to +10 V DC (External load resistance value 1 kΩ to 1 MΩ)	Between output terminal and PLC: Photocoupler Between output channels: Non-isolation				2 points (2 ch)	
Resolution	1.25 μA (0 to 20 mA) 1 μA (4 to 20 mA)	625 μV (0 to 10 V) 312.5 μV (0 to 5 V) 250 μV (1 to 5 V) 1250 μV (-10 to +10 V)						

*1: Supported by FX5UJ CPU modules Ver. 1.010 or later.

*2: Supported by FX5U/FX5UC CPU module Ver. 1.240 or later.

◇ Analog input expansion adapter (A/D conversion)



Model (Number of channels)	Input specifications			Isolation method	Compatible CPU module			Analog input points
	Item	Input current	Input voltage		FX5UJ	FX5U	FX5UC	
FX5-4AD-ADP (4 ch) 	Input range	-20 to +20 mA DC (Input resistance 250 Ω)	-10 to +10 V DC (Input resistance 1 MΩ)	Between input terminal and PLC: Photocoupler Between input channels: Non-isolation	○	○	○	4 points (4 ch)
	Resolution	1.25 μA (0 to 20 mA) 1.25 μA (4 to 20 mA) 2.5 μA (-20 to +20 mA)	625 μV (0 to 10 V) 312.5 μV (0 to 5 V) 312.5 μV (1 to 5 V) 1250 μV (-10 to +10 V)					

◇ Analog output expansion adapter (D/A conversion)

Model (Number of channels)	Output specifications			Isolation method	Compatible CPU module			Analog output points
	Items	Output current	Output voltage		FX5UJ	FX5U	FX5UC	
FX5-4DA-ADP (4 ch) 	Output range	0 to 20 mA DC (External load resistance value 0 to 500 Ω)	-10 to +10 V DC (External load resistance value 1 kΩ to 1 MΩ)	Between output terminal and PLC: Photocoupler Between output channels: Non-isolation	○	○	○	4 points (4 ch)
	Resolution	1.25 μA (0 to 20 mA) 1 μA (4 to 20 mA)	625 μV (0 to 10 V) 312.5 μV (0 to 5 V) 250 μV (1 to 5 V) 1250 μV (-10 to +10 V)					

Input/Output Devices for Voltage and Current

◇ Analog input module (A/D conversion)



Model (Number of channels)	Input specifications			Isolation method	Compatible CPU module			Analog input points
	Items	Input current	Input voltage		FX5UJ	FX5U	FX5UC	
FX5-4AD (4 ch) 	Input range	-20 to +20 mA DC (Input resistance 250 Ω)	-10 to +10 V DC (Input resistance 400 kΩ or more)	Between input terminal and PLC: Photocoupler Between input terminal channels: Non-isolation	○	○	○*2	4 points (4 ch)
	Resolution	625 nA (0 to 20 mA) 500 nA (4 to 20 mA) 625 nA (-20 to +20 mA) 500 nA*1 (User range setting)	312.5 μV (0 to 10 V) 156.25 μV (0 to 5 V) 125 μV (1 to 5 V) 312.5 μV (-10 to +10 V) 125 μV*1 (User range setting)					
FX5-8AD (8 ch) 	Input range	-20 to +20 mA DC (Input resistance 250 Ω)	-10 to +10 V DC (Input resistance 1 MΩ)	Between input terminal and PLC: Photocoupler Between input terminal channels: Non-isolation	○	○	○*2	8 points (8 ch)
	Resolution	625 nA (0 to 20 mA) 500 nA (4 to 20 mA) 625 nA (-20 to +20 mA)	312.5 μV (0 to 10 V) 156.25 μV (0 to 5 V) 125 μV (1 to 5 V) 312.5 μV (-10 to +10 V)					
FX3U-4AD (4 ch) 	Input range	-20 to +20 mA DC, 4 to 20 mA DC (Input resistance 250 Ω)	-10 to +10 V DC (Input resistance 200 kΩ)	Between input terminal and PLC: Photocoupler Between input channels: Non-isolation	×	○*3	○*3	4 points (4 ch)
	Resolution	1.25 μA (-20 to +20 mA)	0.32 mV (-10 to +10 V)					

*1: Maximum resolution in the user range setting.

*2: Connection with FX5UC CPU module requires connector conversion module (FX5-CNV-IFC) or extension power supply module (FX5-C1PS-5V).

*3: Connection with FX5U/FX5UC CPU module requires bus conversion module (FX5-CNV-BUS or FX5-CNV-BUSC).

◇ Analog output module (D/A conversion)

Model (Number of channels)	Output specifications			Isolation method	Compatible CPU module			Analog output points
	Items	Output current	Output voltage		FX5UJ	FX5U	FX5UC	
FX5-4DA (4 ch) 	Output range	0 to 20 mA DC (External load resistance value 0 to 500 Ω)	-10 to +10 V DC (External load resistance value 1 kΩ to 1 MΩ)	Between output terminal and PLC: Photocoupler Between output channels: Non-isolation	○	○	○*2	4 points (4 ch)
	Resolution	625 nA (0 to 20 mA) 500 nA (4 to 20 mA) 500 nA*1 (User range setting)	312.5 μV (0 to 10 V) 156.25 μV (0 to 5 V) 125 μV (1 to 5 V) 312.5 μV (-10 to +10 V) 312.5 μV*1 (User range setting)					
FX3U-4DA (4 ch) 	Output range	0 to 20 mA DC, 4 to 20 mA DC (External load resistance value 500 Ω or less)	-10 to +10 V DC (external load resistance value 1 kΩ to 1 MΩ)	Between output terminal and PLC: Photocoupler Between output channels: Non-isolation	×	○*3	○*3	4 points (4 ch)
	Resolution	0.63 μA (0 to 20 mA)	0.32 mV (-10 to +10 V)					

*1: Maximum resolution in the user range setting.

*2: Connection with FX5UC CPU module requires connector conversion module (FX5-CNV-IFC) or extension power supply module (FX5-C1PS-5V).

*3: Connection with FX5U/FX5UC CPU module requires bus conversion module (FX5-CNV-BUS or FX5-CNV-BUSC).

◇ FX5U CPU module

Built-in analog input

Model (Number of channels)	Input specifications		Isolation method
	Items	Input voltage	
FX5U CPU module (2 ch) 	Input range	0 to 10 V DC (Input resistance 115.7 kΩ)	Between analog input circuit and PLC circuit: Non-isolation Between input channels: Non-isolation
	Resolution	2.5 mV	

Built-in analog output

Model (Number of channels)	Output specifications		Isolation method
	Items	Output voltage	
FX5U CPU module (1 ch) 	Output range	0 to 10 V DC (External load resistance value 2 kΩ to 1 MΩ)	Between analog input circuit and PLC circuit: Non-isolation
	Resolution	2.5 mV	

FX5-4A-ADP analog input/output expansion adapter

◆ Features

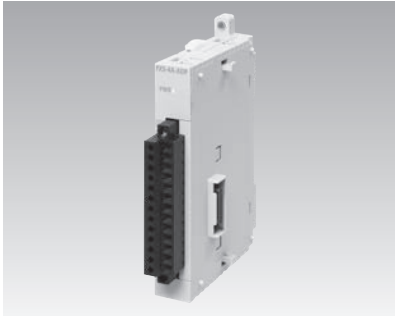

- 1) Expansion adapter for adding 2-channel analog input and 2-channel analog output.
- 2) High-precision input/analog output adapter with resolution of 14 bits binary.
- 3) 2-channel analog input (voltage input: -10 to +10 V DC or current input: -20 to +20 mA DC) and 2-channel analog output (voltage output: -10 to +10 V DC or current output: 0 to 20 mA DC) are allowed.
- 4) Voltage or current input can be specified for each channel.
- 5) Data can be transferred programless (no dedicated instructions).

◆ Specifications

Items		Specifications			
Analog input	Analog input points	2 points (2 channels)			
	Analog input voltage	-10 to +10 V DC (input resistance 1 MΩ)			
	Analog input current	-20 to +20 mA DC (input resistance 250 Ω)			
	Digital output value	14-bit binary value			
	Input characteristics, resolution*1	Voltage	Analog input range	Digital output value	Resolution
			0 to 10 V	0 to 16000	625 μV
		0 to 5 V	0 to 16000	312.5 μV	
		1 to 5 V	0 to 12800	312.5 μV	
		-10 to +10 V	-8000 to +8000	1250 μV	
		Current	0 to 20 mA	0 to 16000	1.25 μA
4 to 20 mA	0 to 12800		1.25 μA		
Accuracy (Accuracy in respect to full-scale digital output value)	Ambient temperature 25±5°C: within ±0.1% (±16 digits)				
	Ambient temperature 0 to 55°C: within ±0.2% (±32 digits)				
Analog output	Analog output points	2 points (2 channels)			
	Digital input	14-bit binary value			
	Analog output voltage	-10 to +10 V DC (external load resistance value 1 kΩ to 1 MΩ)			
	Analog output current	0 to 20 mA DC (external load resistance value 0 to 500 Ω)			
	Output characteristics, resolution*1	Voltage	Analog output range	Digital value	Resolution
			0 to 10 V	0 to 16000	625 μV
		0 to 5 V	0 to 16000	312.5 μV	
		1 to 5 V	0 to 16000	250 μV	
		-10 to +10 V	-8000 to +8000	1250 μV	
		Current	0 to 20 mA	0 to 16000	1.25 μA
4 to 20 mA	0 to 16000		1 μA		
Accuracy (Accuracy in respect to full-scale analog output value)	Ambient temperature 25±5°C: ±0.1 % (Voltage ±20 mV, Current ±20 μA)				
	Ambient temperature 0 to 55°C: ±0.2 % (Voltage ±40 mV, Current ±40 μA)				
Accuracy (Accuracy in respect to full-scale analog output value)	Ambient temperature -20 to 0°C: ±0.3 % (Voltage ±60 mV, Current ±60 μA)				
Absolute maximum input	Voltage: ±15 V, Current: ±30 mA				
Conversion speed	Maximum 2.0 ms (The data will be updated at every scan time of the PLC.)				
Isolation method	Between input terminal and PLC: Photocoupler Between input channels: Non-isolation				
Power supply	24 V DC +20%, -15% 100 mA (external power supply)*2 5 V DC, 10 mA (internal power supply)*2				
Compatible CPU module	FX5UJ: Ver. 1.010 or later FX5U, FX5UC: Ver. 1.240 or later				
Number of occupied input/output points	0 points (no occupied points)				
Number of connectable modules	FX5UJ, FX5U, FX5UC: Up to 2 modules to the left side of CPU module				
External dimensions W × H × D (mm)	17.6 × 106 × 89.1				
MASS (Weight): kg	Approx. 0.1				

*1: For details on the input conversion and output conversion characteristics, refer to the manual.

*2: Current consumption calculation is not required for the FX5UJ CPU module.

FX5-4AD-ADP analog input expansion adapter

◆ Features



- 1) High-precision analog input adapter with resolution of 14 bits binary.
- 2) 4-channel voltage input (-10 to +10 V DC) or current input (-20 to +20 mA DC) is allowed.
- 3) Voltage or current input can be specified for each channel.
- 4) Data can be transferred programless (no dedicated instructions).

◆ Specifications

Items	Specifications			
Analog input points	4 points (4 channels)			
Analog input voltage	-10 to +10 V DC (input resistance 1 MΩ)			
Analog input current	-20 to +20 mA DC (input resistance 250 Ω)			
Digital output value	14-bit binary value			
Input characteristics, resolution*1	Analog input range	Digital output value	Resolution	
	Voltage	0 to 10 V	0 to 16000	625 μV
		0 to 5 V	0 to 16000	312.5 μV
		1 to 5 V	0 to 12800	312.5 μV
		-10 to +10 V	-8000 to +8000	1250 μV
	Current	0 to 20 mA	0 to 16000	1.25 μA
4 to 20 mA		0 to 12800	1.25 μA	
-20 to +20 mA		-8000 to +8000	2.5 μA	
Accuracy (Accuracy in respect to full-scale digital output value)	Ambient temperature 25±5°C: within ±0.1% (±16 digits) Ambient temperature 0 to 55°C: within ±0.2% (±32 digits) Ambient temperature -20 to 0°C*2: within ±0.3% (±48 digits)			
Absolute maximum input	Voltage: ±15 V, Current: ±30 mA			
Conversion speed	Up to 450 μs (data refreshed every operation cycle)			
Isolation method	Between input terminal and PLC: Photocoupler Between input channels: Non-isolation			
Power supply	24 V DC, 20 mA (internal power supply)*3 5 V DC, 10 mA (internal power supply)*3			
Compatible CPU module	FX5UJ, FX5U, FX5UC: Compatible from initial product			
Number of occupied input/output points	0 points (no occupied points)			
Number of connectable modules	FX5UJ: Up to 2 modules to the left side of CPU module FX5U, FX5UC: Up to 4 modules to the left side of CPU module			
External dimensions W × H × D (mm)	17.6 × 106 × 89.1			
MASS (Weight): kg	Approx. 0.1			

*1: For the input conversion characteristics, refer to manuals of each product.
*2: Products manufactured earlier than June 2016 do not support this specification.
*3: Current consumption calculation is not required for the FX5UJ CPU module.

FX5-4DA-ADP analog output expansion adapter

◆ Features



- 1) High-precision analog output adapter with resolution of 14 bits binary.
- 2) 4-channel voltage output (-10 to +10 V DC) or current output (0 to 20 mA DC) is allowed.
- 3) Voltage or current output can be specified for each channel.
- 4) Data can be transferred programless (no dedicated instructions).

◆ Specifications

Items	Specifications			
Analog output points	4 points (4 channels)			
Digital input	14-bit binary value			
Analog output voltage	-10 to +10 V DC (external load resistance value 1 kΩ to 1 MΩ)			
Analog output current	0 to 20 mA DC (external load resistance value 0 to 500 Ω)			
Output characteristics, resolution*1	Analog output range	Digital value	Resolution	
	Voltage	0 to 10 V	0 to 16000	625 μV
		0 to 5 V	0 to 16000	312.5 μV
		1 to 5 V	0 to 16000	250 μV
		-10 to +10 V	-8000 to +8000	1250 μV
	Current	0 to 20 mA	0 to 16000	1.25 μA
4 to 20 mA		0 to 16000	1 μA	
Accuracy (Accuracy in respect to full-scale analog output value)	Ambient temperature 25±5°C: within ±0.1% (Voltage ±20 mV, Current ±20 μA) Ambient temperature -20 to 55°C*2: within ±0.2% (Voltage ±40 mV, Current ±40 μA)			
Conversion speed	Up to 950 μs (data refreshed every operation cycle)			
Isolation method	Between output terminal and PLC: Photocoupler Between output channels: Non-isolation			
Power supply	24 V DC +20%, -15% 160 mA (external power supply) 5 V DC, 10 mA (internal power supply)*3			
Compatible CPU module	FX5UJ, FX5U, FX5UC: Compatible from initial product			
Number of occupied input/output points	0 points (no occupied points)			
Number of connectable modules	FX5UJ: Up to 2 modules to the left side of CPU module FX5U, FX5UC: Up to 4 modules to the left side of CPU module			
External dimensions W × H × D (mm)	17.6 × 106 × 89.1			
MASS (Weight): kg	Approx. 0.1			

*1: For details on the output conversion characteristic, refer to manuals of each product.
*2: The ambient temperature specification is 0 to 55°C for products manufactured earlier than June 2016.
*3: Current consumption calculation is not required for the FX5UJ CPU module.

FX5-4AD analog input module

◆ Features



- 1) High-precision analog input module with 312.5 μV at voltage input and 625 nA at current input.
- 2) Spring clamp terminal block type with excellent vibration resistance.
- 3) Data of 10,000 points can be logged for each channel and saved in buffer memory. Leaving logs will be useful for analyzing the cause of trouble.

◆ Specifications

Items	Specifications			
Analog input points	4 points (4 channels)			
Analog input voltage	-10 to +10 V DC (Input resistance 400 k Ω or more)			
Analog input current	-20 to +20 mA DC (Input resistance 250 Ω)			
Absolute maximum input	Voltage: ± 15 V, Current: ± 30 mA			
Digital output value	16-bit signed binary (-32768 to +32767)			
Input characteristics, resolution	Analog input range	Digital output value	Resolution	
	Voltage	0 to 10 V	0 to 32000	312.5 μV
		0 to 5 V	0 to 32000	156.25 μV
		1 to 5 V	0 to 32000	125 μV
		-10 to +10 V	-32000 to +32000	312.5 μV
		User range setting	-32000 to +32000	125 μV *
	Current	0 to 20 mA	0 to 32000	625 nA
		4 to 20 mA	0 to 32000	500 nA
		-20 to +20 mA	-32000 to +32000	625 nA
User range setting		-32000 to +32000	500 nA*	
Accuracy (full scale digital output value accuracy)	Ambient temperature 25 \pm 5 $^{\circ}\text{C}$: within $\pm 0.1\%$ (± 64 digits) Ambient temperature 0 to 55 $^{\circ}\text{C}$: within $\pm 0.2\%$ (± 128 digits) Ambient temperature -20 to 0 $^{\circ}\text{C}$: within $\pm 0.3\%$ (± 192 digits)			
Conversion speed	80 $\mu\text{s}/\text{ch}$			
Isolation method	Between input terminal and PLC: Photocoupler Between input terminal channels: Non-isolation			
Power supply	5 V DC, 100 mA (internal power supply) 24 V DC, 40 mA (internal power supply)			
Compatible CPU module	FX5UJ: Compatible from initial product FX5U, FX5UC: Ver. 1.050 or later Connection with FX5UC CPU module requires connector conversion module (FX5-CNV-IFC) or extension power supply module (FX5-C1PS-5V).			
Number of occupied I/O points	8 points (Either input or output is available for counting.)			
Number of connectable modules	FX5UJ: Up to 8 modules FX5U: Up to 16 modules FX5UC: Up to 15 modules			
External dimensions W x H x D (mm)	40 x 90 x 102.2			
MASS (Weight): kg	Approx. 0.2			

*: Maximum resolution in the user range setting.

FX5-8AD multiple input module

◆ Features



- 1) High precision multi input module with 312.5 μV at voltage input and 625 nA at current input.
- 2) Spring clamp terminal block type with excellent vibration resistance.
- 3) Data of 10,000 points can be logged for each channel and saved in buffer memory. Leaving logs will be useful for analyzing the cause of trouble.

◆ Specifications

Items	Specifications			
Analog input points	8 points (8 channels)			
Analog input voltage	-10 to 10 V DC (input resistance 1 M Ω)			
Analog input current	-20 to +20 mA DC (input resistance 250 Ω)			
Absolute maximum input	Voltage: ± 15 V, Current: ± 30 mA			
Input characteristics, resolution	Analog input range	Digital output value	Resolution	
	Voltage	0 to 10 V	0 to 32000	312.5 μV
		0 to 5 V	0 to 32000	156.25 μV
		1 to 5 V	0 to 32000	125 μV
		-10 to +10 V	-32000 to +32000	312.5 μV
		User range setting	-32000 to +32000	125 μV *
	Current	0 to 20 mA	0 to 32000	625 nA
		4 to 20 mA	0 to 32000	500 nA
		-20 to +20 mA	-32000 to +32000	625 nA
Digital output value (16-bit signed binary value)	16-bit signed binary (-32000 to +32000)			
Accuracy	Ambient temperature 25 \pm 5 $^{\circ}\text{C}$: within $\pm 0.3\%$ (± 192 digits) Ambient temperature -20 to +55 $^{\circ}\text{C}$: within $\pm 0.5\%$ (± 320 digits)			
Conversion speed	1 ms/ch			
Isolation method	Between input terminal and PLC: Photocoupler Between input terminal channels: Non-isolation			
Power supply	24 V DC, 40 mA (internal power supply) 24 V DC +20%, -15% 100 mA (external power supply)			
Compatible CPU module	FX5UJ: Compatible from initial product FX5U, FX5UC: Ver. 1.050 or later Connection with FX5UC CPU module requires connector conversion module (FX5-CNV-IFC) or extension power supply module (FX5-C1PS-5V).			
Number of occupied I/O points	8 points (Either input or output is available for counting.)			
Number of connectable modules	FX5UJ: Up to 8 modules FX5U: Up to 16 modules FX5UC: Up to 15 modules			
External dimensions W x H x D (mm)	50 x 90 x 102.2			
MASS (Weight): kg	Approx. 0.3			

FX3U-4AD special function block for analog input

◆ Features



- 1) High-precision analog input module with resolution of 15 bits binary + 1-bit sign (voltage) and 14 bits binary + 1-bit sign (current).
- 2) 4-channel voltage input (-10 to +10 V DC) or current input (-20 to +20 mA DC, 4 to 20 mA DC) is allowed.
- 3) Voltage or current input can be specified for each channel.
- 4) High-speed AD conversion of 500 μ s/ch has been implemented.
- 5) Various functions such as digital filter function and peak value hold function have been provided.

◆ Specifications

Items	Input voltage	Input current
Analog input range	-10 to +10 V DC (Input resistance 200 k Ω)	-20 to +20 mA DC, 4 to 20 mA (Input resistance 250 Ω)
Effective digital output	15 bits binary + 1-bit sign	14 bits binary + 1-bit sign
Resolution	0.32 mV (20 V \times 1/64000)	1.25 μ A (40 mA \times 1/32000)
Total precision	[With ambient temperature 25°C \pm 5°C] \pm 0.3% in respect to full-scale 20 V (\pm 60 mV) [With ambient temperature 0 to 55°C] \pm 0.5% in respect to full-scale 20 V (\pm 100 mV)	[With ambient temperature 25°C \pm 5°C] With input of -20 to +20 mA \pm 0.5% (\pm 200 μ A) in respect to full-scale 40 mA Same as with input 4 to 20 mA [With ambient temperature 0 to 55°C] With input of -20 to +20 mA \pm 1% (\pm 400 μ A) in respect to full-scale 40 mA Same as with input 4 to 20 mA
Conversion speed	500 μ s \times Number of channels (5 ms \times Number of channels used when digital filter is used)	
Isolation method	Between input terminal and PLC: Photocoupler Between input terminal channels: Non-isolation	
Power supply	5 V DC, 110 mA (internal power supply) 24 V DC \pm 10% 90 mA/24 V DC (external power feed)	
Compatible CPU module	FX5U, FX5UC: Compatible from initial product Connection with FX5U/FX5UC CPU module requires bus conversion module (FX5-CNV-BUS or FX5-CNV-BUSC).	
Number of occupied input/output points	8 points (Either input or output is available for counting.)	
Communication with PLC	Carried out by FROM/TO instruction via buffer memory (buffer memory can directly be specified)	
Number of connectable modules	FX5U: Up to 8 modules when FX3U extension power supply modules are used Up to 6 modules when FX3U extension power supply modules are not used FX5UC: Up to 6 modules	
External dimensions W \times H \times D (mm)	55 \times 90 \times 87	
MASS (Weight): kg	Approx. 0.2	

FX5-4DA special function block for analog output

◆ Features

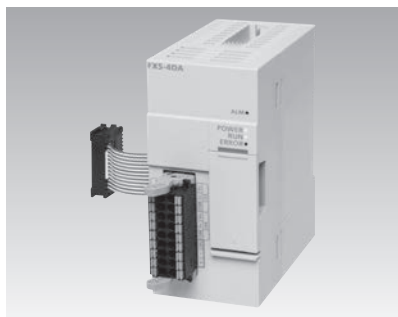

- 1) High-precision analog output module with 312.5 μ V at voltage output and 625 nA at current output.
- 2) Spring clamp terminal block type with excellent vibration resistance.
- 3) Built-in waveform output function for continuous analog output at a set conversion cycle by registering prepared waveform data (digital value) to the module extension parameter. Faster and smoother output than with programming, and program-free control for reduced overall programming work.

◆ Specifications

Items	Specifications			
Analog output points	4 points (4 channels)			
Analog output voltage	-10 to +10 V DC (external load resistance 1 k Ω to 1 M Ω)			
Analog output current	0 to 20 mA DC (external load resistance 0 to 500 Ω)			
Digital input	16-bit signed binary (-32768 to +32767)			
Output characteristics, resolution	Voltage	0 to 10 V	0 to 32000	312.5 μ V
		0 to 5 V	0 to 32000	156.3 μ V
		1 to 5 V	0 to 32000	125 μ V
		-10 to +10 V	-32000 to +32000	312.5 μ V
	Current	User range setting	-32000 to +32000	312.5 μ V*
		0 to 20 mA	0 to 32000	625 nA
		4 to 20 mA	0 to 32000	500 nA
		User range setting	-32000 to +32000	500 nA*
Accuracy (full scale analog output value accuracy)	Ambient temperature 25 \pm 5°C: within \pm 0.1% (Voltage \pm 20 mV, Current \pm 20 μ A) Ambient temperature 0 to 55°C: within \pm 0.2% (Voltage \pm 40 mV, Current \pm 40 μ A) Ambient temperature -20 to 0°C: within \pm 0.3% (Voltage \pm 60 mV, Current \pm 60 μ A)			
Conversion speed	80 μ s/ch			
Isolation method	Between output terminal and PLC: Photocoupler Between output channels: Non-isolation			
Power supply	5 V DC, 100 mA (internal power supply) 24 V DC +20%, -15% 150 mA (external power supply)			
Compatible CPU module	FX5UJ: Compatible from initial product FX5U, FX5UC: Ver. 1.050 or later Connection with FX5UC CPU module requires connector conversion module (FX5-CNV-IFC) or extension power supply module (FX5-C1PS-5V).			
Number of occupied I/O points	8 points (Either input or output is available for counting.)			
Number of connectable modules	FX5UJ: Up to 8 modules FX5U: Up to 16 modules FX5UC: Up to 15 modules			
External dimensions W \times H \times D (mm)	40 \times 90 \times 102.2			
MASS (Weight): kg	Approx. 0.2			

*: Maximum resolution in the user range setting.

FX3U-4DA special function block for analog output

◆ Features



- 1) High-precision analog output module with resolution of 15 bits binary + 1-bit sign (voltage) and 15 bits binary (current).
- 2) 4-channel voltage output (-10 to +10 V DC) or current output (0 to 20 mA DC, 4 to 20 mA DC) is allowed.
- 3) Voltage or current output can be specified for each channel.
- 4) Various functions such as table output function and upper-limit/lower-limit value function have been provided.

◆ Specifications

Items	Output voltage	Output current
Analog output range	-10 to +10 V DC (External load 1 kΩ to 1 MΩ)	0 to 20 mA DC, 4 to 20 mA DC (External load 500 Ω or less)
Effective digital input	15 bits binary + 1-bit sign	15-bit binary value
Resolution	0.32 mV (20 V × 1/64000)	0.63 μA (20 mA × 1/32000)
Total precision	Ambient temperature 25±5°C ±0.3% (±60 mV) in respect to full-scale 20 V Ambient temperature 0 to 55°C ±0.5% (±100 mV) in respect to full-scale 20 V	Ambient temperature 25±5°C ±0.3% (±60 μA) in respect to full-scale 20 mA Ambient temperature 0 to 55°C ±0.5% (±100 μA) in respect to full-scale 20 mA
Conversion speed	1 ms (unrelated to the number of channels used)	
Isolation method	Between output terminal and PLC: Photocoupler Between output terminal channels: Non-isolation	
Power supply	5 V DC, 120 mA (internal power supply) 24 V DC ±10% 160 mA/24 V DC (external power feed)	
Compatible CPU module	FX5U, FX5UC: Compatible from initial product Connection with FX5U/FX5UC CPU module requires bus conversion module (FX5-CNV-BUS or FX5-CNV-BUSC).	
Number of occupied input/output points	8 points (Either input or output is available for counting.)	
Communication with PLC	Carried out by FROM/TO instruction via buffer memory (buffer memory can directly be specified)	
Number of connectable modules	FX5U: Up to 8 modules when FX3U extension power supply modules are used Up to 6 modules when FX3U extension power supply modules are not used FX5UC: Up to 6 modules	
External dimensions W × H × D (mm)	55 × 90 × 87	
MASS (Weight): kg	Approx. 0.2	

Built-in analog input/output function of FX5U CPU module

◆ Features



- 1) FX5U CPU module has built-in analog input/output. It contains 2-channel analog input and 1-channel analog output.

◆ Specifications (built-in analog input/output only)

Items	Specifications	
A/D part	Analog input	0 to 10 V DC (Input resistance 115.7 Ω)
	Absolute maximum input	-0.5 V, +15 V
	Digital output value	0 to 4000
	Digital output	Unsigned 12-bit binary
	Maximum resolution	2.5 mV
	Precision	At ambient temperature of 25°C±5°C, within ±0.5% (±20 digit*) At ambient temperature of 0 to 55°C, within ±1.0% (±40 digit*) At ambient temperature of -20 to 0°C*2, within ±1.5% (±60 digit*)
	Conversion speed	30 μs/channels (data refreshed every operation cycle)

Items	Specifications	
D/A part	Analog output	0 to 10 V DC (External load resistance value 2 kΩ to 1 MΩ)
	Digital input value	0 to 4000
	Digital input	Unsigned 12-bit binary
	Maximum resolution	2.5 mV
	Precision	At ambient temperature of 25°C±5°C, within ±0.5% (±20 digit*) At ambient temperature of 0 to 55°C, within ±1.0% (±40 digit*) At ambient temperature of -20 to 0°C*2, within ±1.5% (±60 digit*)
	Conversion speed	30 μs (data refreshed every operation cycle)

Items	Input specifications	Output specifications	
Common part	Isolation method	Inside the PLC: Non-isolation Between input terminal channels: Non-isolation	Inside the PLC: Non-isolation
	Number of occupied input/output points	0 points (no occupied points)	
	External dimensions W × H × D (mm)	FX5U-32M□: 150 × 90 × 83 FX5U-64M□: 220 × 90 × 83 FX5U-80M□: 285 × 90 × 83	
	MASS (Weight): kg	FX5U-32M□: Approx. 0.70 FX5U-64M□: Approx. 1.00 FX5U-80M□: Approx. 1.20	

*1: Digit refers to digital values.

*2: Products manufactured earlier than June 2016 do not support this specification.





Input/Output Devices for Voltage and Current

memo

Input Device for Temperature Sensor

Platinum resistance thermometer sensor (Pt100) or thermocouple temperature sensors can be connected.
 FX5-4LC type temperature control module, which provides PID control function with auto tuning, can use a function of intelligent function module to perform temperature control.

◇ List of input devices for temperature sensor

Model (Number of channels)	Compatible sensor	Input specifications		Isolation method	Compatible CPU module			Number of channels	
		Items	Temperature input		FX5UJ	FX5U	FX5UC		
FX5-4AD-PT-ADP (4 ch) 	Resistance temperature detector Pt100, Ni100	Input range	Pt100: -200 to 850°C Ni100: -60 to 250°C	Between input terminal and PLC: Photocoupler Between input terminal channels: Non-isolation	○	○	○	4 ch	
		Resolution	0.1°C						
FX5-4AD-TC-ADP (4 ch) 	Thermocouple K, J, T, B, R, S	Input range	[Typical example] K type: -200 to 1200°C J type: -40 to 750°C	Between input terminal and PLC: Photocoupler Between input terminal channels: Non-isolation	○	○	○	4 ch	
		Resolution	0.1°C to 0.3°C (depending on the sensor used)						
FX5-8AD (8 ch) 	Resistance temperature detector Pt100, Ni100	Input range	Pt100: -200 to 850°C Ni100: -60 to 250°C	Between input terminal and PLC: Photocoupler Between input terminal channels: Non-isolation	○	○	○*	8 ch	
		Resolution	0.1°C						
	Thermocouple K, J, T, B, R, S	Input range	[Typical example] K type: -200 to 1200°C J type: -40 to 750°C						
		Resolution	0.1°C to 0.3°C (depending on the sensor used)						
FX5-4LC (4 ch) 	Resistance temperature detector 3-wire type Pt100 3-wire type JPt100 2-wire/3-wire type Pt1000	Input range	3-wire type Pt100: -200 to 600°C 3-wire type JPt100: -200 to 500°C 2-wire/3-wire type Pt1000: -200 to 650°C	Between analog input part and PLC: Photocoupler Between transistor output part and PLC: Photocoupler Between analog input part and power supply: Insulation by the DC-DC converter Between transistor output part and power supply: Insulation by the DC-DC converter Between channels: insulated	○	○	○*	4 ch	
		Resolution	0.1°C or 1°C (depends on the sensor used)						
	Thermocouple K, J, T, B, R, S, N, PLII, W5Re/W26Re, U, L	Input range	[Typical example] K type: -200.0 to 1300°C J type: -200 to 1200°C						
		Resolution	0.1°C or 1°C (depending on the sensor used)						
	Micro voltage input	Input range	0 to 10 mV DC, 0 to 100 mV DC						
		Resolution	0.5 μV, 5.0 μV						
	FX3U-4LC (4 ch) 	Resistance temperature detector 3-wire type Pt100 3-wire type JPt100 2-wire/3-wire type Pt1000	Input range	[Typical example] Pt100: -200 to 600°C Pt1000: -200.0 to 650.0°C	Between inside and channels: Photocoupler Between inside and power supply: Insulation by the DC-DC converter Between channels: insulated	×	○*2	○*2	4 ch
			Resolution	0.1°C or 1°C (depending on the sensor used)					
Thermocouple K, J, R, S, E, T, B, N, PLII, W5Re/W26Re, U, L		Input range	[Typical example] K type: -200.0 to 1300°C J type: -200.0 to 1200°C						
		Resolution	0.1°C or 1°C (depending on the sensor used)						
Micro voltage input		Input range	0 to 10 mV DC, 0 to 100 mV DC						
		Resolution	0.5 μV, 5.0 μV						

*1: Connection with FX5UC CPU module requires connector conversion module (FX5-CNV-IFO) or extension power supply module (FX5-C1PS-5V).

*2: Connection with FX5U/FX5UC CPU module requires bus conversion module (FX5-CNV-BUS or FX5-CNV-BUSC).

FX5-4AD-PT-ADP resistance temperature detector temperature sensor input expansion adapter

◆ Features

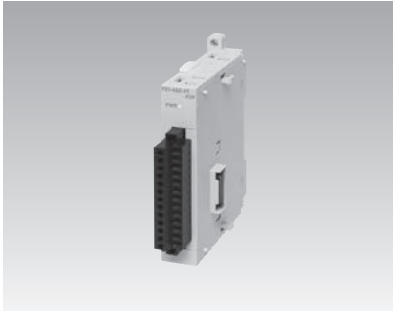

- 1) Resistance temperature detector (Pt100, Ni100) temperature sensor input expansion adapter
- 2) Four channels can be measured with high resolution of 0.1°C.
- 3) It is possible to use a combination of temperature sensors for each channel.
- 4) The measurement unit can be expressed in degrees Celsius (°C) or Fahrenheit (°F).
- 5) Data transfer is possible without programming (no dedicated instructions).

◆ Specifications

Items		Specifications	
Analog input points		4 points (4 channels)	
Usable resistance temperature detector*1		Pt100 Ni100 (DIN 43760 1987)	
Temperature measuring range	Pt100	-200 to 850°C (-328 to 1562°F)	
	Ni100	-60 to 250°C (-76 to 482°F)	
Digital output value		16-bit signed binary value	
Digital output value	Pt100	-2000 to 8500 (-3280 to 1562)	
	Ni100	-600 to 2500 (760 to 4820)	
Accuracy	Ambient temperature 25±5°C	Pt100	±0.8°C
		Ni100	±0.4°C
	Ambient temperature -20 to 55°C	Pt100	±2.4°C
		Ni100	±1.2°C
Resolution		0.1°C (0.1 to 0.2°F)	
Conversion speed*2		Approx 85 ms/channel	
Isolation method		Between input terminal and CPU module: Photocoupler Between input terminal channels: Non-isolation	
Power supply		24 V DC, 20 mA (internal power supply)*3 5 V DC, 10 mA (internal power supply)*3	
Compatible CPU module		FX5UJ: Compatible from initial product FX5U, FX5UC: Ver. 1.040 or later	
Number of occupied I/O points		0 points (no occupied points)	
Number of connectable modules		FX5UJ: Up to 2 modules to the left side of CPU module FX5U, FX5UC: Up to 4 modules to the left side of CPU module	
External dimensions W × H × D (mm)		17.8 × 106 × 89.1	
MASS (Weight): kg		Approx. 0.1	

*1: Only 3-wire type resistance temperature detectors can be used.

*2: For details of conversion speeds, refer to the manual.

*3: Current consumption calculation is not required for the FX5UJ CPU module.

FX5-4AD-TC-ADP thermocouple temperature sensor input expansion adapter

◆ Features



- 1) Thermocouple temperature sensor input expansion adapter
- 2) Four channels can be measured with high resolution of 0.1°C.
- 3) It is possible to use a combination of temperature sensors for each channel.
- 4) The measurement unit can be expressed in degrees Celsius (°C) or Fahrenheit (°F).
- 5) Data transfer is possible without programming (no dedicated instructions).

◆ Specifications

Item		Specifications		
Analog input points		4 points (4 channels)		
Applicable thermocouple*1		K, J, T, B, R, S		
Temperature measuring range	K	-200 to 1200°C (-328 to 2192°F)		
	J	-40 to 750°C (-40 to 1382°F)		
	T	-200 to 350°C (-328 to 662°F)		
	B	600 to 1700°C (1112 to 3092°F)		
	R	0 to 1600°C (32 to 2912°F)		
	S	0 to 1600°C (32 to 2912°F)		
Digital output value	16-bit signed binary value			
	K	-2000 to 12000 (-3280 to 21920)		
	J	-400 to 7500 (-400 to 13820)		
	T	-2000 to 3500 (-3280 to 6620)		
	B	6000 to 17000 (11120 to 30920)		
	R, S	0 to 16000 (320 to 29120)		
Accuracy*1	Ambient temperature 25±5°C	K	±3.7°C (-100 to 1200°C)*2	±4.9°C (-150 to -100°C)*2
		J	±2.8°C	
		T	±3.1°C (0 to 350°C)*2	±4.1°C (-100 to 0°C)*2
		B	±3.5°C	
		R	±3.7°C	
		S	±3.7°C	
	Ambient temperature -20 to 55°C	K	±6.5°C (-100 to 1200°C)*2	±7.5°C (-150 to -100°C)*2
		J	±4.5°C	
		T	±4.1°C (0 to 350°C)*2	±5.1°C (-100 to 0°C)*2
		B	±6.0°C (-150 to -100°C)*2	
		R	±6.5°C	
		S	±6.5°C	
Resolution	K, J, T	0.1°C (0.1 to 0.2°F)		
	B, R, S	0.1 to 0.3°C (0.1 to 0.6°F)		
Conversion speed*3		Approx. 85 ms/channel		
Isolation method		Between input terminal and CPU module: Photocoupler Between input terminal channels: Non-isolation		
Power supply		24 V DC, 20 mA (internal power supply)*4 5 V DC, 10 mA (internal power supply)*4		
Compatible CPU module		FX5UJ: Compatible from initial product FX5U, FX5UC: Ver. 1.040 or later		
Number of occupied I/O points		0 points (no occupied points)		
Number of connectable modules		FX5UJ: Up to 2 modules to the left side of CPU module FX5U, FX5UC: Up to 4 modules to the left side of CPU module		
External dimensions W × H × D (mm)		17.8 × 106 × 89.1		
MASS (Weight): kg		Approx. 0.1		

*1: Obtaining sufficient accuracy requires a warm-up of 45 minutes (energization).

*2: Accuracy varies depending on the measured temperature range in ().

*3: For details of conversion speeds, refer to the manual.

*4: Current consumption calculation is not required for the FX5UJ CPU module.

FX5-8AD multiple input module

◆ Features



- 1) Since a single module can handle input of voltage, current, thermocouple, and resistance temperature detector, there is no need to prepare multiple modules for different objects.
- 2) The module can easily detect a disconnection of the thermocouple or resistance temperature detector, and therefore can reduce the downtime and maintenance cost.
- 3) Data of 10000 points can be logged for each channel and saved in buffer memory. Saving logs will be useful for troubleshooting.

◆ Specifications

Item		Specifications		
Analog input points		8 points (8 channels)		
Analog input voltage		-10 to 10 V DC (input resistance 1 MΩ)		
Analog input current		-20 to +20 mA DC (input resistance 250 Ω)		
Absolute maximum input		Voltage: ±15 V, Current: ±30 mA		
Input characteristics, resolution*1	Thermocouple	K, J, T: 0.1°C (0.1 to 0.2°F) B, R, S: 0.1 to 0.3°C (0.1 to 0.6°F)		
	Resistance temperature detector	0.1°C (0.2°F)		
Digital output value (16-bit signed binary value)	Thermocouple	K: -2000 to +12000 (-3280 to +21920) J: -400 to +7500 (-400 to +13820) T: -2000 to +3500 (-3280 to +6620) B: 6000 to 17000 (11120 to 30920) R: 0 to 16000 (320 to 29120) S: 0 to 16000 (320 to 29120)		
	Resistance temperature detector	Pt100: -2000 to +8500 (-3280 to +15620) Ni100: -600 to +2500 (-760 to +4820)		
Accuracy	Thermocouple*2	Ambient temperature 25±5°C	K: ±3.5°C (-200 to -150°C) K: ±2.5°C (-150 to -100°C) K: ±1.5°C (-100 to 1200°C) J: ±1.2°C T: ±3.5°C (-200 to -150°C) T: ±2.5°C (-150 to -100°C) T: ±1.5°C (-100 to 350°C) B: ±2.3°C R: ±2.5°C S: ±2.5°C	
		Ambient temperature -20 to 55°C	K: ±8.5°C (-200 to -150°C) K: ±7.5°C (-150 to -100°C) K: ±6.5°C (-100 to 1200°C) J: ±3.5°C T: ±5.2°C (-200 to -150°C) T: ±4.2°C (-150 to -100°C) T: ±3.1°C (-100 to 350°C) B: ±6.5°C R: ±6.5°C S: ±6.5°C	
	Resistance temperature detector	Ambient temperature 25±5°C	Pt100: ±0.8°C Ni100: ±0.4°C	
		Ambient temperature -20 to 55°C	Pt100: ±2.4°C Ni100: ±1.2°C	
	Conversion speed	Thermocouple/ Resistance temperature detector	40 ms/ch	
	Isolation method	Between input terminal and PLC: Photocoupler Between input terminal channels: Non-isolation		
Power supply	24 V DC, 40 mA (internal power supply) 24 V DC +20%, -15% 100 mA (external power supply)			
Compatible CPU module	FX5UJ: Compatible from initial product FX5U, FX5UC: Ver. 1.050 or later Connection with FX5UC CPU module requires connector conversion module (FX5-CNV-IFC) or extension power supply module (FX5-C1PS-5V).			
Applicable engineering tool	FX5UJ: GX Works3 Ver. 1.060N or later FX5U, FX5UC: GX Works3 Ver. 1.025B or later			
Number of occupied I/O points	8 points (Either input or output is available for counting.)			
Number of connectable modules	FX5UJ: Up to 8 modules FX5U: Up to 16 modules FX5UC: Up to 15 modules			
External dimensions W × H × D (mm)	50 × 90 × 102.2			
MASS (Weight): kg	Approx. 0.3			

*1: For details of input characteristics, refer to the manual.

*2: To stabilize the accuracy, warm-up (supply power) the system for 30 minutes or more after power-on.

FX5-4LC temperature control module

◆ Features



- 1) Being compatible with the thermocouple, resistance temperature detector, and micro voltage input, the module can be used for a wide range of applications.
- 2) The module can suppress the overshoot in which the output value exceeds the target value or hunting phenomenon which oscillates before and after the target value.
- 3) Since the change in temperature can be checked with the waveform, parameters can be adjusted while checking the waveform displayed in real time.

◆ Specifications

Item		Specifications		
Control system		Two-position control, standard PID control, heating/cooling PID control, cascade control		
Control operation cycle		250 ms/4 ch		
Temperature measuring range		Thermocouple	K: -200 to +1300°C (-100 to +2400°F) J: -200 to +1200°C (-100 to +2100°F) T: -200 to +400°C (-300 to +700°F) S: 0 to 1700°C (0 to 3200°F) R: 0 to 1700°C (0 to 3200°F) E: -200 to +1000°C (0 to 1800°F) B: 0 to 1800°C (0 to 3000°F) N: 0 to 1300°C (0 to 2300°F) PLIL: 0 to 1200°C (0 to 2300°F) W5Re/W26Re: 0 to 2300°C (0 to 3000°F) U: -200 to +600°C (-300 to +700°F) L: 0 to 900°C (0 to 1600°F)	
		Resistance temperature detector	Pt100 (3-wire type): -200 to +600°C (-300 to +1100°F) JPt100 (3-wire type): -200 to +500°C (-300 to +900°F) Pt1000 (2-wire/3-wire type): -200.0 to +650.0°C (-328 to +1184°F)	
		Micro voltage input	0 to 10 mV DC, 0 to 100 mV DC	
		Heater disconnection detection	Alarm detection	
Input specifications	Number of input points	4 points		
	Input type (selectable for each channel)	Thermocouple	K, J, R, S, E, T, B, N, PLIL, W5Re/W26Re, U, L	
		Resistance temperature detector	3-wire type Pt100 3-wire type JPt100 2-wire/3-wire type Pt1000	
		Micro voltage input		
	Measurement accuracy*	Refer to the MELSEC iQ-F FX5 User's Manual (Temperature Control).		
	Cold junction temperature compensation error	Ambient temperature 0 to 55°C	Within ±1.0°C. When the input value is -150 to -100°C: Within ±2.0°C. When the input value is -200 to -150°C: Within ±3.0°C	
		Ambient temperature -20 to 0°C	Within ±1.8°C. When the input value is -150 to -100°C: Within ±3.6°C. When the input value is -200 to -150°C: Within ±5.4°C	
	Resolution	0.1°C (0.1°F), 1.0°C (1.0°F), 0.5 μV, or 5.0 μV (depends on the input range of the sensor used)		
	Sampling cycle	250 ms/4 ch		
	Influence of input conductor resistance (for resistance temperature detector input)	3-wire type	Approx. 0.03%/Ω for full scale, and 10 Ω or less per line	
		2-wire type	Approx. 0.04%/Ω for full scale, and 7.5 Ω or less per line	
	Influence of external resistance (for thermocouple input)	About 0.125 μV/Ω		
	Input impedance	1 MΩ or more		
Sensor current	Approx. 0.2 mA (for resistance temperature detector input)			
Operation at input disconnection/short circuit	Upscale/downscale (for resistance temperature detector input)			
Current detector (CT) input specifications	Number of input points	4 points		
	Sampling cycle	0.5 seconds		
Output specifications	Number of points: 4 Type: NPN open collector transistor output, Rated load voltage: 5 to 24 V DC Maximum load current: 100 mA, Control output cycle: 0.5 to 100.0 seconds			
Power supply	5 V DC, 140 mA (internal power supply) 24 V DC +20%, -15% 25 mA (external power supply)			
Isolation method	<ul style="list-style-type: none"> • The analog input part and between the transistor output part and PLC are insulated by the photocoupler. • The analog input part and between the transistor output part and power supply are insulated by the DC/DC converter. • Insulated between channels 			
Compatible CPU module	FX5UJ: Compatible from initial product FX5U, FX5UC: Ver. 1.050 or later Connection with FX5UC CPU module requires connector conversion module (FX5-CNV-IFC) or extension power supply module (FX5-C1PS-5V).			
Applicable engineering tool	FX5UJ: GX Works3 Ver. 1.060N or later FX5U, FX5UC: GX Works3 Ver. 1.035M or later			
Number of occupied I/O points	8 points (Either input or output is available for counting.)			
Number of connectable modules	FX5UJ: Up to 8 modules FX5U: Up to 16 modules FX5UC: Up to 15 modules			
External dimensions W × H × D (mm)	60 × 90 × 102.2			
MASS (Weight): kg	Approx. 0.3			

*: To stabilize the measurement accuracy, warm-up (supply power) the system for 30 minutes or more after power-on.

FX3U-4LC temperature control block

◆ Features



- 1) The module provides 4-ch temperature sensor input and control output through which "two-position control, standard PID control (auto-tuning possible), heating/cooling PID control, and cascade control" can be carried out. It can also be used in combination with an analog input/output module to perform PID control by voltage and current.
- 2) The module is newly equipped with cascade control. With two control loops of master and slave, the module can quickly adjust the temperature against temperature change due to disturbance or the like.
- 3) Heating/cooling PID control of up to 4 loops can be performed by output operation of 2 systems (heating output and cooling output). Temperature control can be achieved with high stability in both the heating and cooling sides.
- 4) Micro voltage signals such as "0-10 mV DC" and "0-100 mV DC" can be input. Sensors such as micro voltage output sensor can directly be connected.
- 5) The module supports a wide range of thermocouple temperature sensor and high-precision Pt1000 temperature sensor.

◆ Specifications

Items		Specifications
Control system		Two-position control, standard PID control, heating/cooling PID control, and cascade control
Control operation cycle		250 ms/4 ch
Setting temperature range*1		Thermocouple K: -200.0 to 300°C (-100 to 400°F) J: -200.0 to 200°C (-100 to 100°F)
		Resistance temperature detector Pt100 (3-wire type): -200.0 to 00.0°C (-300.0 to 100°F) Pt1000 (2-wire/3-wire type): -200.0 to 50.0°C (-328 to 184°F)
		Micro voltage input 0 to 10 mV DC, 0 to 100 mV DC
Heater disconnection detection		Detection of alarm by buffer memory (variable in the range from 0.0 to 100.0 A)
Input specifications	No. of input points	4 points
	Type of input (selectable for each channel)	[Resistance temperature detector] 3-wire type Pt100 3-wire type JPt100 2-wire/3-wire type Pt1000 [Thermocouple] K, J, R, S, E, T, B, N, PLII, W5Re/W26Re, U, L [Micro voltage input] 0 to 10 mV DC, 0 to 100 mV DC
	Example of measurement accuracy*1*2	[At ambient temperature 25°C±5°C] K type thermocouple input range is 500°C or more: Displayed value ±0.3% ±1 digit [At ambient temperature 0 to 55°C] K type thermocouple input range is 500°C or more: Displayed value ±0.7% ±1 digit
	Example of resolution*1	0.1°C (0.1°F), 1°C (1°F), 0.5 μV, or 5.0 μV
	Sampling cycle	250 ms/4 ch
	Operation at the time of input disconnection/short-circuit	Up scale/down scale (at the time of resistance thermometer sensor input)
Current detector (CT) input specification		Number of points: 4 Current detector: CTL-12-S36-8, CTL-12-S56-10, CTL-6-P-H (manufactured by U.R.D. Ltd.), sampling cycle: 0.5 sec.
Output specifications		Number of points: 4 Type: NPN open collector transistor, Rated load voltage: 5 to 24 V DC, Maximum load current: 100 mA, Control output cycle: 0.5 to 100.0 sec.
Power supply		5 V DC 160 mA (Internal power supply) 24 V DC +20% -15% 50 mA (external power feed from terminal block)
Isolation method		• The analog input part and between the transistor output part and PLC are insulated by the photocoupler. • The analog input part and between the transistor output part and power supply are insulated by the DC/DC converter. • Insulated between channels
Compatible CPU module		FX5U, FX5UC: Compatible from initial product Connection with FX5U/FX5UC CPU module requires bus conversion module (FX5-CNV-BUS or FX5-CNV-BUSC).
Number of occupied input/output points		8 points (Either input or output is available for counting.)
Communication with PLC		Carried out by FROM/TO instruction via buffer memory (buffer memory can directly be specified)
Number of connectable modules		FX5U: Up to 8 modules when FX3U extension power supply modules are used Up to 6 modules when FX3U extension power supply modules are not used FX5UC: Up to 6 modules
External dimensions W × H × D (mm)		90 × 90 × 86
MASS (Weight): kg		Approx. 0.4

*1: Differs depending on the sensor input range.

*2: To stabilize the measurement accuracy, warm-up (supply power) the system for 30 minutes or more after power-on.

High-Speed Counter

Using high-speed counters allow PLC to capture high-speed signals from encoders and sensors. Since the CPU module has built-in high performance high-speed counters, high-speed control is possible with simple programs.

List of high-speed counters

◇ Built-in high-speed counter functions of CPU module*1













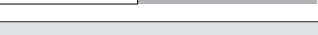

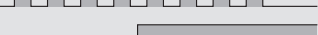
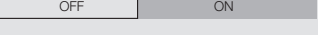















Model	Type	Maximum frequency		Operation mode	High-speed processing instruction
		FX5UJ	FX5U/FX5UC		
	1-phase, 1-input (S/W)	100 kHz*2	200 kHz	<ul style="list-style-type: none"> • Normal mode • Pulse density measurement mode • Rotation speed measurement mode 	<ul style="list-style-type: none"> • 32-bit data comparison set • 32-bit data comparison reset • 32-bit data band comparison • 16-bit data high-speed input/output function start/stop • 32-bit data high-speed input/output function start/stop
	1-phase, 1-input (H/W)	100 kHz*2	200 kHz		
	1-phase, 2-input	100 kHz	200 kHz		
	2-phase, 2-input [1 edge count]	100 kHz	200 kHz		
	2-phase, 2-input [2 edge count]	50 kHz	100 kHz		
	2-phase, 2-input [4 edge count]	25 kHz	50 kHz		
	Internal clock	1 MHz (fixed)	1 MHz (fixed)		

*1: For the details of the high-speed counter functions, refer to the manual.

*2: 1-phase, 1-input 100 kHz: 4 ch, 10 kHz: 4 ch

◇ High-speed counter of FX5UJ/FX5U/FX5UC CPU module

High-speed counters use parameters to make input allocation and function settings and use HIOEN instruction to perform operations.

Types of high-speed counters		Pulse input signal type	
1-phase, 1-input counter (S/W)		Input A phase ON  OFF 	Counting Direction Switching Bit OFF  ON 
1-phase, 1-input counter (H/W)		Input A phase ON  OFF 	Input B phase (input for switching the counting direction) OFF  ON 
1-phase, 2-input counter		Input A phase (Up-Counting Input from OFF to ON: +1) ON  OFF 	Input B phase (Down-Counting Input from OFF to ON: -1) ON  OFF 
2-phase, 2-input counter	1 edge count	At Up-Counting Input A phase  +1 Input B phase  +1	At Down-Counting Input A phase  -1 Input B phase  -1
	2 edge count	At Up-Counting Input A phase  +1 Input B phase  +1	At Down-Counting Input A phase  -1 Input B phase  -1
	4 edge count	At Up-Counting Input A phase  +1 Input B phase  +1 Input C phase  +1 Input D phase  +1	At Down-Counting Input A phase  -1 Input B phase  -1 Input C phase  -1 Input D phase  -1
Internal clock		Counting Direction Switching Bit OFF  ON 	Internal Clock (1 MHz) ON  OFF 

High-Speed Counter

◇ Built-in high-speed counter input allocation

Parameter is used to set the input device allocation of high-speed counters.

Parameter is used to set the function for each channel, and input device allocation is determined by the settings.

When internal clock is used, the allocation is the same as that of 1-phase, 1-input (S/W), without using phase A.

● FX5UJ CPU module

CH	Type of high-speed counter	X0	X1	X2	X3	X4	X5	X6	X7	X10	X11	X12	X13	X14	X15	X16	X17
CH1	1-phase, 1-input (S/W)	A	P					E									
	1-phase, 1-input (H/W)	A	B	P				E									
	1-phase, 2-input	A	B	P				E									
	2-phase, 2-input	A	B	P				E									
CH2	1-phase, 1-input (S/W)		A	P					E								
	1-phase, 1-input (H/W)		A	B	P				E								
	1-phase, 2-input		A	B	P				E								
CH3	1-phase, 1-input (S/W)			A	P					E							
	1-phase, 1-input (H/W)			A	B	P				E							
	1-phase, 2-input			A	B	P				E							
CH4	1-phase, 1-input (S/W)				A	P					E						
	1-phase, 1-input (H/W)				A	B	P				E						
	1-phase, 2-input				A	B	P				E						
	2-phase, 2-input				A	B	P				E						
CH5	1-phase, 1-input (S/W)					A	P					E					
	1-phase, 1-input (H/W)					A	B	P				E					
	1-phase, 2-input					A	B	P				E					
CH6	1-phase, 1-input (S/W)						A	P					E				
	1-phase, 1-input (H/W)						A	B	P				E				
	1-phase, 2-input						A	B	P				E				
	2-phase, 2-input						A	B	P				E				
CH7	1-phase, 1-input (S/W)							A	P					E			
	1-phase, 1-input (H/W)							A	B	P				E			
	1-phase, 2-input							A	B	P				E			
	2-phase, 2-input							A	B	P				E			
CH8	1-phase, 1-input (S/W)								A	P					E		
	1-phase, 1-input (H/W)								A	B	P				E		

A: Input A phase (In the case of 1-phase 1-input, pulse input is employed and in the case of 1-phase 2-input, pulse input of down-counting direction is employed.)

B: Input B phase (In the case of 1-phase 1-input (H/W), direction switch input is employed and in the case of 1-phase 2-input, pulse input of down-counting direction is employed.)

P: Input external preset

E: Input external enable

● FX5U/FX5UC CPU module

CH	Type of high-speed counter	X0	X1	X2	X3	X4	X5	X6	X7	X10	X11	X12	X13	X14	X15	X16	X17
CH1	1-phase, 1-input (S/W)	A								P	E						
	1-phase, 1-input (H/W)	A	B							P	E						
	1-phase, 2-input	A	B							P	E						
	2-phase, 2-input	A	B							P	E						
CH2	1-phase, 1-input (S/W)		A									P	E				
	1-phase, 1-input (H/W)			A	B							P	E				
	1-phase, 2-input			A	B							P	E				
	2-phase, 2-input			A	B							P	E				
CH3	1-phase, 1-input (S/W)			A										P	E		
	1-phase, 1-input (H/W)					A	B							P	E		
	1-phase, 2-input					A	B							P	E		
	2-phase, 2-input					A	B							P	E		
CH4	1-phase, 1-input (S/W)				A											P	E
	1-phase, 1-input (H/W)							A	B							P	E
	1-phase, 2-input							A	B							P	E
	2-phase, 2-input							A	B							P	E
CH5	1-phase, 1-input (S/W)					A				P	E						
	1-phase, 1-input (H/W)									A	B	P	E				
	1-phase, 2-input									A	B	P	E				
	2-phase, 2-input									A	B	P	E				
CH6	1-phase, 1-input (S/W)						A					P	E				
	1-phase, 1-input (H/W)											A	B	P	E		
	1-phase, 2-input											A	B	P	E		
	2-phase, 2-input											A	B	P	E		
CH7	1-phase, 1-input (S/W)							A						P	E		
	1-phase, 1-input (H/W)													A	B	P	E
	1-phase, 2-input													A	B	P	E
	2-phase, 2-input													A	B	P	E
CH8	1-phase, 1-input (S/W)								A							P	E
	1-phase, 1-input (H/W)															A	B
	1-phase, 2-input															A	B
	2-phase, 2-input															A	B
CH1 to CH8	Internal clock	Not used															

A: Input A phase
 B: Input B phase (direction switch input is however employed in the case of 1-phase 1-input [H/W])
 P: Input external preset (Use or nonuse can be selected for each channel using parameters.)
 E: Input external enable (Use or nonuse can be selected for each channel using parameters.)

High-Speed Counter

◇ High-speed pulse input/output module

Model	Type	Maximum frequency	Operation mode	High-speed processing instruction	Compatible CPU module		
					FX5UJ	FX5U	FX5UC
 FX5-16ET/ES-H FX5-16ET/ESS-H	1-phase, 1-input (S/W)	200 kHz	• Normal mode	<ul style="list-style-type: none"> • 16-bit data high-speed input/output function start/stop • 32-bit data high-speed input/output function start/stop 	×	○	○*
	1-phase, 1-input (H/W)	200 kHz					
	1-phase, 2-input	200 kHz					
	2-phase, 2-input [1 edge count]	200 kHz					
	2-phase, 2-input [2 edge count]	100 kHz					
	2-phase, 2-input [4 edge count]	50 kHz					
	Internal clock	1 MHz (fixed)					

*: Connection with FX5UC CPU module requires connector conversion module (FX5-CNV-IFC) or extension power supply module (FX5-C1PS-5V).

◇ Input assignment and the maximum frequency for each input assignment of the high-speed pulse input/output module

“□” of each input represents the prefix input number of the high-speed pulse input/output module.

“X□+6” and “X□+7” are input frequencies up to 10 kHz, regardless of maximum frequency value.

Preset input and enable input are input frequencies up to 10 kHz, regardless of maximum frequency value.

CH	High-speed counter type	X□	X□+1	X□+2	X□+3	X□+4	X□+5	X□+6	X□+7	Maximum frequency
CH9, CH11, CH13, CH15	1-phase, 1-input (S/W)	A	P					E		200 kHz
	1-phase, 1-input (H/W)	A	B	P				E		200 kHz
	1-phase, 2-input	A	B	P				E		200 kHz
	2-phase, 2-input [1 edge count]	A	B	P				E		200 kHz
	2-phase, 2-input [2 edge count]	A	B	P				E		100 kHz
	2-phase, 2-input [4 edge count]	A	B	P				E		50 kHz
CH10, CH12, CH14, CH16	1-phase, 1-input (S/W)				A	P			E	200 kHz
	1-phase, 1-input (H/W)				A	B	P		E	200 kHz
	1-phase, 2-input				A	B	P		E	200 kHz
	2-phase, 2-input [1 edge count]				A	B	P		E	200 kHz
	2-phase, 2-input [2 edge count]				A	B	P		E	100 kHz
2-phase, 2-input [4 edge count]				A	B	P		E	50 kHz	
CH9 to CH16	Internal clock	Not used								

A: Input A phase
 B: Input B phase (direction switch input is however employed in the case of 1-phase 1-input [H/W])
 P: Input external preset (Use or nonuse can be selected for each channel using parameters.)
 E: Input external enable (Use or nonuse can be selected for each channel using parameters.)

◇ High-speed counter block

Model (Number of channels)	Type	Highest response frequency	Function	Hardware comparison output function	2-phase counter edge count function	Compatible CPU module		
						FX5UJ	FX5U	FX5UC
 FX3U-2HC (2 ch)	1-phase 1-input	Max. 200 kHz	With match output (delay of up to 30 μs) function Output type: Output common to sink/source 2 points/channel	○	-	×	○* Up to 2 modules	○* Up to 2 modules
	1-phase 2-input	Max. 200 kHz						
	2-phase 2-input	1 edge count: Max. 200 kHz 2 edge count: Max. 100 kHz 4 edge count: Max. 50 kHz						

*: Connection with FX5U/FX5UC CPU module requires bus conversion module (FX5-CNV-BUS or FX5-CNV-BUSC).

FX3U-2HC high-speed counter block

◆ Features



- 1) Input of 2-ch high-speed signal can be made in a module to count a maximum of 200 kHz. Each channel is equipped with 2 high-speed output terminal points based on the setting of comparison value received from CPU module.
- 2) In 2-phase input, 1/2/4 edge count mode can be set.
- 3) Counting can be permitted/inhibited in CPU module or external input.
- 4) Connection with an encoder of line driver output type can be made.
- 5) I/O signal connection adopts a connector system and is compact.

◆ Specifications

Items	Specifications
No. of input points	2 points
Signal level	According to connection terminals, 5 V DC, 12 V DC and 24 V DC are selectable. The line driver output type is connected to the 5 V terminal.
Frequency	1-phase, 1-input: 200 kHz or less 1-phase, 2-input: 200 kHz or less 2-phase, 2-input: 200 kHz or less/1 edge count, 100 kHz or less/2 edge count, 50 kHz or less/4 edge count
Counting range	Binary signed 32 bits (-2,147,483,648 to +2,147,483,647) or binary unsigned 16 bits (0 to 65,535)
Count mode	Automatic up/down (with 1-phase 2-input or 2-phase input, or selected up/down with 1-phase 1-input)
Match output	When the current value of the counter matches a comparison set value, comparison output is set within 30 μs (ON), and cleared (OFF) within 100 μs by reset instruction.
Output type	2 points/ch, 5 to 24 V DC 0.5 A (output common to sink/source)
Additional function	Buffer memory is available to set mode and comparison data from the CPU module. Current value, comparison results, and error status can be monitored via the CPU module.
Current consumption	5 V DC 245 mA (Internal power supply)
Compatible CPU module	FX5U, FX5UC: Compatible from initial product Connection with FX5U/FX5UC CPU module requires bus conversion module (FX5-CNV-BUS or FX5-CNV-BUSC).
Number of occupied input/output points	8 points (Either input or output is available for counting.)
Communication with PLC	Carried out by FROM/TO instruction via buffer memory (buffer memory can directly be specified)
Number of connectable modules	FX5U, FX5UC: Up to 2 modules
External dimensions W × H × D (mm)	55 × 90 × 87
MASS (Weight): kg	Approx. 0.2

◆ Option

Connector for discrete wires (40-pin)

Model name	Type
FX-I/O-CON2-S	Connector for single wires AWG22 (0.3 mm ²)
FX-I/O-CON2-SA	Connector for single wires AWG20 (0.5 mm ²)

External device connection connectors and connection cables etc. are not included with the product. Please arrange them by the customer.

FX5-16ET/E□-H high-speed pulse input/output module

◆ Features

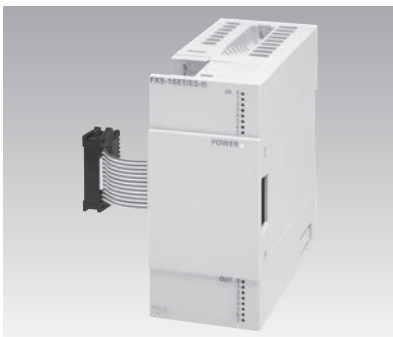

- 1) Input of high-speed pulses can be counted (2 ch, 200 kHz).
- 2) The high-speed counter function and the positioning function can be used together (2 ch + 2 axes). The terminals not assigned to high-speed input/output can be used as general-purpose inputs/outputs.

◆ Specifications

Items	Specifications
High-speed pulse input	2 ch
Input response frequency	X□ to X□+5* X□+6, X□+7*
Power supply	5 V DC, 100 mA (internal power supply) 24 V DC, 125 mA (supplied from service power supply or external power supply)
Compatible CPU module	FX5U, FX5UC from Ver. 1.030 Connection with FX5UC CPU module requires connector conversion module (FX5-CNV-IFC) or extension power supply module (FX5-C1PS-5V).
Applicable engineering tool	FX5U, FX5UC: GX Works3 Ver. 1.025B or later
Number of connectable modules	FX5U, FX5UC: Up to 4 modules
External dimensions W × H × D (mm)	40 × 90 × 83
MASS (Weight): kg	Approx. 0.25

*: "□" represents the prefix input number of each high-speed pulse input/output module.

High-Speed Counter

memo

Positioning Control

In addition to CPU module built-in positioning instructions, a pulse output module has been prepared to achieve full-scale positioning control. Furthermore, simple motion modules, which can perform complicated control as well as even multi-axis/interpolation control, are lined up to support positioning control.

List of positioning control

◇ Built-in pulse output function of CPU module

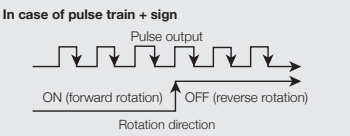
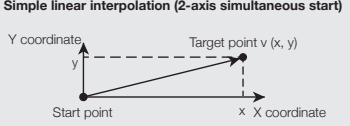
Model/feature	Items	Function
FX5UJ/FX5U/FX5UC  In case of pulse train + sign  Simple linear interpolation (2-axis simultaneous start)  The module is equipped with positioning function for 4-axis pulse output and 8-ch input.	Number of control axes	FX5UJ: 3 axes FX5U, FX5UC: 4 axes* (Simple linear interpolation by 2-axis simultaneous start)
	Maximum frequency	2147483647 (200 kpps in pulses)
	Positioning program	Sequence program, Table operation
	Compatible CPU module	Transistor output type
	Pulse output instruction	PLSY and DPLSY instructions
	Positioning instruction	DSZR, DDSZR, DVIT, DDVIT, TBL, DRVITBL, DRVMUL, DABS, PLSV, DPLSV, DRVI, DDRVI, DRVA, and DDRVA instructions



*: The number of control axes is 2 when the pulse output mode is CW/CCW mode.

◇ High-speed pulse input/output module

Model/feature	Items	Function	Compatible CPU module		
			FX5UJ	FX5U	FX5UC
FX5-16ET/ES-H FX5-16ET/ESS-H  Up to 200 kpps pulse output is possible. Because various positioning operation modes are supported, the module is suitable for 2-axis simple positioning.	Number of control axes	2 axes (Simple linear interpolation by 2-axis simultaneous start)	×	○	○*
	Maximum frequency	2147483647 (200 kpps in pulses)			
	Positioning program	Sequence program, Table operation			
	Output type	FX5-16ET/ES-H: Transistor output (Sink type) FX5-16ET/ESS-H: Transistor output (Source type)			
	Pulse output instruction	—			
	Positioning instruction	DSZR, DDSZR, DVIT, DDVIT, DRVITBL, DRVMUL, DABS, PLSV, DPLSV, DRVI, DDRVI, DRVA, and DDRVA instructions			

*: Connection with FX5UC CPU module requires connector conversion module (FX5-CNV-IFC) or extension power supply module (FX5-C1PS-5V).

◇ Pulse output module

Model/feature	Items	Function		Compatible CPU module		
		FX5-20PG-P	FX5-20PG-D	FX5UJ	FX5U	FX5UC
FX5-20PG-P FX5-20PG-D  <p>Two-axis positioning module equipped with linear interpolation and circular interpolation. By analyzing the positioning data in advance, it can start the positioning at high-speeds.</p>	Number of control axes	2 axes		○	○	○*1
	Interpolation	2-axis linear interpolation, 2-axis circular interpolation				
	Output type	Transistor	Differential driver			
	Pulse output type	PULSE/SIGN mode, CW/CCW mode Phase A/B (4 multiplication), phase A/B (1 multiplication)				
	Command speed	200 kpps	5 Mpps			
	Control system	PTP (Point To Point) control, path control (both linear and arc configurable), speed control, speed/position switching control, position/speed switching control				
	Positioning program	Sequence program				
	Positioning data	600 data/axis				
	Number of occupied I/O points	8 points (Either input or output is available for counting.)				
	FX3U-1PG  <p>Up to 200 kpps pulse output is possible. Because various positioning operation modes are supported the module is suitable for 1-axis simple positioning.</p>	Number of control axes	1 axis			
Interpolation function		—				
Command speed		200 kpps				
Output type		Transistor				
Pulse output type		Forward rotation pulse/reverse rotation pulse, or pulse train + direction				
Manual pulse generator connection		—				
Positioning program		Sequence program (FROM/TO instruction)				
ABS current value read		Allowed by a sequence program				
Number of occupied input/output points		8 points (Either input or output is available for counting.)				

*1 : Connection with FX5UC CPU module requires connector conversion module (FX5-CNV-IFC) or extension power supply module (FX5-C1PS-5V).

*2 : Connection with FX5U/FX5UC CPU module requires bus conversion module (FX5-CNV-BUS or FX5-CNV-BUSC).

◇ Simple motion module

Model/feature	Items	Function		Compatible CPU module		
		FX5-40SSC-S	FX5-80SSC-S	FX5UJ	FX5U	FX5UC
FX5-40SSC-S FX5-80SSC-S  <p>Since the module is compatible with SSCNET III/H, high-speed/high-precision positioning can be achieved in combination with MR-J4 servo motor. Parameter settings and table operation settings can easily be made with GX Works3.</p>	Number of control axes	4 axes	8 axes	○*1	○	○*2
	Interpolation function	2-axis, 3-axis, 4-axis linear interpolation 2-axis circular interpolation				
	Control system	PTP (Point To Point) control, Trajectory control (both linear and arc), Speed control, Speed-position switching control, Position-speed switching control, Speed-torque control				
	Mark detection function	Regular mode, Specified Number of Detections mode, Ring Buffer mode Mark detection signal: up to 4 points, mark detection setting: 16 settings				
	Digital oscilloscope function*3	Bit data: 16 ch, Word data: 16 ch				
	Servo amplifier connection method	SSCNET III/H				
	Manual pulse generator connection	Possible to connect 1 module				
	Positioning program	Sequence program				
	Number of occupied input/output points	8 points (Either input or output is available for counting.)				

*1: Only 1 module may be connected per system.

*2: Connection with FX5UC CPU module requires connector conversion module (FX5-CNV-IFC) or extension power supply module (FX5-C1PS-5V).

*3: 8 ch word data and 8 ch bit data can be displayed in real time.

◇ Motion module

Model/feature	Items	Function		Compatible CPU module		
		FX5-40SSC-G	FX5-80SSC-G	FX5UJ	FX5U	FX5UC
FX5-40SSC-G FX5-80SSC-G  <p>The functions of the CC-Link IE TSN-compatible MELSERVO-J5 series of high-performance servo amplifiers can be used. Also the programs of the simple motion modules can be used. Parameter settings and table operation settings can easily be made with GX Works3.</p>	Number of control axes	4 axes	8 axes			
	Interpolation function	2-axis, 3-axis, 4-axis linear interpolation 2-axis circular interpolation				
	Control system	PTP (Point To Point) control, Trajectory control (both linear and arc), Speed control, Speed-position switching control, Position-speed switching control, Speed-torque control				
	Mark detection function	Regular mode, Specified Number of Detections mode, Ring Buffer mode Mark detection signal: up to 4 points, mark detection setting: 16 settings		×	○	○*1
	Digital oscilloscope function*2	Bit data: 16 ch, Word data: 16 ch				
	Servo amplifier connection method	CC-Link IE TSN				
	Manual pulse generator connection	Possible to connect 1 module				
	Positioning program	Sequence program				
	Number of occupied input/output points	8 points (Either input or output is available for counting.)				

*1: Connection with FX5UC CPU module requires connector conversion module (FX5-CNV-IFC) or extension power supply module (FX5-C1PS-5V).

*2: 8 ch word data and 8 ch bit data can be displayed in real time.

◇ List of positioning operation modes

To confirm detailed operation of each module, refer to manuals of the product.

Positioning instruction Operation pattern	Details	FX5UJ	FX5U, FX5UC	FX5-16ET/ES-H, FX5-16ET/ESS-H	FX5-20PG-P, FX5-20PG-D	FX3U-1PG	FX5-40SSC-S, FX5-80SSC-S, FX5-40SSC-G, FX5-80SSC-G
◆ JOG operation 	While the forward rotation/reverse rotation instruction input is ON, the motor performs forward rotation/reverse rotation.	○ *1	○ *1	○ *1	○	○	○
◆ Machine home position return 	The module starts operation at a home position return speed according to the machine home position return start instruction and then outputs clear signal after the end of machine home position return.	○ *2	○ *2	○ *2	○ *2*3	○ *2*3	○ *2*4
◆ 1-speed positioning 	The module starts operation at an operation speed according to start instruction and then decelerates and stops at a target position.	○	○	○	○	○	○
◆ 2-speed operation (2-speed positioning) 	The module moves at operation speed (1) for amount of movement (1) and then moves at operation speed (2) for amount of movement (2) according to start instruction.	○ *5	○ *5	○ *5	○	○	○
◆ Multi-speed operation 	Multi-speed operation can be achieved by performing continuous trajectory control of multiple tables. The diagram at left shows continuous trajectory control of 3 tables.	○ *5	○ *5	○ *5	○	×	○
◆ Interrupt stop 	When interrupt input is ON, the module decelerates and stops.	○	○	○	×	○	×
◆ Interrupt and 1-speed positioning (interrupt and 1-speed pitch feed) 	When the interrupt input turns ON after the start of operation, the object moves the specified distance and decelerates to stop.	○	○	○	○	○	○
◆ Interrupt and 2-speed positioning (interrupt and 2-speed pitch feed) 	When the interrupt input (1) turns ON, the speed is changed to the second speed. In addition, when the interrupt input (2) turns ON, the object moves the specified distance and decelerates to stop.	○ *6	○ *6	○ *6	○ *7	○	○ *7

- *1: Can be substituted by variable speed operation instruction.
- *2: Dog search function available.
- *3: Count type, and data set type function available.
- *4: Count type, scale origin signal detection type, and data set type function available.
- *5: Can be substituted by 1-speed positioning table operation.
- *6: Can be substituted by variable speed operation or interrupt 1-speed positioning operation.
- *7: Can be substituted by speed-position switching control and speed change function.

Positioning instruction Operation pattern	Details	FX5UJ	FX5U, FX5UC	FX5-16ET/ES-H, FX5-16ET/ESS-H	FX5-20PG-P, FX5-20PG-D	FX3U-1PG	FX5-40SSC-S, FX5-80SSC-S, FX5-40SSC-G, FX5-80SSC-G																
<p>◆ Interrupt 2-speed positioning (external instruction positioning)</p>	<p>When the interrupt input turns ON, the speed is changed to the second speed. When an external instruction is turned ON, the object decelerates to stop.</p>	○ *6	○ *6	○ *6	×	○	×																
<p>◆ Variable speed operation</p>	<p>The module operates at the operation speed specified from PLC.</p>	○	○	○	○	○	○																
<p>◆ Linear interpolation</p>	<p>The module moves to the target position at the specified speed. For the speed, composite speed and reference axis speed are selectable.</p>	×	○ *8	○ *8	○	×	○																
<p>◆ Circular interpolation</p>	<p>The module moves to the target position (x, y) at the peripheral speed according to circular interpolation control. Operation can be performed according to sub point designation or center point designation.</p>	×	×	×	○	×	○																
<p>◆ Table operation</p> <table border="1"> <thead> <tr> <th>No.</th> <th>Position</th> <th>Speed</th> <th>.....</th> </tr> </thead> <tbody> <tr> <td>1</td> <td>200</td> <td>500</td> <td></td> </tr> <tr> <td>2</td> <td>500</td> <td>1000</td> <td></td> </tr> <tr> <td>3</td> <td>1000</td> <td>2000</td> <td></td> </tr> </tbody> </table>	No.	Position	Speed	1	200	500		2	500	1000		3	1000	2000		<p>A table is available to create a program for positioning control.</p>	○	○	○	○	×	○
No.	Position	Speed																				
1	200	500																					
2	500	1000																					
3	1000	2000																					
<p>◆ Pulse generator input operation</p>	<p>External pulse can be input from the manual pulse generator input terminal. Synchronous ratio operation using an encoder etc., can be performed.</p>	×	×	×	○	×	○																

*6: Can be substituted by variable speed operation or interrupt 1-speed positioning operation.
*8: Simple linear interpolation only.

Built-in positioning function of FX5UJ/FX5U/FX5UC CPU module

◆ Features



- 1) Can position up to 4 axes using transistor outputs (Y0, Y1, Y2 and Y3) of the CPU module.
- 2) Can output pulse trains of 200 kpps maximum.
- 3) Can realize a reasonable system configuration because the intelligent function module for positioning is not required.
- 4) Change of the speed and positioning address can be made during positioning operation.
- 5) Supports the simple linear interpolation operation.*2

*1: When the pulse output mode is CW/CCW, the 2 axes.
 *2: Supported only by the FX5U/FX5UC CPU module.

◆ Specifications

Items	Specifications
Number of control axes	FX5UJ: 3 axes FX5U, FX5UC: 4 axes*1 (Simple linear interpolation possible by 2-axis simultaneous start)
Maximum frequency	2147483647 (200 kpps in pulses)
Positioning program	Sequence program, Table operation
Compatible CPU module	Transistor output type
Pulse output instruction	PLSY and DPLSY instructions
Positioning instruction	DSZR, DDSZR, DVIT, DDVIT, TBL, DRVITBL, DRVMUL, DABS, PLSV, DPLSV, DRVI, DDRVI, DRVA, and DDRVA instructions

[Example of Packaging System Using built-in positioning]

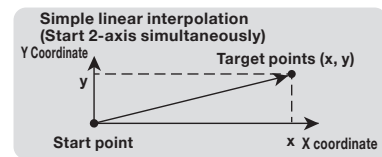
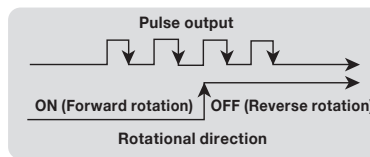
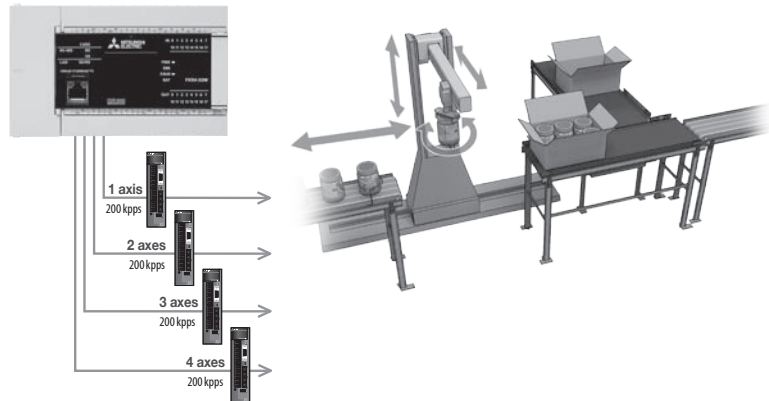

FX5-16ET/E□-H high-speed pulse input/output module

◆ Features



- 1) Can extend the high-speed counter function (2 ch) and positioning function (2 axes) at the same time, and realize a reasonable system configuration.
- 2) Offers easy extension in the same way as the positioning function built in the CPU module.
- 3) Can output pulse trains of 200 kpps maximum.
- 4) Allows terminals not using the high-speed counter function or positioning function to be used for general-purpose inputs/outputs.

◆ Specifications

Items	Specifications
Number of control axes	2 axes (Simple linear interpolation by 2-axis simultaneous start)
Maximum frequency	2147483647 (200 kpps in pulses)
Positioning program	Sequence program, Table operation
Output type	FX5-16ET/ES-H: Transistor output (Sink type) FX5-16ET/ESS-H: Transistor output (Source type)
Pulse output instruction	—
Positioning instruction	DSZR, DDSZR, DVIT, DDVIT, DRVTBL, DRVMUL, DABS, PLSV, DPLSV, DRVI, DDRVI, DRVA, and DDRVA instructions
Power supply	5 V DC, 100 mA (internal power supply) 24 V DC, 125 mA (supplied from service power supply or external power supply)
Compatible CPU module	FX5U, FX5UC from Ver. 1.030 Connection with FX5UC CPU module requires connector conversion module (FX5-CNV-IFC) or extension power supply module (FX5-C1PS-5V)..
Applicable engineering tool	FX5U, FX5UC: GX Works3 Ver. 1.025B or later
Number of connectable modules	FX5U, FX5UC: Up to 4 modules
External dimensions W × H × D (mm)	40 × 90 × 83
MASS (Weight): kg	Approx. 0.25

FX5-20PG-P 2-axis pulse train positioning module (transistor output) FX5-20PG-D 2-axis pulse train positioning module (differential line driver output)

◆ Features



- 1) By analyzing the positioning data in advance, the module can start the positioning at a higher speed than the normal positioning start.
- 2) It can easily draw the smooth path by combining linear interpolation, 2-axis circular interpolation, and continuous path control in a table-type program.
- 3) Acceleration/deceleration processing can be selected from two methods of trapezoidal and S-shaped acceleration/deceleration, and four kinds each of acceleration time and deceleration time can be set. In the case of S-shaped acceleration/deceleration, the S-character ratio can also be set.

◆ Specifications

Items	Specifications	
	FX5-20PG-P	FX5-20PG-D
Number of control axes	2 axes	
Control unit	mm, inch, degree, pulse	
Output type	Transistor	Differential line driver
Command speed	200 kpps	5 Mpps
Pulse output	Output signal: PULSE/SIGN mode, CW/CCW mode, phase A/B (4 multiplication), phase A/B (1 multiplication) Output terminal: Transistor 5 to 24 V DC 50 mA or less	Differential line driver equivalent to AM26C31
External I/O specifications	Input: READY/STOP/FLS/RLS/PG024/DOG/CHG terminals: 24 V DC 5 mA, PULSER A/PULSER B terminals: 5 V DC 14 mA Zero point signal PG05 terminal: 5 V DC 5 mA Output: CLEAR (deviation counter): 5 to 24 V DC 100 mA or less Circuit insulation: Photocoupler	
Power supply	24 V DC +20%, -15% 120 mA (external power supply)	24 V DC +20%, -15% 165 mA (external power supply)
Compatible CPU module	FX5UJ: Compatible from initial product FX5U, FX5UC: Ver. 1.050 or later Connection with FX5UC CPU module requires connector conversion module (FX5-CNV-IFC) or extension power supply module (FX5-C1PS-5V).	
Applicable engineering tool	FX5UJ: GX Works3 Ver. 1.060N or later FX5U, FX5UC: GX Works3 Ver. 1.035M or later	FX5U, FX5UC: GX Works3 Ver. 1.050C or later
Number of occupied I/O points	8 points (Either input or output is available for counting.)	
Number of connectable modules	FX5UJ: Up to 8 modules FX5U: Up to 16 modules FX5UC: Up to 15 modules	
External dimensions W x H x D (mm)	50 x 90 x 83	
MASS (Weight): kg	Approx. 0.2	

◆ Option

Connector for external devices (40-pin)

Model name	Type
A6CON1	Soldered type (straight protrusion)
A6CON2	Crimped type (straight protrusion)
A6CON4	Soldered type (both straight/inclined protrusion type)

External device connection connectors and connection cables etc. are not included with the product. Please arrange them by the customer.

FX3U-1PG pulse output block

◆ Features



- 1) The module is equipped with 7 operation modes necessary for simple positioning control.
- 2) Pulse train of up to 200 kpps can be output.
- 3) Speed and target address can be changed during positioning operation to perform operation for each process.
- 4) Approximate S-curve acceleration/deceleration is supported. Smooth high-speed operation can be performed.

◆ Specifications

Items	Specifications
Number of control axes	1 axis
Command speed	200 kpps (instruction unit can be selected from among 1 pps, cm/min, inch/min, and 10 deg/min)
Set pulse	-2,147,483,648 to 2,147,483,647 (Instruction unit can be selected from pulse, μm , mdeg, 10^{-4} inch. In addition, magnification can be set for position data.)
Pulse output	Output signal format: Forward rotation (FP)/reverse rotation (RP) pulse or pulse (PLS)/direction (DIR) can be selected. Pulse output terminal: Transistor output 5 to 24 V DC, 20 mA or less (Photocoupler, with indication of operation by LED)
External input/output specification	Input: For STOP/DOG terminal, 24 V DC, 7 mA For zero-point signal PG0 terminal, 5 to 24 V DC, 20 mA or less Output: For each of FP (forward rotation), RP (reverse rotation), and CLR (clear) terminals, 5 to 24 V DC, 20 mA or less
Driving power	For input signal: 24 V DC, 40 mA For pulse output: 5 to 24 V DC, power consumption 35 mA or less
Control power	5 V DC, 150 mA (supplied from PLC via extension cable)
Compatible CPU module	FX5U, FX5UC: Compatible from initial product Connection with FX5U/FX5UC CPU module requires bus conversion module (FX5-CNV-BUS or FX5-CNV-BUSC).
Number of occupied input/output points	8 points (Either input or output is available for counting.)
Communication with PLC	Carried out by FROM/TO instruction via buffer memory (buffer memory can directly be specified)
Number of connectable modules	FX5U : Up to 8 modules when FX3U extension power supply modules are used Up to 6 modules when FX3U extension power supply modules are not used FX5UC : Up to 6 modules
External dimensions W × H × D (mm)	43 × 90 × 87
MASS (Weight): kg	Approx. 0.2

Advanced Synchronous Control

FX5-40SSC-S and FX5-80SSC-S type simple motion modules are intelligent function modules compatible with SSCNET III/H, while the FX5-40SSC-G and FX5-80SSC-G type motion modules are compatible with CC-Link IE TSN.

They can be used for positioning control by servo motor via SSCNET III/H or CC-Link IE TSN-compatible servo amplifiers. For positioning control, refer to the relevant manual.

FX5-40SSC-S type simple motion module FX5-80SSC-S type simple motion module

◆ Features



FX5-40SSC-S and FX5-80SSC-S are equipped with the 4/8-axis positioning functions compatible with SSCNET III/H. By combining linear interpolation, 2-axis circular interpolation and continuous trajectory control in the program set with a table, a smooth trajectory can be easily drawn. In "synchronous control", "parameter for synchronous control" is set and synchronous control is started for each output axis to perform control in synchronization with the input axes (servo input axis, instruction generation axis*1, and synchronous encoder axis).

*1: The instruction generation axis is used only for instruction generation. It can be controlled independently as an axis connected to a servo amplifier. (It is not counted as a control axis.)

◆ Specifications

Items		Specifications	
		FX5-40SSC-S	FX5-80SSC-S
Number of control axes		4 axes	8 axes
Operation cycle [ms]		0.888/1.777	
Interpolation function		Linear interpolation (maximum 4 axes), two-axis circular interpolation	
Control system		PTP (Point To Point) control, Trajectory control (both linear and arc), Speed control, Speed-position switching control, Position-speed switching control, Speed-torque control	
Acceleration/deceleration process		Trapezoidal acceleration/deceleration, S-curve acceleration/deceleration	
Synchronous control	Input axis	Servo input axis, synchronous encoder axis, command generation axis	
	Output axis	Cam shaft	
Cam control	Number of registration*2	Up to 64 cams	Up to 128 cams
	Cam data type	Stroke ratio data type, Coordinate data type	
	Cam auto-generation	Cam auto-generation for rotary cutter	
Control unit		mm, inch, degree, pulse	
Number of positioning data		600 data (positioning data No. 1 to 600)/axis (Can be set with MELSOFT GX Works3 or a sequence program.)	
Backup		Parameters, positioning data, and block start data can be saved on flash ROM (battery-less backup)	
Positioning control	Linear control	1-axis linear control, 2-axis linear interpolation control, 3-axis linear interpolation control, 4-axis linear interpolation control*3 (Composite speed, Reference axis speed)	
	Fixed-pitch feed control	1-axis fixed-pitch feed, 2-axis fixed-pitch feed, 3-axis fixed-pitch feed, 4-axis fixed-pitch feed*3	
	2-axis circular interpolation	Sub point designation, center point designation	
	Speed control	1-axis speed control, 2-axis speed control*3, 3-axis speed control*3, 4-axis speed control*3	
	Speed-position switching control	INC mode, ABS mode	
	Position-speed switching control	INC mode	
	Current value change	Positioning data, Start No. for a current value changing	
	NOP instruction	Provided	
	JUMP instruction	Unconditional JUMP, Conditional JUMP	
	LOOP, LEND	Provided	
High-level positioning control	Block start, Condition start, Wait start, Simultaneous start, Repeated start		
Servo amplifier connection method		SSCNET III/H	
Maximum overall cable distance [m]		400	
Maximum distance between stations [m]		100	
24 V DC external current consumption		250 mA	
Compatible CPU module		FX5UJ, FX5U, FX5UC: Compatible from initial product	
Applicable engineering tool		FX5UJ: GX Works3 Ver. 1.060N or later FX5U, FX5UC: GX Works3 Ver. 1.030G or later	
Number of occupied input/output points		8 points (Either input or output is available for counting.)	
Number of connectable modules		FX5UJ: Up to 1 module (FX5-40SSC-S and FX5-80SSC-S cannot be used simultaneously.) FX5U: Up to 16 modules FX5UC: Up to 15 modules	
External dimensions W × H × D (mm)		50 × 90 × 83	
MASS (Weight): kg		Approx. 0.3	

*2: The number of registered cams varies depending on the memory capacity, cam resolution, and the number of coordinates.
*3: Only the reference axis speed is effective for the interpolation speed specification method.

FX5-40SSC-G type motion module
FX5-80SSC-G type motion module

◆ Features



FX5-40SSC-G and FX5-80SSC-G are CC-Link IE TSN compatible modules provided with 4-/8-axis positioning function.

The functions of the CC-Link IE TSN compatible MELSERVO-J5 series of high-performance servo amplifiers can be used. Also the programs of the simple motion modules can be used.

◆ Specifications

Items	Specifications		
	FX5-40SSC-G	FX5-80SSC-G	
Number of control axes	4 axes	8 axes	
Operation cycle [ms]	0.500/1.000/2.000/4.000		
Interpolation function	Linear interpolation (maximum 4 axes), two-axis circular interpolation		
Control system	PTP (Point To Point) control, Trajectory control (both linear and arc), Speed control, Speed-position switching control, Position-speed switching control, Speed-torque control		
Acceleration/deceleration process	Trapezoidal acceleration/deceleration, S-curve acceleration/deceleration		
Synchronous control	Synchronous encoder input, command generation axis, cam, phase compensation, cam auto-generation		
Cam control	Number of registration*1	Up to 128 cams	
	Cam data type	Stroke ratio data type, Coordinate data type	
	Cam auto-generation	Cam auto-generation for rotary cutter	
Control unit	mm, inch, degree, pulse		
Number of positioning data	600 data (positioning data No. 1 to 600)/axis (Can be set with MELSOFT GX Works3 or a sequence program.)		
Backup	Parameters, positioning data, and block start data can be saved on flash ROM (battery-less backup)		
Positioning control	Linear control	1-axis linear control, 2-axis linear interpolation control, 3-axis linear interpolation control, 4-axis linear interpolation control*2 (Composite speed, Reference axis speed)	
	Fixed-pitch feed control	1-axis fixed-pitch feed, 2-axis fixed-pitch feed, 3-axis fixed-pitch feed, 4-axis fixed-pitch feed*2	
	2-axis circular interpolation	Sub point designation, center point designation	
	Speed control	1-axis speed control, 2-axis speed control*2, 3-axis speed control*2, 4-axis speed control*2	
	Speed-position switching control	INC mode, ABS mode	
	Position-speed switching control	INC mode	
	Current value change	Positioning data, Start No. for a current value changing	
	NOP instruction	Provided	
	JUMP instruction	Unconditional JUMP, Conditional JUMP	
	LOOP, LEND	Provided	
High-level positioning control	Block start, Condition start, Wait start, Simultaneous start, Repeated start		
Servo amplifier connection method	CC-Link IE TSN		
Maximum overall cable distance [m]	Line topology	1900 (when 20 modules are connected)	2300 (when 24 modules are connected)
	Others	Depends on the system configuration.	
Maximum distance between stations [m]	100		
24 V DC external current consumption	240 mA		
Compatible CPU module	FX5U, FX5UC: Ver. 1.230 or later		
Applicable engineering tool	FX5U, FX5UC: GX Works3 Ver. 1.072A or later		
Number of occupied input/output points	8 points (Either input or output is available for counting.)		
Number of connectable modules	FX5U, FX5UC: Up to 4 module		
External dimensions W x H x D (mm)	50 x 90 x 83		
MASS (Weight): kg	Approx. 0.3		

*1: The number of registered cams varies depending on the memory capacity, cam resolution, and the number of coordinates.
 *2: Only the reference axis speed is effective for the interpolation speed specification method.

memo

Network/Communication/Information-sharing

MELSEC iQ-F Series can support not only high-speed networks like CC-Link but also other networks corresponding to control contents such as Ethernet, MODBUS, Sensor Solution, and PROFIBUS-DP. In addition, communication function to easily establish simple data link between MELSEC iQ-F Series and to RS-232C and RS-485 devices is also supported.

◇ CC-Link

Examples of connection are shown.

Types	Contents	Total extension length or transmission distance	Station types	Compatible CPU module		
				FX5UJ	FX5U	FX5UC
<p>CC-Link IE TSN (CC-Link IE TSN system by the MELSEC iQ-F series master)</p> <p>For star connections</p>	<ul style="list-style-type: none"> ● Outline MELSEC iQ-F series can be connected as a local station to the CC-Link IE TSN system in which the MELSEC iQ-F series is the master station. ● Scale Max. 61 modules*1 (1 master station, 60 slave stations) ● Scope Distributed control and central management of lines, information transfer from the host network, etc. 	<p>Line topology: 6000 m (With 61 modules connected)</p> <p>Star topology: Depending on the system configuration</p>	<p>Master station or local station (FX5-CCLGN-MS)</p>	×	○	○*2
<p>CC-Link IE TSN (CC-Link IE TSN system by the MELSEC iQ-R series master)</p> <p>For star connections</p>	<ul style="list-style-type: none"> ● Outline MELSEC iQ-R series can be connected as a local station to the CC-Link IE TSN system in which the MELSEC iQ-F series is the master station. ● Scale Max. 121 modules*1 (1 master station, 120 slave stations) ● Scope Distributed control and central management of lines, information transfer from the host network, etc. 	<p>Line topology: 12000 m (With 121 modules connected)</p> <p>Star topology: Depending on the system configuration</p> <p>Ring topology: The FX5-CCLGN-MS is not compatible.</p>	<p>Local station (FX5-CCLGN-MS)</p>	×	○	○*2
<p>CC-Link IE Field Network</p> <p>For star connections</p>	<ul style="list-style-type: none"> ● Outline MELSEC iQ-F Series can be connected as intelligent device stations for the CC-Link IE Field Network system using MELSEC iQ-R series as master station. ● Scale Max. 121 modules (1 master station, 120 slave stations) ● Scope Distributed control and central management of lines, information transfer from the host network, etc. 	<p>Line topology: 12000 m (With 121 modules connected)</p> <p>Star topology: Depending on the system configuration</p> <p>Ring topology: 12100 m (With 121 modules connected)</p>	<p>Intelligent device station (FX5-CCLIEF)</p>	○	○	○*2
<p>CC-Link IE Field Network Basic</p>	<ul style="list-style-type: none"> ● Outline CC-Link IE Field Network Basic is an FA network utilizing general-purpose Ethernet. Data communication is performed periodically (cyclic transmission) using a link between the master station and slave station. ● Scale FX5UJ: Up to 8 modules FX5U/FX5UC: Up to 16 modules FX5-ENET: Up to 32 modules ● Scope Distributed control and centralized management of lines, and exchange of information with upper network 	<p>Depending on the system configuration</p>	<p>Master station (FX5UJ/FX5U/FX5UC)</p> <p>Master station (FX5-ENET)</p>	○	○	○

*1: The numbers of stations shown above include the master station. When more than 1 master station (FX5-CCLGN-MS, FX5-40/80SSC-G, etc.) using the slave station parameters is connected to the CPU module, the total number of the slave stations must be less than the number of the slave station parameter files that can be saved in the CPU module. For details about the number of slave station parameter files that can be saved in the CPU module, refer to the manual.
*2: Connection with FX5UC CPU module requires connector conversion module (FX5-CNV-IFC) or extension power supply module (FX5-C1PS-5V).

Network/Communication/Information-sharing

Types	Contents	Total extension length or transmission distance	Station types	Compatible CPU module		
				FX5UJ	FX5U	FX5UC
<p>CC-Link V2 (CC-Link V2 system with MELSEC iQ-F Series master)</p>	<ul style="list-style-type: none"> ● Outline This is a CC-Link V2 system where MELSEC iQ-F Series is used as master station. CC-Link V2 system can be established using just MELSEC iQ-F Series. Ver. 1.10 is also supported. ● Scale Remote I/O station: max. 14*1*2 modules Intelligent device station or remote device station: max. 14*1*3 modules ● Scope Distributed control and central management of lines, configuration of small-scale and high-speed network, etc. 	Max.1200 m	Master station (FX5-CCL-MS)	○	○	○*4
			Master station (FX3U-16CCL-M)	×	○*5	○*5
			Intelligent device station (FX3U-64CCL)	×	○*5	○*5
<p>CC-Link V2 (CC-Link V2 system with MELSEC iQ-R Series master)</p>	<ul style="list-style-type: none"> ● Outline MELSEC iQ-F series can be connected as an intelligent device station to the CC-Link V2 system in which the MELSEC iQ-R series etc. is the master station. ● Scale Max. 64 modules ● Scope Distributed control and central management of lines, information transfer from the host network, etc. 	Max.1200 m	Intelligent device station (FX5-CCL-MS)	○	○	○*4
			Intelligent device station (FX3U-64CCL)	×	○*5	○*5

*1: This number is applicable when FX5-CCL-MS is used as the master station. The maximum number is 8 when FX3U-16CCL-M is used as the master station.

*2: Up to 6 stations when connected with the FX5UJ.

*3: Up to 8 stations when connected with the FX5UJ.

*4: Connection with FX5UC CPU module requires connector conversion module (FX5-CNV-IFC) or extension power supply module (FX5-C1PS-5V).

*5: Connection with FX5U/FX5UC CPU module requires bus conversion module (FX5-CNV-BUS or FX5-CNV-BUSC).

◆ Ethernet

Examples of connection are shown.

Types	Contents	Total extension length or transmission distance	Compatible CPU module		
			FX5UJ	FX5U	FX5UC
<p>FX5UJ/FX5U/FX5UC CPU Module</p>	<ul style="list-style-type: none"> ● Outline The general-purpose Ethernet communication using the built-in Ethernet port enables the simultaneous use of some protocols. ● Protocol type Compatible with CC-Link IE Field Network Basic, MELSOFT connection, SLMP server (3E/1E*1 frame), socket communications, communication protocol support, FTP server, FTP client*1, MODBUS/TCP communication, SNTIP client, Web server (HTTP), simple CPU communication function ● Scale 1:n ● Scope Distributed control of lines, central management, data collection, program maintenance, etc. 	—	○	○	○
<p>FX5-ENET</p>	<ul style="list-style-type: none"> ● Outline The general-purpose Ethernet communication in the Ethernet module using the built-in Ethernet port enables the simultaneous use of some protocols. ● Protocol type CC-Link IE Field Network Basic, MELSOFT connection, SLMP server (3E/1E frame), Socket communication, simple CPU communication, BACnet/IP ● Scale 1:n ● Scope Distributed control of lines, central management, data collection, etc. 	—	○	○	○*2
<p>FX5-ENET/IP</p>	<ul style="list-style-type: none"> ● Outline The general-purpose Ethernet communication in the Ethernet module using the built-in Ethernet port enables the simultaneous use of some protocols. ● Protocol type EtherNet/IP communication, MELSOFT connection, SLMP server (3E/1E frame), Socket communication, simple CPU communication, BACnet/IP ● Scale 1:n ● Scope Distributed control of lines, central management, data collection, etc. 	—	○	○	○*2

*1: Supported only by the FX5U/FX5UC CPU module.

*2: Connection with FX5UC CPU module requires connector conversion module (FX5-CNV-IFC) or extension power supply module (FX5-C1PS-5V).

◇ EtherNet/IP

Examples of connection are shown.

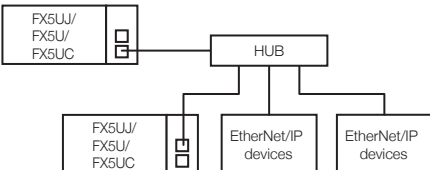
Types	Contents	Total extension length or transmission distance	Compatible CPU module		
			FX5UJ	FX5U	FX5UC
<p>FX5-ENET/IP</p> 	<ul style="list-style-type: none"> ● Outline Seamless communication with the EtherNet/IP network can be realized by using the CiP communication protocol. ● Scale 1:n ● Scope Distributed control of lines, central management, data collection, etc. 	—	○	○	○*

*: Connection with FX5UC CPU module requires connector conversion module (FX5-CNV-IFC) or extension power supply module (FX5-C1PS-5V).

◇ BACnet

Examples of connection are shown.

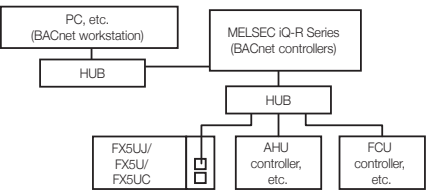
Types	Contents	Total extension length or transmission distance	Compatible CPU module		
			FX5UJ	FX5U	FX5UC
<p>FX5-ENET, FX5-ENET/IP</p> 	<ul style="list-style-type: none"> ● Outline FX5-ENET(IP) can be used as a BACnet device. Analog values and digital values are provided as inputs/outputs to the workstation and controller. ● Scale Number of registrable input/output objects: 92 instances ● Scope Control of air conditioning and lighting inside buildings 	—	○	○	○*

*: Connection with FX5UC CPU module requires connector conversion module (FX5-CNV-IFC) or extension power supply module (FX5-C1PS-5V).

◇ Simple CPU communication

Examples of connection are shown.

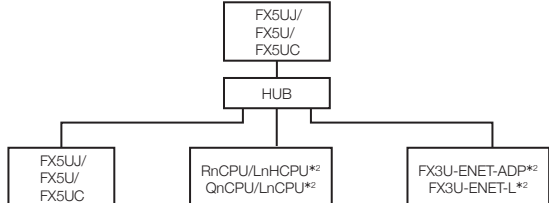
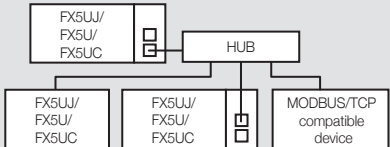
Types	Contents	Total extension length or transmission distance	Compatible CPU module		
			FX5UJ	FX5U	FX5UC
<p>Simple CPU communication (with built-in Ethernet port)</p> 	<ul style="list-style-type: none"> ● Outline Transmit and receive data from a specified device at a specified timing using the built-in Ethernet function. ● Scale Max. 16 modules*1 ● Scope Distributed control of lines, central management, data collection, etc. 	—	○	○	○
<p>FX5-ENET, FX5-ENET/IP</p> 	<ul style="list-style-type: none"> ● Outline This function uses the built-in Ethernet port in the Ethernet module to send/receive the specified device data at the specified timing. ● Scale Maximum number of connected: 32 modules ● Scope Distributed control of lines, central management, data collection, etc. 	—	○	○	○*3

*1: When the simple CPU communication function is set on the FX5UJ CPU module, the module can communicate with up to 8 modules.

*2: Supported only by the FX5U/FX5UC CPU module.

*3: Connection with FX5UC CPU module requires connector conversion module (FX5-CNV-IFC) or extension power supply module (FX5-C1PS-5V).

◇ MODBUS

Examples of connection are shown.

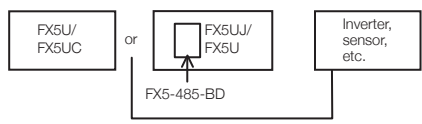
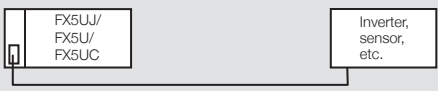
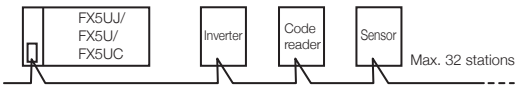
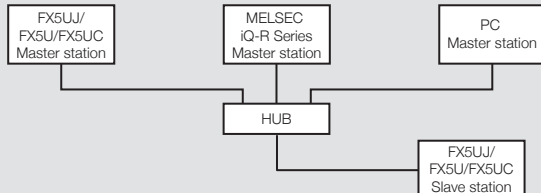
Types	Contents	Total extension length or transmission distance	Compatible CPU module		
			FX5UJ	FX5U	FX5UC
<p>FX5U/FX5UC CPU Module (built-in RS-485 port), FX5-485-BD</p> 	<ul style="list-style-type: none"> ● Outline The FX5 can be connected as a master or a slave to the MODBUS/RTU device via the RS-485. ● Scale Max. 32 stations ● Scope Configuration of small-size and high-speed network, etc. 	Max. 50 m	○*2	○	○*1
<p>FX5-232ADP, FX5-232-BD</p> 	<ul style="list-style-type: none"> ● Outline The FX5 can be connected as a master or a slave to the MODBUS/RTU device via the RS-232C. ● Scale 1:1 ● Scope Data transfer from PCs, code readers, printers, various measurement devices, etc. 	Max. 15 m	○	○	○*1
<p>FX5-485ADP</p> 	<ul style="list-style-type: none"> ● Outline The FX5 can be connected as a master or a slave to the MODBUS/RTU device via the RS-485. ● Scale Max. 32 stations ● Scope Distributed control of lines, central management, etc. 	Max. 1200 m	○	○	○
<p>FX5UJ/FX5U/FX5UC CPU module (with built-in Ethernet port)</p> 	<ul style="list-style-type: none"> ● Outline Connections with the FX5 set as the master*3 or slave station are possible via Ethernet connection to various MODBUS/TCP devices. ● Scale Up to 8 connections ● Scope Distributed control of lines, central management, data collection, program maintenance, etc. 	—	○	○	○

*1: No expansion board can be used in FX5UC.
 *2: FX5UJ does not have a built-in RS-485 port.
 *3: The communication protocol support function is used.

◇ Sensor Solution

Examples of connection are shown.

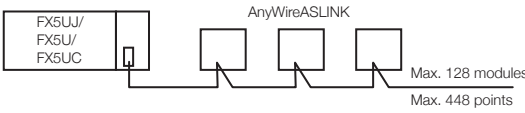
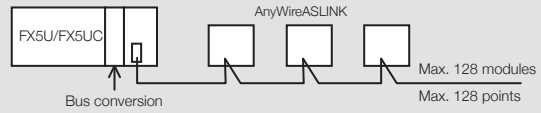
Types	Contents	Total extension length or transmission distance	Compatible CPU module		
			FX5UJ	FX5U	FX5UC
<p>FX5-ASL-M</p> 	<ul style="list-style-type: none"> ● Outline This is the master module of the AnyWireASLINK system. A sensor saving wiring system of AnyWireASLINK system can be constructed. ● Scale Max. 128 modules ● Scope Distributed control of lines, central management of sensors, etc. 	Max. 200 m	○	○	○*1
<p>FX3U-128ASL-M</p> 	<ul style="list-style-type: none"> ● Outline This is the master module of the AnyWireASLINK system. A sensor saving wiring system of AnyWireASLINK system can be constructed. ● Scale Max. 128 modules ● Scope Distributed control of lines, central management of sensors, etc. 	Max. 200 m	×	○*2	○*2

*1: Connection with FX5UC CPU module requires connector conversion module (FX5-CNV-IFC) or extension power supply module (FX5-C1PS-5V).
 *2: Connection with FX5U/FX5UC CPU module requires bus conversion module (FX5-CNV-BUS or FX5-CNV-BUSC).

◇ PROFIBUS-DP

Examples of connection are shown.



Types	Contents	Total extension length or transmission distance	Station type	Compatible CPU module		
				FX5UJ	FX5U	FX5UC
<p>FX5-DP-M</p>	<ul style="list-style-type: none"> ● Outline This PROFIBUS-DP system uses the MELSEC iQ-F Series as the master station. Using this product makes it possible to incorporate PROFIBUS-compatible slave devices used throughout Europe into the system. ● Scale Up to 64 modules ● Scope Distributed control and centralized management of lines, exchange of information with upper network, etc. 	Up to 4800 m when repeaters are used	Master station	○	○	○*2
<p>FX3U-32DP</p>	<ul style="list-style-type: none"> ● Outline Connectable as a slave station to PROFIBUS-DP systems using the MELSEC iQ-F Series as the master station. ● Scale Up to 64 modules ● Scope Distributed control and centralized management of lines, exchange of information with upper network, etc. 	Up to 4800 m when repeaters are used	Slave stations	×	○*3	○*3

*1: Any station number can be set for the master station.

*2: Connection with FX5UC CPU module requires connector conversion module (FX5-CNV-IFC) or extension power supply module (FX5-C1PS-5V).

*3: Connection with FX5U/FX5UC CPU module requires bus conversion module (FX5-CNV-BUS or FX5-CNV-BUSC).

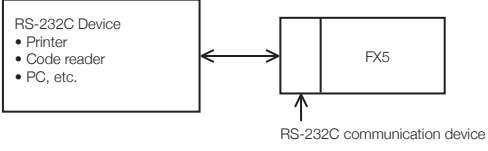
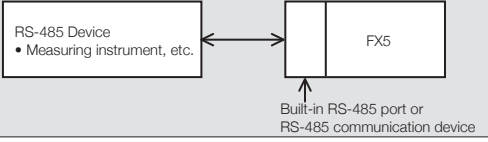
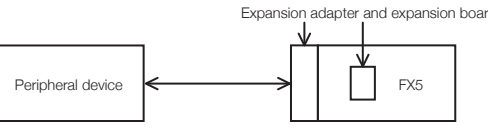
◇ **General-purpose communication/peripheral device communication** Examples of connection are shown.

Types	Contents	Distance	Compatible CPU module		
			FX5UJ	FX5U	FX5UC
RS-232C Communication (Communication between FX5 and RS-232C device) 	<ul style="list-style-type: none"> ● Outline Data can be transferred from various devices with built-in RS-232C interface by non-protocol communication. ● Scale 1:1 ● Scope Data transfer from PCs, code readers, printers, various measurement devices, etc. 	Max. 15 m	○	○	○*2
RS-485 Communication (Communication between FX5 and RS-485 device) 	<ul style="list-style-type: none"> ● Outline Data can be transferred from various devices with built-in RS-485 interface by non-communication protocol. ● Scale 1:1 (1:n) ● Scope Data transfer from PCs, code readers, printers, various measuring instrument, etc. 	Max. 50 m or 1200 m	○*1	○	○*2
Addition of peripheral device connection port (Connection between FX5 and peripheral device) 	<ul style="list-style-type: none"> ● Outline RS-232C or RS-422 port (GOT port) can be added. ● Scale 1:1 ● Scope Simultaneous connection of two HMI, etc. 	[RS-422] Depends on peripheral devices to be connected. [RS-232C] Max.15 m	○	○	○*2
USB communication 	<ul style="list-style-type: none"> ● Outline It can be connected with an engineering tool (GX Works3, etc.) by connecting the built-in USB port in the FX5UJ CPU module directly with a PC. ● Scale Maximum number of connected: 1 module ● Scope Programming communication using engineering tools 	—	○	×	×

*1: FX5UJ does not have a built-in RS-485 port.
 *2: No expansion board can be used in FX5UC.

◇ Data link

Examples of connection are shown.

Types	Contents	Total extension length or transmission distance	Compatible CPU module		
			FX5UJ	FX5U	FX5UC
<p>N:N network (n:n connection)</p>	<ul style="list-style-type: none"> ● Outline: Enabling a simple data link between FX5 and FX3. ● Scale: Max. 8 modules ● Scope: Distributed control and central management of lines, etc. 	Max. 50 m or 1200 m	○*1	○	○*2
<p>Parallel link</p> <p>Built-in RS-485 port or RS-485 communication device</p>	<ul style="list-style-type: none"> ● Outline: With two FX5 PLCs connected, devices can be linked to each other. The data link is automatically updated between the two FX5 PLCs. ● Scale: 1:1 ● Scope: Distributed control and centralized control of small-scale lines 	Max. 50 m or 1200 m	○*1	○	○*2
<p>MC protocol (1: n connection to external device)</p>	<ul style="list-style-type: none"> ● Outline: FX5 can be connected as a slave station by setting an external device (PC, etc.) as a master station. Frame 1C: Compatible to Type 1/Type 4 Frame 3C: Compatible to Type 1/Type 4 Frame 4C: Compatible to Type 1/Type 4/Type 5 ● Scale: 1:n (n = max. 16 modules) ● Scope: Distributed control and central management of lines, etc. 	Max. 50 m or 1200 m	○*1	○	○*2
<p>MC protocol (1:1 connection to external device)</p>	<ul style="list-style-type: none"> ● Outline: FX5 can be connected as a slave station by setting an external device (PC, etc.) as a master station. Frame 1C: Compatible to Type 1/Type 4 Frame 3C: Compatible to Type 1/Type 4 Frame 4C: Compatible to Type 1/Type 4/Type 5 ● Scale: 1:1 ● Scope: Data collection, central management, etc. 	Max. 15 m	○	○	○*2

*1: FX5UJ does not have a built-in RS-485 port.
 *2: No expansion board can be used in FX5UC.

◇ OPC UA communication

Examples of connection are shown.

Types	Contents	Total extension length or transmission distance	Compatible CPU module		
			FX5UJ	FX5U	FX5UC
<p>FX5-OPC</p>	<ul style="list-style-type: none"> ● Outline: Information on PLC input/output and internal registers is exchanged between the OPC UA server (FX5-OPC) and the OPC UA client (external application or device). ● Scale: Maximum number of parallel sessions : 4 ● Scope: Data collection 	—	×	○	○*

*: Connection with FX5UC CPU module requires connector conversion module (FX5-CNV-IFC) or extension power supply module (FX5-C1PS-5V).

CC-Link IE TSN

CC-Link IE TSN

CC-Link IE TSN supports TCP/IP communications and applies it to industrial architectures through its support of TSN enabling real-time communications. FX5-CCLGN-MS is an intelligent function module intended for connecting the FX5U/FX5UC CPU module as a master or local station of the CC-Link IE TSN.

FX5-CCLGN-MS master/local module for CC-Link IE TSN

◆ Features



- 1) The FX5U/FX5UC CPU module can be connected as a master or local station of the CC-Link IE TSN.
- 2) Data can be transferred between the FX5U/FX5UC CPU module and the FX5-CCLGN-MS via buffer memory by using the FROM/TO instruction. Data can be used in programs through replacement with internal devices (X, Y, B, W, SB, SW, etc.) via the automatic refresh function.

- *1: The maximum number of points for all link devices may not be used simultaneously depending on the number of slave stations, or the number of points and assignments of the link devices that are set in the "Network Configuration Settings" of the "Basic Settings".
- *2: The maximum number of connectable stations (61) includes the master station. When connecting multiple master stations, such as the FX5-CCLGN-M and the FX5-40/80SSC-G, which use slave station parameters for the CPU module, the total number of slave stations must be less than or equal to the number of slave station parameter files that can be saved in the CPU module. For details about the number of slave station parameter files that can be saved in the CPU module, refer to the following manual.
→ MELSEC iQ-F FX5 User's Manual (Application)

◆ Specifications

Items		Specifications	
Station type		Master or local station	
Station number		<ul style="list-style-type: none"> • Master station: 0 • Local station: 1 to 120 	
Maximum number of link points per network	RX	16 K points (16384 points, 2 K bytes)	
	RY	16 K points (16384 points, 2 K bytes)	
	RWr	8 K points (8192 points, 16 K bytes)	
	RWw	8 K points (8192 points, 16 K bytes)	
Maximum number of link points per station*1	Master station	RX	8 K points (8192 points, 1 K bytes)
		RY	8 K points (8192 points, 1 K bytes)
		RWr	4 K points (4096 points, 8 K bytes)
		RWw	4 K points (4096 points, 8 K bytes)
	Local station	RX	16 K points (16384 points, 2 K bytes)
		RY	16 K points (16384 points, 2 K bytes)
		RWr	8 K points (8192 points, 16 K bytes)
		RWw	8 K points (8192 points, 16 K bytes)
Communication speed		1 Gbps	
Minimum synchronization cycle		250.00 μs	
Authentication Class		Authentication Class B device	
Maximum number of connectable stations	When used as a master station	61*2	
	When used as a local station	121	
Station-based data assurance	When used as a master station	61*2	
	When used as a local station	121	
Connection cable		For details, refer to MELSEC iQ-F FX5 User's Manual (CC-Link IE TSN).	
Overall cable distance	Line topology	12000 m (when 121 stations are connected)	
	Others	Depends on the system configuration.	
Maximum station-to-station distance		100 m	
Network number setting range		1 to 239	
Network topology		Line topology, star topology (coexistence of line topology and star topology is also possible)	
Communication method		Time sharing method	
Multicast filter		Supported	
Transient transmission capacity		1920 bytes	
Compatible CPU module		FX5U, FX5UC: Ver. 1.210 or later Connection with FX5UC CPU module requires connector conversion module (FX5-CNV-IFC) or extension power supply module (FX5-C1PS-5V).	
Applicable engineering tool		FX5U, FX5UC: GX Works3 Ver. 1.065T or later	
Number of occupied I/O points		8 points (Either input or output is available for counting.)	
Number of connectable modules		Only 1 module can be connected to CPU module for each station type <ul style="list-style-type: none"> • Master station: 1 module • Local station: 1 module 	
Power supply		24 V DC 220 mA (external power supply)	
External dimensions W × H × D (mm)		50 × 90 × 83	
MASS (Weight): kg		Approx. 0.3	

◆ Network topology

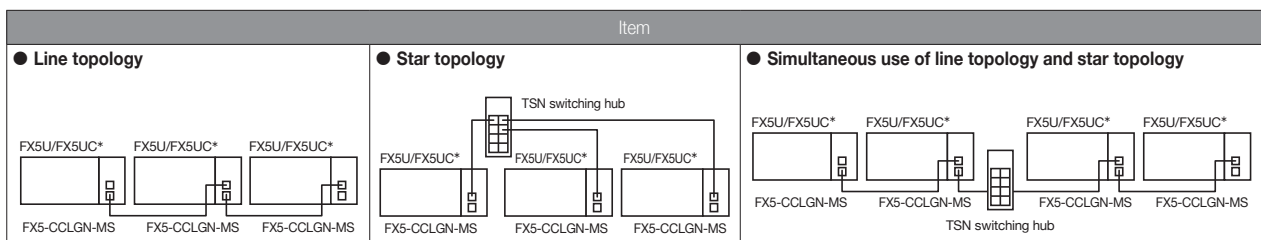

*: Connection with FX5UC CPU module requires connector conversion module (FX5-CNV-IFC) or extension power supply module (FX5-C1PS-5V).

CC-Link IE Field

CC-Link IE Field

CC-Link IE Field is a high-speed (1 Gbps), high capacity open field network using Ethernet (1000BASE-T).
 FX5-CCLIEF is an intelligent function module to connect the FX5 CPU module as an intelligent device station to a CC-Link IE Field Network.

FX5-CCLIEF intelligent device station for CC-Link IE Field network

◆ Features



MELSEC iQ-F Series modules can be connected as intelligent device stations in the CC-Link IE Field network.

◆ Specifications

Items		Specifications
Station type		Intelligent device station
Station number		1 to 120 (set by parameter or program)
Communication speed		1 Gbps
Network topology		Line topology, star topology (coexistence of line topology and star topology is also possible), and ring topology
Maximum station-to-station distance		100 m (conforms to ANSI/TIA/EIA-568-B (Category 5e))
Cascade connection		Max. 20 stages
Communication method		Token passing
Maximum number of link points*1	RX	384 points, 48 bytes
	RY	384 points, 48 bytes
	RWr	1024 points, 2048 bytes*2
	RWw	1024 points, 2048 bytes*2
Compatible CPU module		FX5UJ: Compatible from initial product FX5U, FX5UC: Ver. 1.030 or later Connection with FX5UC CPU module requires connector conversion module (FX5-CNV-IFC) or extension power supply module (FX5-C1PS-5V).
Applicable engineering tool		FX5UJ: GX Works3 Ver. 1.060N or later FX5U, FX5UC: GX Works3 Ver. 1.025B or later
Number of occupied I/O points		8 points (Either input or output is available for counting.)
Communication with PLC		Done by FROM/TO instruction via buffer memory (buffer memory can be directly specified)
Number of connectable modules		FX5UJ, FX5U, FX5UC: Max. 1 module
Power supply		5 V DC 10 mA (internal power supply) 24 V DC 230 mA (external power supply)
External dimensions W × H × D (mm)		50 × 90 × 103
MASS (Weight): kg		Approx. 0.3

*1: The maximum number of link points that a master station can assign to one FX5-CCLIEF module.
 *2: 256 points (512 bytes) when the mode of the master station is online (High-Speed Mode).

◆ Network topology

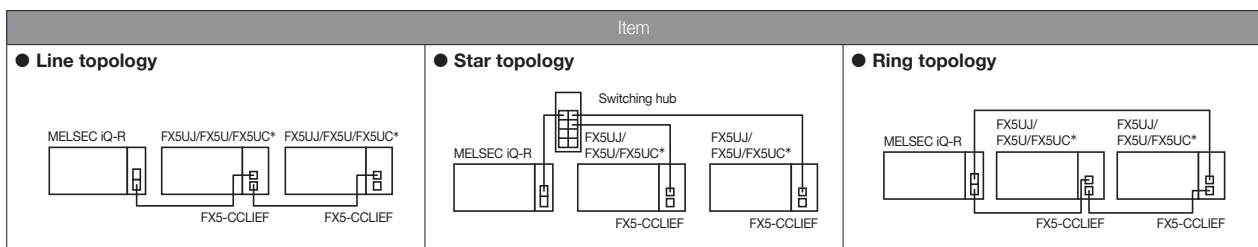

*: Connection with FX5UC CPU module requires connector conversion module (FX5-CNV-IFC) or extension power supply module (FX5-C1PS-5V).

CC-Link V2

CC-Link V2 is an open network enabling connection of various FA equipment.
 A master module to set MELSEC iQ-F Series as CC-Link master, as well as an interface to connect as a CC-Link slave are available.

FX5-CCL-MS type CC-Link system master/intelligent device module

◆ Features



- 1) Since this module has both functions, the master station and intelligent device station, it can be used as either of them by switching with parameters.
- 2) When FX5U/FX5UC CPU module is used, parameters from the program can be set*1.
- 3) When using the module as an intelligent device station, the transmission speed can be set to auto-tracking. Since the module tracks the transmission speed of the master station automatically, there is no setting mistake.
- 4) Supporting the other station access function, the module can use GX Works3 connected to the local station to monitor program writing and reading and devices of PLCs of other stations in the same network. This function thus eliminates the need for connecting GX Works3 to individual MELSEC iQ-F series and reduces man-hours.

◆ Specifications

Item		Specifications										
Compatible functions		Master station or intelligent device station										
CC-Link supported version		Ver. 2.00 and Ver. 1.10										
Transmission Speed		<ul style="list-style-type: none"> • Master station: 156 kbps/625 kbps/2.5 Mbps/5 Mbps/10 Mbps • Intelligent device station: 156 kbps/625 kbps/2.5 Mbps/5 Mbps/10 Mbps/auto-tracking 										
Station number		<ul style="list-style-type: none"> • Master station: 0 • Intelligent device station: 1 to 64 										
Connectable station type (at the time of master station)		Remote I/O station, remote device station, intelligent device station (local station and standby master station cannot be connected)										
Maximum overall cable length		1200 m (varies depending on transmission speed)										
Maximum number of connected stations (at the time of master station)		<ul style="list-style-type: none"> ■ FX5UJ CPU module • Remote I/O stations: 6 maximum (The total number of I/O points of remote I/O station is 192 or less.) • The total number of intelligent device stations + remote device stations: 8 maximum (The total number of I/O points of intelligent device station + remote device station is 256 or less.) ■ FX5U/FX5UC CPU module*2 • Remote I/O stations: 14 maximum (The total number of I/O points of remote I/O station is 448 or less.) • The total number of remote device stations + intelligent device stations: 14 maximum (The total number of I/O points of intelligent device station + remote device station is 448 or less.) 										
Number of occupied stations (at the time of intelligent device station)		1 to 4 stations										
Maximum number of link points per system*2	CC-Link Ver. 1	<ul style="list-style-type: none"> ■ FX5UJ CPU module • Remote I/O (RX, RY): 448 points (remote I/O station: 192 points*3 + remote device stations and intelligent device stations: 256 points) • Remote register (RWw): 32 points • Remote register (RWr): 32 points ■ FX5U/FX5UC CPU module*2 • Remote I/O (RX, RY): 896 points (remote I/O station: 448 points*3 + remote device stations and intelligent device stations: 448 points) • Remote register (RWw): 56 points • Remote register (RWr): 56 points 										
	CC-Link Ver. 2	<ul style="list-style-type: none"> ■ FX5UJ CPU module • Remote I/O (RX, RY): 448 points (remote I/O station: 192 points*3 + remote device stations and intelligent device stations: 256 points) • Remote register (RWw): 64 points • Remote register (RWr): 64 points ■ FX5U/FX5UC CPU module*2 • Remote I/O (RX, RY): 896 points (remote I/O station: 448 points*3 + remote device stations and intelligent device stations: 448 points) • Remote register (RWw): 112 points • Remote register (RWr): 112 points 										
Number of link points*2	Extended cyclic setting	CC-Link Ver. 1		CC-Link Ver. 2								
				Single		Double		Quadruple		Octuple		
	Number of occupied stations		Remote I/O	Remote register	Remote I/O	Remote register	Remote I/O	Remote register	Remote I/O	Remote register	Remote I/O	Remote register
	1 station occupied		RX, RY: 32 points (16 points)*4	RWw: 4 points RWr: 4 points	RX, RY: 32 points (16 points)*4	RWw: 4 points RWr: 4 points	RX, RY: 32 points (16 points)*4	RWw: 8 points RWr: 8 points	RX, RY: 64 points (48 points)*4	RWw: 16 points RWr: 16 points	RX, RY: 128 points*5 (112 points)*4*5	RWw: 32 points*5 RWr: 32 points*5
	2 stations occupied		RX, RY: 64 points (48 points)*4	RWw: 8 points RWr: 8 points	RX, RY: 64 points (48 points)*4	RWw: 8 points RWr: 8 points	RX, RY: 96 points (80 points)*4	RWw: 16 points RWr: 16 points	RX, RY: 192 points (176 points)*4	RWw: 32 points RWr: 32 points	RX, RY: 384 points*5 (368 points)*4*5	RWw: 64 points*5 RWr: 64 points*5
	3 stations occupied		RX, RY: 96 points (80 points)*4	RWw: 12 points RWr: 12 points	RX, RY: 96 points (80 points)*4	RWw: 12 points RWr: 12 points	RX, RY: 160 points (144 points)*4	RWw: 24 points RWr: 24 points	RX, RY: 320 points*5 (304 points)*4*5	RWw: 48 points*5 RWr: 48 points*5	/	/
4 stations occupied		RX, RY: 128 points (112 points)*4	RWw: 16 points RWr: 16 points	RX, RY: 128 points (112 points)*4	RWw: 16 points RWr: 16 points	RX, RY: 224 points (208 points)*4	RWw: 32 points RWr: 32 points	RX, RY: 448 points*5 (-)*4*5	RWw, RWr: 64 points*5 (-)*4*5	/	/	
Transmission cable		CC-Link Ver. 1.10 compatible CC-Link dedicated cable										

Item	Specifications
Compatible CPU module	FX5UJ: Compatible from initial product FX5U, FX5UC: Ver. 1.050 or later Connection with FX5UC CPU module requires connector conversion module (FX5-CNV-IFC) or extension power supply module (FX5-C1PS-5V).
Applicable engineering tool	FX5UJ: GX Works3 Ver. 1.060N or later FX5U, FX5UC: GX Works3 Ver. 1.035M or later*1
Communication method	Broadcast polling method
Transmission format	HDLC compliant
Error control system	CRC ($X^{16} + X^{12} + X^5 + 1$)
Number of occupied I/O points	8 points (Either input or output is available for counting.)
Number of connectable modules	Only 1 module can be connected to CPU module for each station type • Master station: 1 module*6 • Intelligent device station: 1 module*7
Power supply	24 V DC +20%, -15% 100 mA (external power supply)
Accessories	FX2NC-100MPCB type power cable (1 m, 3-wire) Ver. 1.10 compatible CC-Link dedicated cable terminating resistor (2) 110 Ω 1/2 W (color code: brown, brown, brown) Dust proof protection sheet (1)
External dimensions W x H x D (mm)	50 x 90 x 83
MASS (Weight): kg	Approx. 0.3

- *1: To set the parameters from the buffer memory via the program in the FX5U/FX5UC CPU module, GX Works3 of Ver. 1.065T or later is required.
- *2: Number of links with FX5U/FX5UC CPU module Ver. 1.100 or later. GX Works3 Ver. 1.047Z or later required. For details on the number of links with FX5U/FX5UC CPU module earlier than Ver. 1.100, refer to the following manual.
→ MELSEC iQ-F FX5 User's Manual (CC-Link)
- *3: The number of remote I/O points that can be used with the CPU module varies depending on the number of input/output points of the extension device.
For the limit of the number of I/O points, refer to the following manual.
→ MELSEC iQ-F FX5UJ User's Manual (Hardware)
→ MELSEC iQ-F FX5U User's Manual (Hardware)
→ MELSEC iQ-F FX5UC User's Manual (Hardware)
- *4: The numbers in parentheses are the points that can be used when the module is an intelligent device station.
- *5: Not applicable to the FX5UJ CPU module. For details, refer to the following manual.
→ MELSEC iQ-F FX5 User's Manual (CC-Link)
- *6: When using the FX5-CCL-MS as the master station, it cannot be used together with the FX3U-16CCL-M.
- *7: When using the FX5-CCL-MS as the intelligent device station, it cannot be used together with the FX3U-64CCL.

CC-Link master block FX3U-16CCL-M

◆ Features



- 1) A master module setting MELSEC iQ-F Series as master station of CC-Link.
- 2) Up to 8 remote I/O stations and up to 8 remote device stations or intelligent device stations can be connected to a master station.

◆ Specifications

Items		Specifications											
Supported functions		Master station function (No local station and standby master station functions)											
CC-Link compatible version		Ver. 2.00 compliance (Ver. 1.10 compatible at the time of setting extension cyclic to 1 time)											
Transmission speed		156 kbps/625 kbps/2.5 Mbps/5 Mbps/10 Mbps (setting by a rotary switch)											
Station No.		0 (setting by a rotary switch)											
Connectable station type		Remote I/O station, remote device station, intelligent device station (local station and standby master station cannot be connected)											
Max. cable extension length		1,200 m (varies depending on the transmission speed.)											
Max. no. of connection stations		Max. 16 stations • Remote I/O stations: 8 maximum (Each station occupies 32 I/O points of the PLC.) • Remote device stations + Intelligent device stations: 8 maximum (The total number of RX/Ry points is 256 or less.)											
Max. no of I/O points per system		[FX5U/FX5UC] The total connectable no. of (1) + (2) points below is 512 or less. (1) (No. of PLC actual I/O points) + (No. of occupied intelligent function module points) + (Occupied FX3U-16CCL-M points: 8 points) ≤ 256 (2) (32 × No. of remote I/O stations) ≤ 256											
		CC-Link Ver. 1.10					CC-Link Ver. 2.00						
Extension cyclic setting		—											
No. of occupied stations		Remote I/O		Remote register		Remote I/O		Remote register		Remote I/O		Remote register	
One station occupied		RX: 32 points RY: 32 points	RWw: 4 points RWr: 4 points	RX: 32 points RY: 32 points	RWw: 4 points RWr: 4 points	RX: 32 points RY: 32 points	RWw: 8 points RWr: 8 points	RX: 64 points RY: 64 points	RWw: 16 points RWr: 16 points	RX: 128 points RY: 128 points	RWw: 32 points RWr: 32 points		
Two stations occupied		RX: 64 points RY: 64 points	RWw: 8 points RWr: 8 points	RX: 64 points RY: 64 points	RWw: 8 points RWr: 8 points	RX: 96 points RY: 96 points	RWw: 16 points RWr: 16 points	RX: 192 points RY: 192 points	RWw: 32 points RWr: 32 points				
Three stations occupied		RX: 96 points RY: 96 points	RWw: 12 points RWr: 12 points	RX: 96 points RY: 96 points	RWw: 12 points RWr: 12 points	RX: 160 points RY: 160 points	RWw: 24 points RWr: 24 points						
Four stations occupied		RX: 128 points RY: 128 points	RWw: 16 points RWr: 16 points	RX: 128 points RY: 128 points	RWw: 16 points RWr: 16 points	RX: 224 points RY: 224 points	RWw: 32 points RWr: 32 points						
Transmission cable		CC-Link specific cable, CC-Link specific high-performance cable, Ver. 1.10 compatible CC-Link specific cable											
RAS function		Automatic return function, slave separating function, abnormal detection by link special relay/register, slave station refresh/Forced clear settings at the time of PLC CPU stop, cyclic data consistency function, and Consistency control function											
Compatible CPU module		FX5U, FX5UC: Compatible from initial product Connection with FX5U/FX5UC CPU module requires bus conversion module (FX5-CNV-BUS or FX5-CNV-BUSC).											
No. of occupied I/O points		8 points (Either input or output is available for counting.)											
Communication with PLC		Done by FROM/TO instruction via buffer memory (buffer memory can be directly specified)											
No. of connectable modules		FX5U, FX5UC: Max. 1 module*											
External power supply		Power supply voltage/ Current consumption 24 V DC +20%/-15% ripple (p-p) within 5% (Electricity supplied from terminal block for power supply)/240 mA											
Accessories		Terminal resistors • For standard cable: 110 Ω 1/2 W (Color code, brown/brown/brown) 2 pcs. • For high-performance cable: 130 Ω 1/2 W (Color code, brown/orange/brown) 2 pcs. Special block No. label											
External dimensions W × H × D (mm)		55 × 90 × 87											
MASS (Weight): kg		Approx. 0.3											

*: When using the FX3U-16CCL-M, it cannot be used together with the FX5-CCL-MS used as the master station.

◇ Example of system configuration with FX5U

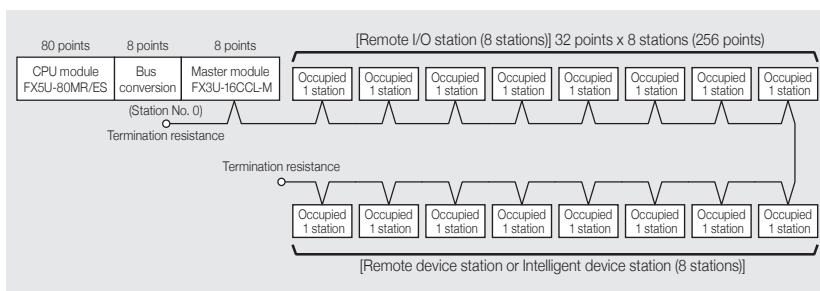

The maximum number of remote I/O stations to be connected is 8 when connecting 80-point type CPU module and FX3U-16CCL-M. The maximum number of remote I/O stations to be connected is less than 8 when the total number of points exceeds the maximum I/O points (512 points) due to the connection of I/O modules and intelligent function modules.

CC-Link interface block FX3U-64CCL

◇ Features



MELSEC iQ-F Series can be connected as intelligent device stations of CC-Link.

◇ Specifications

Items		Specifications							
Isolation method		Photocoupler							
CC-Link compatible version		Ver. 2.00 (Ver. 1.10 compliance at the time of setting extension cyclic to 1 time; Buffer memory FX2N-32CCL compatibility also selectable)							
Station types		Intelligent device station							
Station No.		1 to 64 (setting by a rotary switch)							
No. of occupied stations/ Extension cyclic setting		Occupied 1 to 4 stations, set to 1 to 8 times (setting by a rotary switch). Refer to the table below for the details of allowable range.							
Transmission speed		156 kbps/625 kbps/2.5 Mbps/5 Mbps/10 Mbps (setting by a rotary switch)							
Transmission cable		Ver. 1.10 compatible CC-Link specific cable, CC-Link specific high-performance cable							
		CC-Link Ver. 1.10				CC-Link Ver. 2.00			
No. of link points	Extension cyclic setting	Single		Double		Quadruple		Octuple	
	No. of occupied stations*1	Remote I/O	Remote register	Remote I/O	Remote register	Remote I/O	Remote register	Remote I/O	Remote register
	One station occupied	RX:32 points RY:32 points	RWw: 4 points RWr: 4 points	RX:32 points RY:32 points	RWw: 8 points RWr: 8 points	RX:64 points RY:64 points	RWw: 16 points RWr: 16 points	RX:128 points RY:128 points	RWw: 32 points RWr: 32 points
	Two stations occupied	RX:64 points RY:64 points	RWw: 8 points RWr: 8 points	RX:96 points RY:96 points	RWw: 16 points RWr: 16 points	RX:192 points RY:192 points	RWw: 32 points RWr: 32 points		
	Three stations occupied	RX:96 points RY:96 points	RWw: 12 points RWr: 12 points	RX:160 points RY:160 points	RWw: 24 points RWr: 24 points				
Four stations occupied	RX:128 points RY:128 points	RWw: 16 points RWr: 16 points	RX:224 points RY:224 points	RWw: 32 points RWr: 32 points					
Compatible CPU module		FX5U, FX5UC: Compatible from initial product Connection with FX5U/FX5UC CPU module requires bus conversion module (FX5-CNV-BUS or FX5-CNV-BUSC).							
No. of occupied I/O points		8 points (Either input or output is available for counting.)							
Communication with PLC		Done by FROM/TO instruction via buffer memory (buffer memory can be directly specified)							
No. of connectable modules		FX5U, FX5UC: Max. 1 module*2							
External power supply	Power supply voltage/ Current consumption	24 V DC +20%/-15% ripple (p-p) within 5% (Electricity supplied from terminal block for power supply)/220 mA							
External dimensions W x H x D (mm)		55 x 90 x 87							
MASS (Weight): kg		Approx. 0.3							

*1: RX/Ry for a high-order word of the last station of "Remote I/O" points is occupied as a system area.
*2: When using the FX3U-64CCL, it cannot be used together with the FX5-CCL-MS used as the intelligent device station.

Ethernet

Connecting FX5 to LAN (Local Area Network) via Ethernet enables various data communications and program maintenance.

● Outline of Functions

Simple CPU communication

Allows data communications between specified devices at the specified timing just by setting simple parameters from GX Works3.

Communication by SLMP

SLMP (SeamLess Message Protocol) can read/write the device data of PLC from the PC via the Ethernet communication.

Remote maintenance

Remote maintenance enables comfortable remote maintenance and monitoring. Realizes flexible maintenance using Internet regardless of where base is located!

VPN connection construction

VPN router: Relaying communication device by encrypting data

VPN (Virtual Private Network)*
This is a technology that connects networks by encrypting the communication contents. In combination with the Internet, VPN allows remotely separated networks to be accessed as if connected with each other via LAN.
*: A VPN connection service support partner will help you support VPN system construction.

Vision system

An image inspection device with a high cost performance can be configured by combining FX5U and EZ-700 series into an all-in-one system.

Main functions of Vision System

- Presence Inspection
- Burr Inspection
- Number Counting
- Fault Test
- Positioning
- Code Reading
- Dimensional Inspection
- Inclination Inspection
- Character Recognition, etc.
- Flaw/Stain Inspection
- Foreign Matter Inspection

Easy Builder

- Program
- Parameter setting

MELSOFT connection

The Ethernet-equipped module is connected to an engineering tool (GX Works3) without using a hub but only by one Ethernet cable. This connection communicates by only specifying the connection destination without setting an IP address.

- *1: IEEE802.3x flow control is not supported.
- *2: For maximum segment length (length between hubs), consult the manufacturer of the hub used.
- *3: Number of stages that can be connected when a repeater hub is used. When a switching hub is used, check the specifications of the switching hub used.
- *4: The first device for MELSOFT connection is not included in the number of connections. (The second and the following devices are included.)
- *5: The CC-Link IE Field Network Basic, FTP server, FTP client, SNTIP client, Web server and simple CPU communication function are not included in the number of connections.
- *6: The ports must comply with the IEEE802.3 100BASE-TX or IEEE802.3 10BASE-T standards.
- *7: If the first octet is 0 or 127, a parameter error (2222H) will occur. (Example: 0.0.0.0, 127.0.0.0, etc.)
- *8: A straight cable can be used. If a personal computer or GOT and CPU module are directly connected, a cross cable can be used.
- *9: Supported only by the FX5U/FX5UC CPU module.

Built-in Ethernet communication

◇ Features

- 1) The built-in Ethernet port can be used to connect to a PC or other device. In addition, the Ethernet communication port can handle seamless SLMP communication with the upper-level device.
- 2) Monitors and diagnoses the CPU module using a Web browser via connected network. Connect not only from a general-purpose browser on an Ethernet-connected PC but also from any general-purpose browser on a tablet or smartphone connected to an Ethernet network.

◇ Communication Specifications

Items	Specifications	
	FX5UJ/FX5U/FX5UC CPU module	
Data transmission speed	100/10 Mbps	
Communication mode	Full duplex/Half duplex*1	
Interface	RJ45 connector	
Transmission method	Base band	
Maximum segment length	100 m (length between hub and node)*2	
Cascade connection	100BASE-TX	Max. 2 stages*3
	10BASE-T	Max. 4 stages*3
Supported protocol	CC-Link IE Field Network Basic, MELSOFT connection, SLMP server (3E/1E*9 frame), socket communications, communication protocol support, FTP server, FTP client*9, MODBUS/TCP communication, SNTIP client, Web server (HTTP), simple CPU communication function	
No. of connections	Total of 8 connections**4*5 (Up to 8 external devices are accessible to one CPU module at a time.)	
Hub*1	A hub having 100BASE-TX or 10BASE-T port*6 can be used.	
IP address*7	Initial value: 192.168.3.250	
Circuit insulation	Pulse transformer insulation	
Cable used*8	When connecting 100BASE-TX	Ethernet cable of category 5 or higher (STP cable)
	When connecting 10BASE-T	Ethernet cable of category 3 or higher (STP cable)

FX5-ENET Ethernet module

◆ Features

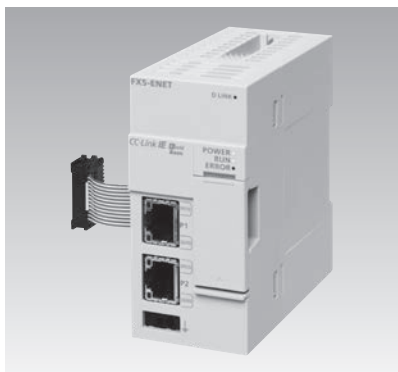

- 1) Master module for using the MELSEC iQ-F Series as a CC-Link IE Field Network Basic master station. Co-existence with general-purpose Ethernet is also possible.
- 2) Up to 32 connectable slave stations for CC-Link IE Field Network Basic, with control for up to 2048 link points for RX/Ry, and 1024 points for RWr/RWw within the same network.
- 3) Grouping of slave stations for CC-Link IE Field Network Basic with configuration of a group number, with cyclic transmission possible for each group. Grouping stations according to the slave station standard response time makes it possible to suppress the influence of differences in the standard response times of each slave station.
- 4) This module is compatible with general-purpose Ethernet communication, such as SLMP communication and socket communication.

◆ Specifications

Items		Specifications		
CC-Link IE Field Network Basic	Station type	Master station		
	Maximum number of connectable stations*1	32		
	Number of stations occupied by a slave station	1 to 4		
	Number of slave station groups	2		
	Maximum number of link points per network	RX	2048 points	
		Ry	2048 points	
		RWr	1024 points	
		RWw	1024 points	
	Maximum number of link points per station	Master station	RX	2048 points
			Ry	2048 points
			RWr	1024 points
			RWw	1024 points
		Slave station*2	RX	64/128/192/256 points
			Ry	64/128/192/256 points
			RWr	32/64/96/128 points
			RWw	32/64/96/128 points
	UDP port number used in the cyclic transmission	61450		
	UDP port number used in automatic detection of connected devices	Master station: An unused port number is assigned automatically. Slave station: 61451		
Transmission specifications	Data transfer speed	100 Mbps		
	Interface	RJ45 connector		
	Maximum station-to-station distance	100 m		
	Overall cable distance	Depends on the system configuration		
	Number of cascade connections	100BASE-TX When using a switching hub, check the number of cascaded stages with the manufacturer of the hub to be used.		
Network topology	Star topology			
Hub*3	Hubs with 100BASE-TX ports*4 can be used.			
Connection cable*5	100BASE-TX Ethernet cable of category 5 or higher (STP cable)			
General-purpose Ethernet communication	Transmission specifications	Data transfer speed	100/10 Mbps	
		Communication mode	Full-duplex or half-duplex*3	
		Transmission method	Base band	
		Interface	RJ45 connector	
		Maximum segment length	100 m (length between hub and node)*6	
		Number of cascade connections	100BASE-TX 2 levels maximum*7 10BASE-T 4 levels maximum*7	
	Supported protocol*8	MELSOFT connection, SLMP server (3E/1E frame), Socket communication, simple CPU communication, BACnet/IP		
	Number of connections	Total of 32 connections*9 (Up to 32 external devices can access one FX5-ENET module at the same time.)		
	Hub*3	Hubs with 100BASE-TX or 10BASE-T ports*10 can be used.		
	Connection cable*5	100BASE-TX Ethernet cable of category 5 or higher (STP cable) 10BASE-T Ethernet cable of category 3 or higher (STP/UTP cable)		
Number of ports	2*11			
Compatible CPU module	FX5UJ: Compatible from initial product FX5U, FX5UC: Ver. 1.110 or later Connection with FX5UC CPU module requires connector conversion module (FX5-CNV-IFC) or extension power supply module (FX5-C1PS-5V).			
Applicable engineering tool	FX5UJ: GX Works3 Ver. 1.060N or later*12 FX5U, FX5UC: GX Works3 Ver. 1.050C or later*12			
Number of occupied I/O points	8 points (Either input or output is available for counting.)			
Number of connectable modules	FX5UJ, FX5U, FX5UC: Up to 1 module			
Power supply	24 V DC, 110 mA (internal power supply)			
External dimensions W × H × D (mm)	40 × 90 × 83			
MASS (Weight): kg	Approx. 0.2			

Ethernet

- *1 : Maximum number of connected slave stations that FX5-ENET (master station) can manage. However, the maximum number of connectable modules varies depending on the number of stations occupied by a slave station.
- *2 : Value for 1-station occupation, 2-station occupation, 3-station occupation, or 4-station occupation.
- *3 : IEEE802.3x flow control is not supported.
- *4 : The ports must comply with the IEEE802.3 100BASE-TX standards.
- *5 : A straight/cross cable can be used.
- *6 : For maximum segment length (length between hubs), consult the manufacturer of the hub used.
- *7 : This number applies when a repeater hub is used. When using a switching hub, check the number of cascaded stages with the manufacturer of the hub to be used.
- *8 : For a compatible version of each protocol, refer to the following manual.
→ MELSEC iQ-F FX5-ENET User's Manual
- *9 : The first device for MELSOFT connection is not included in the number of connections. (The second and the following devices are included.)
The CC-Link IE field network Basic is not included in the number of connections.
- *10: The ports must comply with the IEEE802.3 100BASE-TX or IEEE802.3 10BASE-T standards.
- *11: Because the IP address is shared by two ports, only one address can be set.
- *12: To use the MELSOFT connection, SLMP communication, simple CPU communication, and BACnet/IP, GX Works3 of Ver. 1.075D or later is required.

EtherNet/IP

EtherNet/IP is a network using Ethernet.

Standard Ethernet is used, so general-purpose Ethernet can be used simultaneously.

FX5-ENET/IP Ethernet module

◆ Features



- 1) MELSEC iQ-F series module can be connected to the EtherNet/IP network. Coexistence with general-purpose Ethernet is also possible.
- 2) The EtherNet/IP communication parameters can be set with the dedicated setting tool (EtherNet/IP Configuration Tool for FX5-ENET/IP). The tool can be used not only to set the EtherNet/IP communication conditions, but also to detect EtherNet/IP devices on the network and set the EtherNet/IP communication conditions online.
- 3) Up to 32 modules can be connected to each of EtherNet/IP communication and general Ethernet communication networks.
- 4) This module is compatible with general-purpose Ethernet communication, such as SLMP communication and socket communication.

◆ Specifications

Items		Specifications	
EtherNet/IP communications	Class 1 communications	Communication format	Standard EtherNet/IP
		Number of connections	32
		Communication data size	1444 bytes (per connection)
		Connection type	Point-to-point, multicast
		RPI (communication cycle)	2 to 60000 ms
	Class 3 communications*1	Communication format	Standard EtherNet/IP
		Number of connections	32*2
		Connection type	Point-to-point
	UCMM communications	Communication format	Standard EtherNet/IP
		Number of connections (number of simultaneous executions)	32*2
		Communication data size	1414 bytes*3
	Transmission specifications	Connection type	Point-to-point
		Data transmission speed	100 Mbps
		Communication mode	Full-duplex
		Transmission method	Base band
		Interface	RJ45 connector
IP version		IPv4 is supported.	
Maximum segment length		100 m (length between hub and node)*4	
Number of cascade connections	100BASE-TX	2 levels maximum*5	
Network topology		Star topology, line topology	
Hub*6		Hubs with 100BASE-TX ports*7 can be used.	
Connection cable*8	100BASE-TX	Ethernet cable of category 5 or higher (STP cable)	
General-purpose Ethernet communication	Transmission specifications	Data transfer speed	100/10 Mbps
		Communication mode	Full-duplex or half-duplex*6
		Transmission method	Base band
		Interface	RJ45 connector
		Maximum segment length	100 m (length between hub and node)*4
	Number of cascade connections	100BASE-TX	2 levels maximum*5
		10BASE-T	4 levels maximum*5
	Protocol type*9		MELSOFT connection, SLMP server (3E/1E frame), socket communication, simple CPU communication, BACnet/IP
	Number of connections		Total of 32 connections*10 (Up to 32 external devices can access one FX5-ENET/IP module at the same time.)
	Hub*6		Hubs with 100BASE-TX or 10BASE-T ports*11 can be used.
Connection cable*8	100BASE-TX	Ethernet cable of category 5 or higher (STP cable)	
	10BASE-T	Ethernet cable of category 3 or higher (STP/UTP cable)	

Items	Specifications
Number of ports	2*12
Compatible CPU module	FX5UJ: Compatible from initial product FX5U, FX5UC: Ver. 1.110 or later Connection with FX5UC CPU module requires connector conversion module (FX5-CNV-IFC) or extension power supply module (FX5-C1PS-5V).
Applicable engineering tool	FX5UJ: GX Works3 Ver. 1.060N or later*13 FX5U, FX5UC: GX Works3 Ver. 1.050C or later*13 EtherNet/IP Configuration Tool for FX5-ENET/IP: Ver. 1.00A or later
Number of occupied I/O points	8 points (Either input or output is available for counting.)
Number of connectable modules	FX5UJ, FX5U, FX5UC: Up to 1 module
Power supply	24 V DC, 110 mA (internal power supply)
External dimensions W x H x D (mm)	40 x 90 x 83
MASS (Weight): kg	Approx. 0.2

- *1 : Class 3 communication supports the server functions.
- *2 : The total number of connections for Class 3 communications and UCMM communications is 32.
- *3 : This size is the maximum size which can be specified to 'Data length' of Class 1 communication input data area of the request command during the client operation.
During the sever operation, since the FX5-ENET/IP automatically responds according to the request command received from the client, the maximum size is not prescribed.
- *4 : For maximum segment length (length between hubs), consult the manufacturer of the hub used.
- *5 : This number applies when a repeater hub is used. When using a switching hub, check the number of cascaded stages with the manufacturer of the hub to be used.
- *6 : IEEE802.3x flow control is not supported.
- *7 : The ports must comply with the IEEE802.3 100BASE-TX standards.
- *8 : A straight/cross cable can be used.
- *9 : For a compatible version of each protocol, refer to the following manual.
→ MELSEC iQ-F FX5-ENET/IP User's Manual
- *10: The first device for MELSOFT connection is not included in the number of connections. (The second and the following devices are included.)
The CC-Link IE field network Basic is not included in the number of connections.
- *11: The ports must comply with the IEEE802.3 100BASE-TX or IEEE802.3 10BASE-T standards.
- *12: Since the IP address is shared by two ports, only one address can be set.
- *13: To use the MELSOFT connection, SLMP communication, simple CPU communication, and BACnet/IP, GX Works3 of Ver. 1.075D or later is required.

memo

MODBUS

FX5 can be connected to various MODBUS communication devices as master station or slave station of the MODBUS communication.

MODBUS RTU communication

◆ Features

- 1) Connection to 32 slave stations for RS-485 communication and one slave station for RS-232C communication is possible with a single master station.
- 2) Master function and slave functions are supported, and the master and slave can be used simultaneously by a single FX5. (However, only 1 channel can be used for the master station.)
- 3) Up to 4 channels*1 can be used for MODBUS serial communication function by one CPU module.

◆ System configuration example

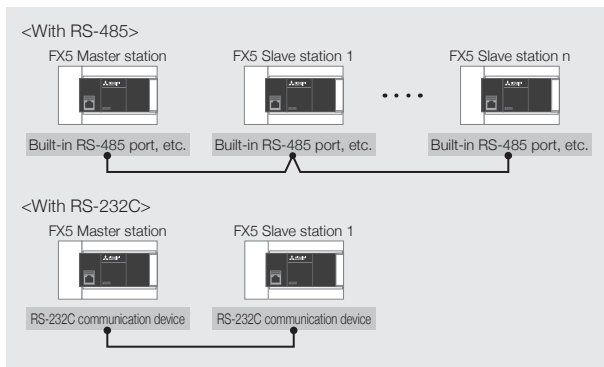

◆ Specifications

Item	Specifications	
	FX5U/FX5UC CPU module Built-in RS-485 port FX5-485-BD FX5-485ADP	FX5-232-BD FX5-232ADP
Number of connected modules	Up to 4 channels*1 (only 1 channel for the master)	
Communication Specifications	Communication interface	RS-485 / RS-232C
	Baud rate	300/600/1200/2400/4800/9600/19200/ 38400/57600/115200 bps
	Data length	8 bits
	Parity bit	None, odd or even
	Stop bit	1 bit/2 bits
	Transmission distance*2	1200 m or less when configured with FX5-485ADP only 50 m or less when configured other than the above
Master function	Communication protocol	RTU
	Number of connectable slaves*3	32 stations / 1 station
	Number of functions	8 (without diagnostic function)
	Number of simultaneous transmission messages	1 message
	Maximum number of writes	123 words or 1968 coils
Slave function	Maximum number of reads	125 words or 2000 coils
	Number of functions	8 (without diagnostic function)
	Number of messages that can be received simultaneously	1 message
Station number	1 to 247	

- *1: Available by either master or slave.
Maximum number of channels differs depending on the CPU module. For details, refer to the following manual.
→ MELSEC iQ-F FX5 User's Manual (MODBUS Communication)
- *2: The transmission distance varies depending on the type of communications equipment.
- *3: The number of slaves varies depending on the type of communications equipment.

MODBUS/TCP communication

◆ Features

- 1) Communication is possible, via Ethernet connection, with various MODBUS/TCP master devices connected to the FX5 set as the slave station.
- 2) Master function and slave functions are supported, and the master and slave can be used simultaneously by a single FX5.
- 3) Up to 8 connections can be used for MODBUS/TCP communication function by one CPU module.
- 4) The master uses a predefined protocol support function and controls the slave.

◆ System configuration example

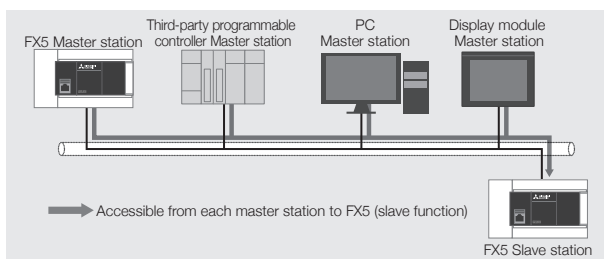

◆ Specifications

For communication specification other than the followings, refer to the MELSEC iQ-F FX5 User's Manual (Ethernet Communication).

Items		Specifications
Supported protocol		MODBUS/TCP (Binary only supported)
Number of connections		Total of 8 connections*1 (Up to 8 external devices can access one CPU module at the same time.)
Slave function	Number of functions	10
	Port station No.	502*2

- *1: The number of available connections decreases when the other Ethernet communication function is used. However, the first MELSOFT connection, CC-Link IE Field Network Basic, FTP server, FTP client, SNMP client, and Web server are not included in the number of connections (The second and subsequent MELSOFT connections are included). For details on the Ethernet communication function, refer to the following manual.
→ MELSEC iQ-F FX5 User's Manual (Ethernet Communication)
- *2: The port station No. can be changed by the communication setting.

Sensor Solution

Sensor wire-saving system of AnyWireASLINK is easily configurable.

FX5-ASL-M type AnyWireASLINK system master module

◇ Features



- 1) The AnyWireASLINK system can centrally monitor the status of sensors from the PLC and perform disconnection/short-circuit detection, sensor sensitivity setting, status monitoring, etc. It has no restriction on minimum distance between terminals. Any wiring method, such as T-branch, multi-drop, and star, can be used, and it can be flexibly branched and connected.
- 2) Since the status of the sensor can be monitored from the PLC, it is possible to predict the occurrence of troubles such as a decrease in the amount of light received by the sensor and prevent the production line from stopping in advance.
- 3) ID (address) can be changed from the buffer memory for one slave module without using the address writer. A slave ID can be changed even from a remote location.*

*: For the slave modules compatible with the remote address change function, contact Anywire Corporation.

◇ Safety precautions

FX5-ASL-M is jointly developed and manufactured with Anywire Corporation. Note that the warranty for this product differs from the ones for other PLC products.

For details of warranty and specifications, refer to the manual.

◇ Specifications

Item	Specifications
Transmission clock	27.0 kHz
Maximum transmission distance (total extension distance)	200 m*1
Transmission system	DC power supply superimposed total frame/cyclic system
Connection type	Bus type (multi-drop method, T-branch method, tree branch method)
Transmission protocol	Dedicated protocol (AnyWireASLINK)
Error control	Checksum, double check method
Number of connected I/O points	<ul style="list-style-type: none"> • FX5UJ: Up to 216 points*2 (192 input points maximum/192 output points maximum) • FX5U, FX5UC: Up to 448 points*2*3 (256 input points maximum/256 output points maximum)
Number of connected modules	Up to 128 modules (the number varies depending on the current consumption of each slave module)
Maximum number of I/O points per system	Number of slave module input points + number of slave module output points ≤ 384 points
External interface	7-piece spring clamp terminal block push-in type
RAS function	<ul style="list-style-type: none"> • Transmission line disconnection position detection function • Transmission line short-circuit detection function • Transmission power drop detection function
Transmission line (DP, DN)	UL compatible general-purpose 2-wire cable (VCTF, VCT 1.25 mm ² , 0.75 mm ² , temperature rating 70°C or higher) UL compatible general-purpose cable (1.25 mm ² , 0.75 mm ² , temperature rating 70°C or higher) Dedicated flat cable (1.25 mm ² , 0.75 mm ² , temperature rating 90°C)
Power cable (24 V, 0 V)	UL compatible general-purpose 2-wire cable (VCTF, VCT 0.75 to 2.0 mm ² , temperature rating 70°C or higher) UL compatible general-purpose power cable (0.75 to 2.0 mm ² , temperature rating 70°C or higher) Dedicated flat cable (1.25 mm ² , 0.75 mm ² , temperature rating 90°C)
Memory	Built-in EEPROM (Number of times of overwrite : 100000 times)
Compatible CPU module	FX5UJ: Compatible from initial product FX5U, FX5UC: Ver. 1.050 or later Connection with FX5UC CPU module requires connector conversion module (FX5-CNV-IFC) or extension power supply module (FX5-C1PS-5V).
Applicable engineering tool	FX5UJ: GX Works3 Ver. 1.060N or later FX5U, FX5UC: GX Works3 Ver. 1.035M or later
Power supply	5 V DC, 200 mA (internal power supply) 24 V DC -10%, +15% 100 mA (external power supply)
Number of occupied I/O points	8 points (Either input or output is available for counting.)
Number of connectable modules	FX5UJ, FX5U, FX5UC: Max. 1 module*4
External dimensions W × H × D (mm)	40 × 90 × 97.3
MASS (Weight): kg	Approx. 0.2

*1: For the slave module in which the transmission line (DP, DN) and module body are integrated, the length of the transmission line (DP, DN) is also included in the total extension.
When laying a 4-wire (DP, DN, 24 V, 0 V) line for fifty meters or more, insert a power line noise filter between the power supply and the line.
For details, refer to the manual of ASLINK filter (ANF-01) made by Anywire Corporation.

*2: The number of remote I/O points that can be used CPU module varies depending on the number of input/output points of the extension device.
For the limit of the number of I/O points, refer to the following manual.
→ MELSEC iQ-F FX5UJ User's Manual (Hardware)
→ MELSEC iQ-F FX5U User's Manual (Hardware)
→ MELSEC iQ-F FX5UC User's Manual (Hardware)

*3: Supported by FX5U/FX5UC CPU module Ver. 1.100 or later and by GX Works3 Ver. 1.047Z or later.

*4: Use together with the FX3U-128ASL-M is not possible.

FX3U-128ASL-M type AnyWireASLINK system master block

◇ Characteristics



- 1) A master module enables MELSEC iQ-F series to be connected to the AnyWireASLINK sensor wire-saving system of Anywire Corporation.
- 2) FX3U-128ASL-M type AnyWireASLINK system master module has a proprietary AnyWire transmission system including a power supply (equivalent to 24 V DC, MAX. 2 A) as a transmission signal, and thus realizes save wiring up to 200 m with a 4-core or 2-core cable.
- 3) When using ASLINKAMP or ASLINKSENSOR, settings can be changed by a ladder program, engineering tool or GOT. Set-up changes can be done remotely.

◇ Safety Precautions

FX3U-128ASL-M is jointly developed/ manufactured with Anywire Corporation. Guarantee details are different from other PLC products. Refer to manuals for guarantees/ specifications.

◇ Specifications

Items	Specifications
Transmission clock	27.0 kHz
Max. transmission distance (total extension length)	200 m
Transmission method	DC power supply superimposing total frame/cyclic method
Connection configuration	Bus type (Multi-drop method, T-branch method, tree branch method)
Transmission protocol	Dedicated protocol (AnyWireASLINK)
Error control	Double verification method, checksum
No. of connection I/O points	Max. 128 points
No. of connection modules	Max. 128 modules (variable depending on current consumption)
Max. no of I/O points per system	No. of input points of slave module + No. of output points of slave module ≤ 128 points
RAS function	<ul style="list-style-type: none"> • Transmission line disconnection position detection function • Transmission line short-circuit detection function • Transmission power drop detection function
AnyWireASLINK transmission line	UL supported general-use 2-line cable (VCTF, VCT 1.25 mm ² , 0.75 mm ² , rated temperature: 70°C or higher) UL supported general-use electric wire (1.25 mm ² , 0.75 mm ² , rated temperature: 70°C or higher), dedicated flat cable (1.25 mm ² , 0.75 mm ² , rated temperature: 90°C)
24 V DC power supply line	UL supported general-use 2-line cable (VCTF, VCT 0.75 to 2.0 mm ² , rated temperature: 70°C or higher) UL supported general-use electric wire (0.75 to 2.0 mm ² , rated temperature: 70°C or higher), dedicated flat cable (1.25 mm ² , 0.75 mm ² , rated temperature: 90°C)
Compatible CPU module	FX5U, FX5UC: Compatible from initial product Connection with FX5U/FX5UC CPU module requires bus conversion module (FX5-CNV-BUS or FX5-CNV-BUSC).
Power supply	5 V DC, 130 mA (internal power supply) 24 V DC -10% +15% 100 mA (AnyWireASLINK communication external power supply)
No. of occupied I/O points	8 points (Either input or output is available for counting.)
Communication with PLC	Done by FROM/TO instruction via buffer memory (buffer memory can be directly specified)
No. of connectable modules	FX5U, FX5UC: Max. 1 module*
External dimensions W x H x D (mm)	43 x 90 x 95.5
MASS (Weight): kg	Approx. 0.2

*: Use together with the FX5-ASL-M is not possible.

Your requests for reduced wiring, detecting of disconnection/short circuit, setting of sensor sensitivity, and status monitoring can be satisfied by MELSEC iQ-F.

Powered by **Anywire**

▶ **Example of system configuration (AnyWireASLINK)**

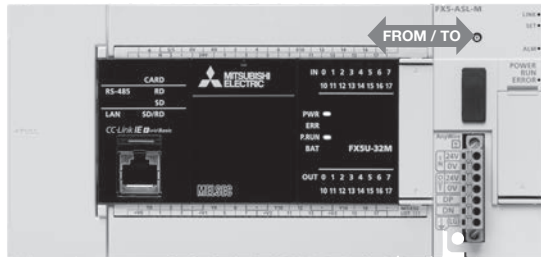

FX5-ASL-M

AnyWireASLINK sensor can be connected.

Detection of short circuit and disconnection, setting of sensor sensitivity, address automatic recognition

Total extension length of 200 m*1, Max. 448 points*3*4*5 and Max. 128 modules*2 connectable

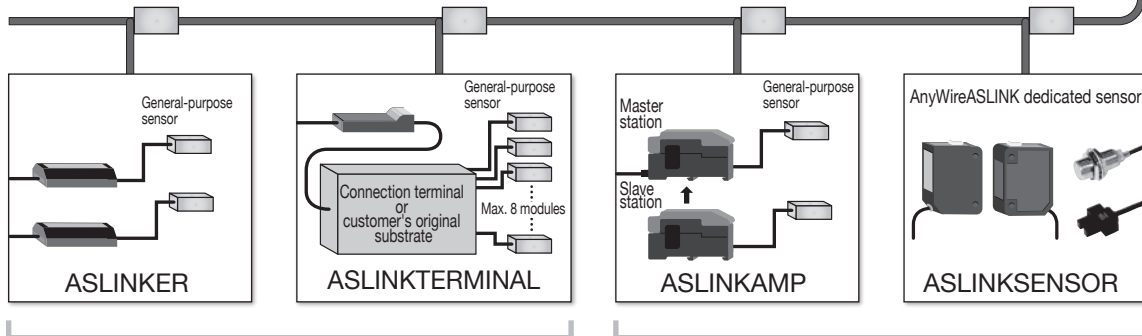

Sensor disconnection is detectable

Disconnection and short-circuit of sensors are detectable
Setting of sensor sensitivity or status monitoring are possible

AnyWireASLINK

Max. no. of I/O: 2 points

■ ASLINKER

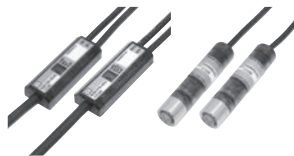

Cable lamp

Connector type

Max. no. of I/O: 8 points

■ ASLINKTERMINAL



8-point input terminal

8-point output terminal

General-purpose sensor head connection

■ ASLINKAMP



Max. 16 modules can be added.

Directly connected sensors

■ ASLINKSENSOR



Optical sensor

Proximity sensor

Photo interrupter

*1: Total extension distance including the portion of branch line.
 *2: Subject to change based upon current consumption of each slave module.
 *3: The number of remote I/O points that can be used with the CPU module varies depending on the number of input/output points of the extension device.
 For the limit of the number of I/O points, refer to the following manual.
 → MELSEC iQ-F FX5UJ User's Manual (Hardware)
 → MELSEC iQ-F FX5U User's Manual (Hardware)
 → MELSEC iQ-F FX5UC User's Manual (Hardware)
 *4: Supported by FX5U/FX5UC CPU module Ver. 1.100 or later and by GX Works3 Ver. 1.047Z or later.
 *5: FX5UJ CPU module: Up to 216 points.

PROFIBUS-DP

PROFIBUS is an industrial fieldbus developed and maintained by PROFIBUS & PROFINET International (PI). This protocol enables high-speed data transmission between field devices such as a remote I/O module or drive and a controller.

FX5-DP-M type PROFIBUS-DP master module

◆ Features



- 1) This master module is necessary for using the MELSEC iQ-F Series as a PROFIBUS-DP master station. Using this product makes it possible to incorporate compatible slave devices into the system.
- 2) Using the buffer memory makes it possible to obtain communications error information or extended communications error information generated by a slave station during I/O data transmission.
- 3) Settings can be configured with the following software:
 - GX Works3 (FX5UJ: Ver. 1.060N or later, FX5U/FX5UC: Ver. 1.050C or later)
 - PROFIBUS Configuration Tool (FX5UJ: Ver. 1.03D or later, FX5U/FX5UC: Ver. 1.02C or later)

◆ Specifications

Items		Specifications
PROFIBUS-DP station type		Class 1 master station
Electrical standard and characteristics		Compliant with EIA-RS485
Medium		Shielded twisted pair cable
Network configuration		Bus topology (or tree topology when repeaters are used)
Data link method		Between DP-Masters: Token passing Between DP-Master and DP-Slave: Polling
Encoding method		NRZ
Transmission speed*		9.6 kbps, 19.2 kbps, 93.75 kbps, 187.5 kbps, 500 kbps, 1.5 Mbps, 3 Mbps, 6 Mbps, 12 Mbps
Transmission distance		Differs depending on transmission speed
Maximum number of repeaters (Between DP-Master and DP-Slave)		3 repeaters
Number of connectable modules (per segment)		32 per segment (including repeaters)
Maximum number of DP-Slaves		64 modules
Number of connectable nodes (number of repeaters)		32, 62 (1), 92 (2), 122 (3), 126 (4)
Transmittable data	Input data	Max. of 2048 bytes (Max. of 244 bytes per DP-Slave)
	Output data	Max. of 2048 bytes (Max. of 244 bytes per DP-Slave)
Compatible CPU module		FX5UJ: Compatible from initial product FX5U, FX5UC: Ver. 1.110 or later Connection with FX5UC CPU module requires connector conversion module (FX5-CNV-IFC) or extension power supply module (FX5-C1PS-5V).
Applicable engineering tool		FX5UJ: GX Works3 Ver. 1.060N or later PROFIBUS Configuration Tool: Ver. 1.03D or later FX5U, FX5UC: GX Works3 Ver. 1.050C or later PROFIBUS Configuration Tool: Ver. 1.02C or later
Number of occupied I/O points		8 points (Either input or output is available for counting.)
Number of connectable modules		FX5UJ, FX5U, FX5UC: Up to 1 module
Power supply		24 V DC, 150 mA (internal power supply)
External dimensions W × H × D (mm)		40 × 90 × 85.3
MASS (Weight): kg		Approx. 0.2

*: Transmission speed accuracy is within ±0.2% (compliant with IEC61158-2).

FX3U-32DP PROFIBUS-DP interface block

◆ Features



Connectable as a MELSEC iQ-F Series slave station in PROFIBUS-DP systems.

◆ Specifications

Items		Specifications					
PROFIBUS-DP station type		PROFIBUS-DP slave station					
Transmission speed		9.6 kbps, 19.2 kbps, 45.45 kbps, 93.75 kbps, 187.5 kbps, 500 kbps, 1.5 Mbps, 3 Mbps, 6 Mbps, 12 Mbps					
Transmission distance/segment	Transmission speed	9.6 kbps,					
		19.2 kbps,					
		45.45 kbps,					
		93.75 kbps					
Transmission distance/segment	No repeaters	1,200 m	1,000 m	400 m	200 m	100 m	
	1 repeater	2,400 m	2,000 m	800 m	400 m	200 m	
	2 repeaters	3,600 m	3,000 m	1,200 m	600 m	300 m	
	3 repeaters	4,800 m	4,000 m	1,600 m	800 m	400 m	
Transmittable data		Up to 144 bytes Default: 32 bytes (cyclic input / cyclic output)					
PROFIBUS module ID		F332h					
Global control		Supports SYNC, UNSYNC, FREEZE, and UNFREEZE modes					
Compatible CPU module		FX5U, FX5UC: Compatible from initial product Connection with FX5U/FX5UC CPU module requires bus conversion module (FX5-CNV-BUS or FX5-CNV-BUSC).					
Number of occupied I/O points		8 points (Either input or output is available for counting.)					
Number of connectable modules		FX5U: Up to 8 modules*, FX5UC: Up to 6 modules					
Power supply		24 V DC, 145 mA (internal power supply)					
External dimensions W × H × D (mm)		43 × 90 × 89					
MASS (Weight): kg		Approx. 0.2					

*: When using FX3U-1PSU-5V. Up to 6 modules when not using FX3U-1PSU-5V.

General-purpose Communication Devices

Various communication functions can be added easily using an expansion board or expansion adapter. Communications with data link or external serial interface device can be realized easily by adding an expansion board.

Expansion board (for communication)

◆ Features



- 1) Communication expansion board can be added to FX5UJ/FX5U CPU module.
- 2) Communication function can be added inexpensively.

Refer to the following items for usage method of expansion board.

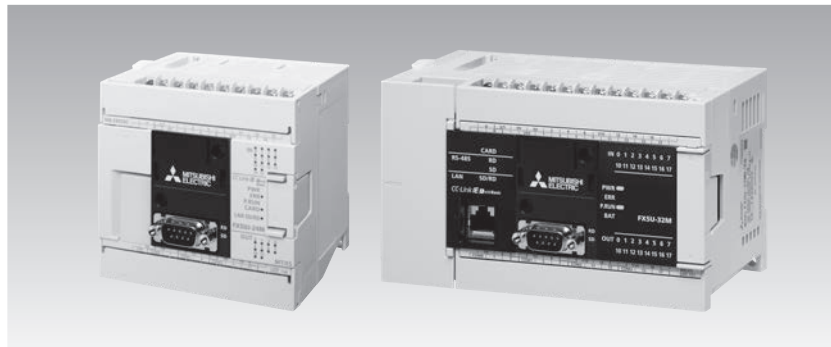
- "N:N network" • "Parallel link" • "MC protocol"
- "Non-protocol communication"
- "Connection to peripheral device"
- "Inverter communication function"



◆ Specifications

Model/Characteristics	Items	Specifications
FX5-232-BD RS-232C communication expansion board 	Transmission standard	Conforming to RS-232C standard
	Max. transmission distance	15 m
	External device connection method	9-pin D-sub (male)
	Insulation	Non-isolation (between communication line and CPU)
	Communication method	Half-duplex bidirectional/Full-duplex bidirectional*1
	Protocol type	MELSOFT connection, MC protocol (1C/3C/4C frame), non-protocol communication, MODBUS RTU communication, predefined protocol support
	Communication speed	300/600/1200/2400/4800/9600/19200/38400/57600/115200 (bps)*1
	Terminal resistors	—
	Power supply	5 V DC, 20 mA (internal power supply)*2
	Compatible CPU module	FX5UJ, FX5U CPU module
	No. of occupied I/O points	0 points (no occupied points)
	External dimensions W × H × D (mm)	38 × 51.4 × 18.2
MASS (Weight): kg	Approx. 0.02	
FX5-485-BD RS-485 communication expansion board 	Transmission standard	Conforming to RS-485 and RS-422 standards
	Max. transmission distance	50 m
	External device connection method	European-type terminal block
	Insulation	Non-isolation (between communication line and CPU)
	Communication method	Half-duplex bidirectional/Full-duplex bidirectional*1
	Protocol type	MELSOFT connection, MC protocol (1C/3C/4C frame), non-protocol communication, MODBUS RTU communication, inverter communication, N:N network, parallel link, predefined protocol support
	Communication speed	300/600/1200/2400/4800/9600/19200/38400/57600/115200 (bps)*1
	Terminal resistors	Built in (OPEN/110 Ω/330 Ω)
	Power supply	5 V DC, 20 mA (internal power supply)*2
	Compatible CPU module	FX5UJ, FX5U CPU module
	No. of occupied I/O points	0 points (no occupied points)
	External dimensions W × H × D (mm)	38 × 51.4 × 30.5
MASS (Weight): kg	Approx. 0.02	
FX5-422-BD-GOT RS-422 communication expansion board (GOT connection) 	Transmission standard	Conforming to RS-422 standard
	Max. transmission distance	As per GOT specifications
	External device connection method	8-pin MINI-DIN (female)
	Insulation	Non-isolation (between communication line and CPU)
	Communication method	Half-duplex bidirectional
	Communication speed	9600/19200/38400/57600/115200 (bps)
	Terminal resistors	—
	Power supply	5 V DC, 20 mA (internal power supply)*2*3
	Compatible CPU module	FX5UJ, FX5U CPU module
	No. of occupied I/O points	0 points (no occupied points)
	External dimensions W × H × D (mm)	38 × 51.4 × 15.4
	MASS (Weight): kg	Approx. 0.02

*1: The communication method and communication speed vary depending upon the communication type.

*2: Current consumption calculation is not required for the FX5UJ CPU module.

*3: When the GOT 5V type is connected with this product, the power consumption increases. For the current consumption, refer to the manual of the model to be connected.

FX5-232ADP communication adapter is an expansion adapter for RS-232C communication

◆ Features

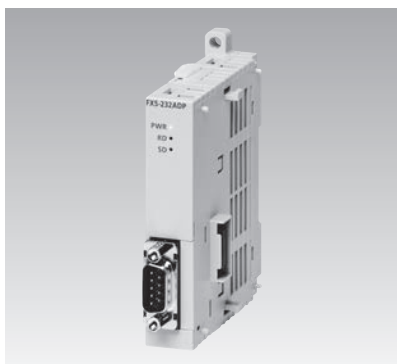

Insulation type RS-232C communication adapter
Refer to the "MC protocol", "Non-protocol communication", "Connection to peripheral device" for more details of functions.

◆ Specifications

Items	Specifications
Transmission standard	Conforming to RS-232C standard
Max. transmission distance	15 m
Insulation	Photocoupler (between communication line and CPU)
External device connection method: connector	9-pin D-sub (male)
Communication method	Half-duplex bidirectional/Full-duplex bidirectional
Protocol type	MELSOFT connection, MC protocol (1C/3C/4C frame), non-protocol communication, MODBUS RTU communication, predefined protocol support
Communication speed	300/600/1200/2400/4800/9600/19200/38400/57600/115200 (bps)*1
No. of occupied I/O points	0 points (no occupied points)
Current consumption (internal supply)	5 V DC 30 mA/24 V DC 30 mA
Compatible CPU module	FX5UJ, FX5U, FX5UC: Compatible from initial product
Number of connectable modules	FX5UJ, FX5U, FX5UC: Up to 2 communication adapters are provided on the left side of the CPU module.*2
External dimensions W × H × D (mm)	17.6 × 106 × 82.8
MASS (Weight): kg	Approx. 0.08

*1: The communication method and communication speed vary depending upon the communication type.

*2: For FX5UJ, when the expansion board is connected to the CPU module, up to one communication adapter can be connected.

FX5-485ADP communication adapter is an expansion adapter for RS-485 communication

◆ Features

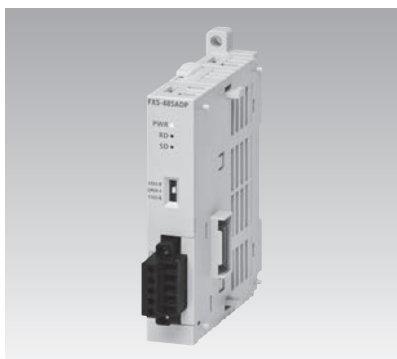

Insulation type RS-485 communication adapter
Refer to the "N:N network", "Parallel link", "MC Protocol", "Non-protocol communication", "Connection to peripheral device", "Inverter communication function" for more details of functions.

◆ Specifications

Items	Specifications
Transmission standard	Conforming to RS-485 and RS-422 standards
Max. transmission distance	1200 m
Insulation	Photocoupler (between communication line and CPU)
External device connection method	European-type terminal block
Communication method	Half-duplex bidirectional/Full-duplex bidirectional
Protocol type	MELSOFT connection, MC protocol (1C/3C/4C frame), non-protocol communication, MODBUS RTU communication, inverter communication, N:N network, parallel link, predefined protocol support
Communication speed	300/600/1200/2400/4800/9600/19200/38400/57600/115200 (bps)*1
Terminal resistors	Built in (OPEN/110 Ω/330 Ω)
No. of occupied I/O points	0 points (no occupied points)
Current consumption (internal supply)	5 V DC 20 mA/24 V DC 30 mA
Compatible CPU module	FX5UJ, FX5U, FX5UC: Compatible from initial product
Number of connectable modules	FX5UJ, FX5U, FX5UC: Up to 2 communication adapters are provided on the left side of the CPU module.*2
External dimensions W × H × D (mm)	17.6 × 106 × 89.1
MASS (Weight): kg	Approx. 0.08

*1: The communication method and communication speed vary depending upon the communication type.

*2: For FX5UJ, when the expansion board is connected to the CPU module, up to one communication adapter can be connected.

N:N Network

Data links can be easily configured among PLCs by using an RS-485 communication device.

RS-485 communication device

Model	Types	Compatible CPU module		
		FX5UJ	FX5U	FX5UC
FX5-485-BD	Expansion board	○	○	×
FX5-485ADP	Expansion adapter	○	○	○
—	Built-in RS-485 port	×	○	○

N:N network function

◆ Features

- 1) Data link can be realized by a simple program for connecting up to 8 modules of FX5 or FX3.
- 2) The bit device (0 to 64 points) and word device (4 to 8 points) are automatically linked between each station. The ON/OFF state of other stations and data register values can be obtained by the device allocated on the local station.

◆ System configuration example

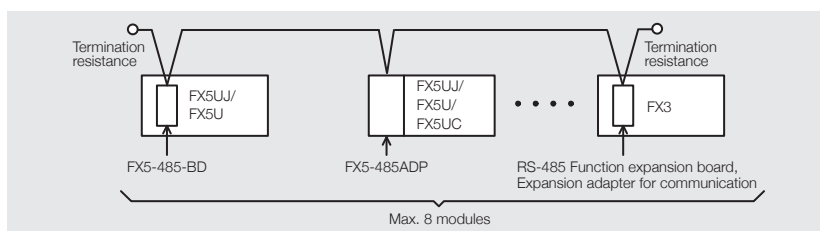

◆ Specifications of N:N network function

Items		Specifications
Transmission standard		Conforming to RS-485 standard
Total extension length		Configuration only using FX5-485ADP: 1200 m or less Configuration using FX5-485ADP, FX3U-485ADP(-MB): 500 m or less Configuration other than above: 50 m or less (at coexisting of built-in RS-485 port, FX5-485-BD and 485-BD for FX3: 50 m or less)
Communication method/Transmission speed		Half-duplex bidirectional, 38400 bps
No. of connectable modules		Max. 8 modules
No. of link points	Pattern 0	Bit device: 0 points Word device: 4 points
	Pattern 1	Bit device: 32 points Word device: 4 points
	Pattern 2	Bit device: 64 points Word device: 8 points
Link refresh time (ms)	Pattern 0	Based on the no. of connection modules, 2 modules (20), 3 modules (29), 4 modules (37), 5 modules (46), 6 modules (54), 7 modules (63), 8 modules (72)
	Pattern 1	Based on the no. of connection modules, 2 modules (24), 3 modules (35), 4 modules (45), 5 modules (56), 6 modules (67), 7 modules (78), 8 modules (88)
	Pattern 2	Based on the no. of connection modules, 2 modules (37), 3 modules (52), 4 modules (70), 5 modules (87), 6 modules (105), 7 modules (122), 8 modules (139)
Connection device with PLC	FX5UJ	FX5-485ADP, FX5-485-BD
	FX5U	FX5-485ADP, FX5-485-BD
	FX5UC	FX5-485ADP
	FX3S	FX3G-485-BD(-RJ) or FX3S-CNV-ADP+FX3U-485ADP(-MB)
	FX3G	FX3G-485-BD(-RJ) or FX3G-CNV-ADP+FX3U-485ADP(-MB)
	FX3GC	FX3U-485ADP(-MB)
FX3U, FX3UC*		FX3U-485-BD or Function expansion board+FX3U-485ADP(-MB)
Compatible CPU module		FX5UJ, FX5U, FX5UC, FX3S, FX3G, FX3GC, FX3U, FX3UC

*: Function expansion board cannot be connected to FX3UC-□□MT/D, FX3UC-□□MT/DSS, and FX3UC-16MR/D□-T. A special adapter can be connected directly.

Parallel Link

Devices can be mutually linked by connecting two FX5 CPU modules via an RS-485 communication device.

RS-485 communication equipment

Model name	Classification	Compatible CPU module		
		FX5UJ	FX5U	FX5UC
FX5-485-BD	Expansion board	○	○	×
FX5-485ADP	Expansion adapter	○	○	○
—	Built-in RS-485 port	×	○	○

Parallel link function

◆ Features

- 1) With 2 modules of FX5 CPU module connected, devices can be linked to each other only by parameter setting.
- 2) 2 types of link modes, normal parallel link mode and high-speed parallel link mode, can be selected according to the number of points you want to link to and the link time, and the data link is automatically updated between the 2 modules of FX5 CPU module.

◆ System configuration example

Parallel link

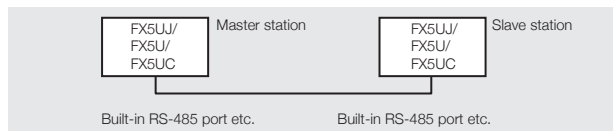

◆ Parallel link specifications

Item	Specifications
Number of connected modules	Up to 2 modules (1:1)
Transmission standards	RS-485 standard compliant
Maximum overall cable distance	1200 m or less when configured with FX5-485ADP only 50 m or less when configured other than the above
Link time	Normal parallel link mode: 15 ms + master station operation cycle (ms) + slave station operation cycle (ms) High-speed parallel link mode: 5 ms + master station operation cycle (ms) + slave station operation cycle (ms)

MC Protocol

Data link of multiple PLCs can be realized by setting a CPU module or external device as a master station using MC protocol (serial communication).

Since data link is done by command from the external device, it is suitable for configuration of data management and control system by the external device as the main controller.

RS-232C, RS-485 communication device

Model	Types	Compatible CPU module		
		FX5UJ	FX5U	FX5UC
FX5-232-BD	Expansion board	○	○	×
FX5-232ADP	Expansion adapter	○	○	○
FX5-485-BD	Expansion board	○	○	×
FX5-485ADP	Expansion adapter	○	○	○
—	Built-in RS-485 port	×	○	○

MC protocol function

◇ Features

- Using the RS-485 communication device enables connection of up to 16 modules of FX5 CPU module, and data can be transferred according to commands from the PC.
- Using the RS-232C communication device enables 1 : 1 data transfer with the PC.
- Communication by MC protocol A-compatible 1C frame and QnA-compatible-3C/4C frame is possible. (Type 1/Type 4/Type 5)

◇ System configuration example

- 1 : n connection using RS-485 communication

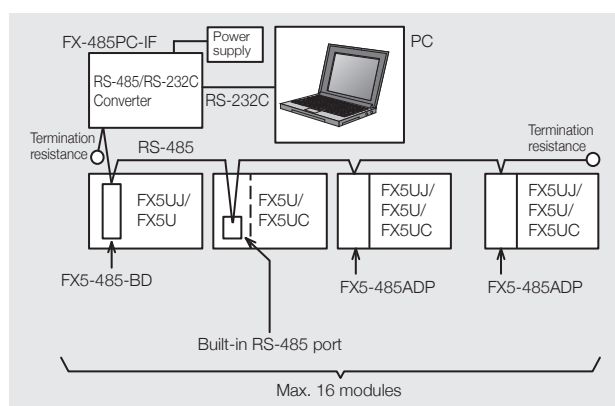

- 1 : 1 connection using RS-232C communication

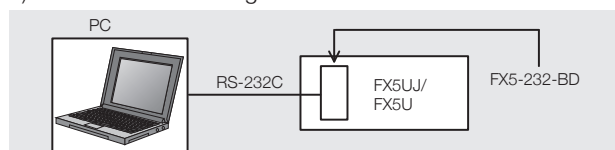

◇ MC protocol function specifications

Items		Specifications
Transmission standard		Conforming to RS-485/RS-232C standard
Total extension length	RS-485	When using FX5-485ADP: 1200 m or less When using the built-in RS-485 port or FX5-485-BD: 50 m or less
	RS-232C	15 m or less
Communication method		Half-duplex bidirectional
Transmission speed		300/600/1200/2400/4800/9600/19200/38400/57600/115200 bps
No. of connectable modules		Max. 16 modules
Protocol types		MC protocol (dedicated protocol) 1C/3C Frame (Type1/Type4) / 4C Frame (Type1/Type4/Type5)
RS-485 connection device	FX5UJ	FX5-485-BD or FX5-485ADP
	FX5U	Built-in RS-485 port, FX5-485-BD or FX5-485ADP
	FX5UC	Built-in RS-485 port or FX5-485ADP
RS-232C connection device	FX5UJ	FX5-232-BD or FX5-232ADP
	FX5U	FX5-232-BD or FX5-232ADP
	FX5UC	FX5-232ADP
Compatible CPU module		FX5UJ, FX5U, FX5UC



RS-232C/RS-485 Non-protocol Communication

MELSEC iQ-F Series modules can communicate with printers, code readers, measurement instruments, etc. having an interface in accordance with RS-232C/RS-485 (RS-422).

Communication is performed using sequence programs (RS2 instruction).

RS-232C communication

◇ RS-232C communication device

Model (No. of channels)	Communication method	Insulation	Maximum transmission distance	Control instruction	Compatible CPU module		
					FX5UJ	FX5U	FX5UC
FX5-232-BD (1 ch) 	Half-duplex bidirectional/ Full-duplex bidirectional	Non-isolation (between communication line and CPU)	15 m	RS2 instruction	○ (Max. 1 module)	○ (Max. 1 module)	×
FX5-232ADP (1 ch) 	Half-duplex bidirectional/ Full-duplex bidirectional	Photocoupler (between communication line and CPU)	15 m	RS2 instruction	○ (Max. 2 modules)	○ (Max. 2 modules)	○ (Max. 2 modules)

◇ Communication specification

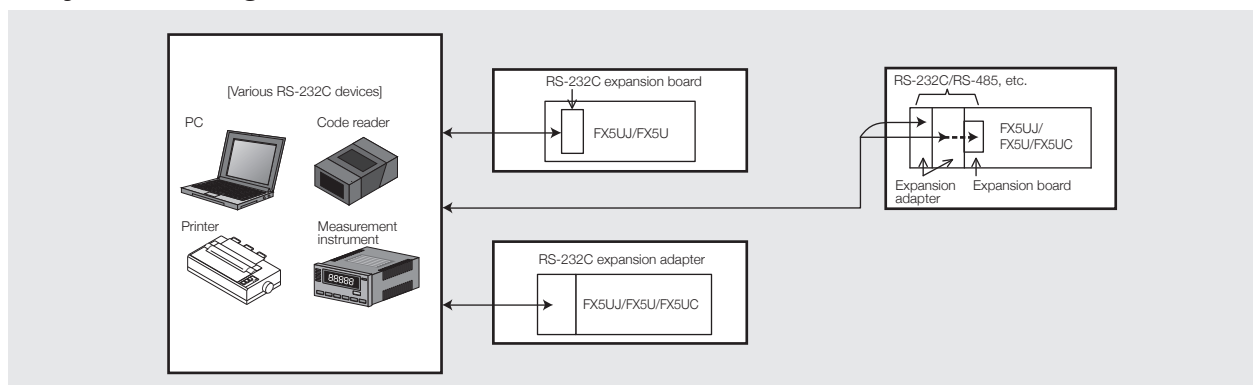

Refer to the specifications of each communication device for the details of RS-232C device specifications.

◇ System configuration



RS-485 (RS-422) communication

◇ RS-485 (RS-422) communication device

Model (No. of channels)	Communication method	Insulation	Maximum transmission distance	Control instruction	Compatible CPU module		
					FX5UJ	FX5U	FX5UC
FX5-485-BD (1 ch) 	Half-duplex bidirectional/ Full-duplex bidirectional	Non-isolation (between communication line and CPU)	50 m	RS2 instruction	○ (Max. 1 module)	○ (Max. 1 module)	×
FX5-485ADP (1 ch) 	Half-duplex bidirectional/ Full-duplex bidirectional	Photocoupler (between communication line and CPU)	1200 m	RS2 instruction	○ (Max. 2 modules)	○ (Max. 2 modules)	○ (Max. 2 modules)
Built-in RS-485 port (1 ch) 	Half-duplex bidirectional/ Full-duplex bidirectional	Non-isolation (between communication line and CPU)	50 m	RS2 instruction	×	○	○

◇ Communication specification

Refer to the specifications of each communication device for the details of RS-485 device specifications.

◇ System configuration example

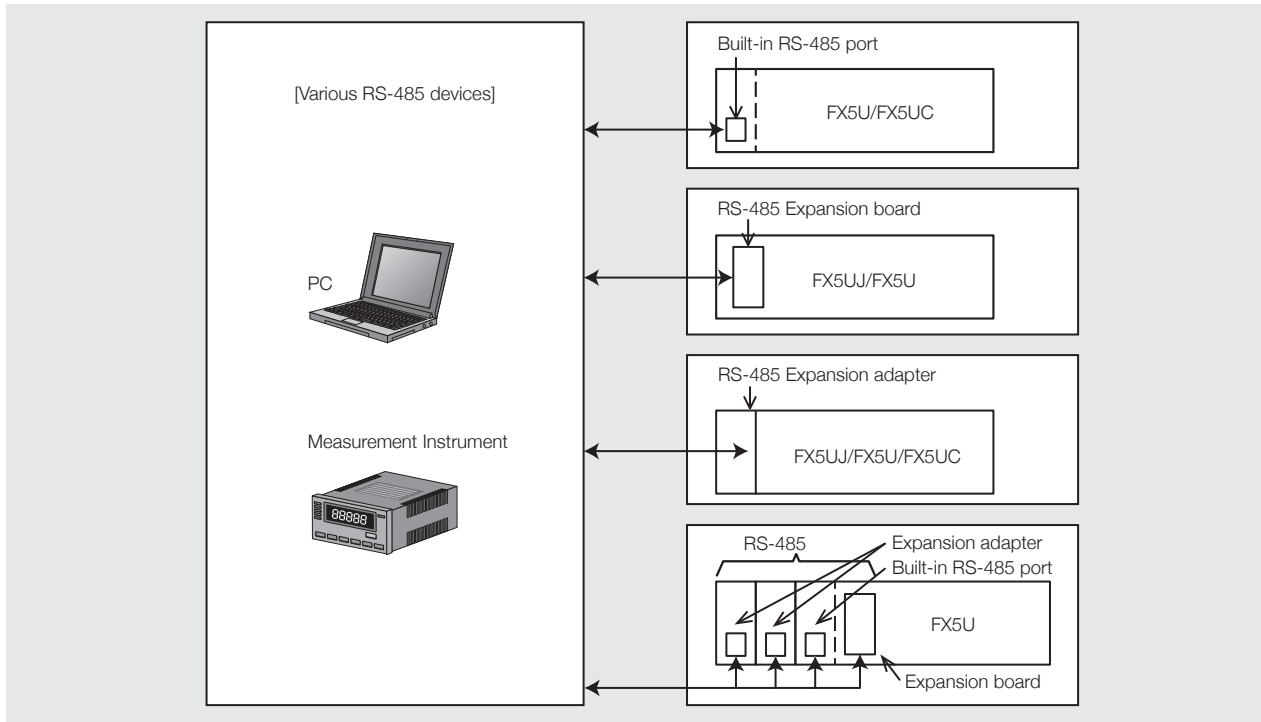



Connection to Peripheral Devices

Installing RS-422/RS-232C communication devices enables addition of connection ports with peripheral devices. PLC programming devices such as PC and HMI (GOT) can be connected to the added ports.

RS-232C communication

◇ RS-232C communication device

Model (No. of channels)	Communication method	Insulation	Maximum transmission distance	Compatible CPU module		
				FX5UJ	FX5U	FX5UC
FX5-232-BD (1 ch) 	Half-duplex bidirectional/ Full-duplex bidirectional	Non-isolation (between communication line and CPU)	15 m	○ (Max. 1 module)	○ (Max. 1 module)	×
FX5-232ADP (1 ch) 	Half-duplex bidirectional/ Full-duplex bidirectional	Photocoupler (between communication line and CPU)	15 m	○ (Max. 2 modules)	○ (Max. 2 modules)	○ (Max. 2 modules)

◇ Communication specification

Refer to the specifications of each communication device for the detailed specifications of RS-232C peripheral devices (programming protocol).

◇ Connection cable for RS-232C communication device and peripheral devices

The main connection cables are as follows:

Connection destination	Cable
DOS/PC (9-pin D-SUB)	FX-232CAB-1
HMI (GOT)	Use the specific cable or wire for RS-232C connection of each HMI.

◇ Concurrent use of peripheral device

Connect an engineering tool such as PC software to either one of peripheral devices to avoid programs from being changed by multiple peripheral devices.

RS-422 (GOT) communication

◇ RS-422 communication device

Model (No. of channels)	Communication method	Insulation	Maximum transmission distance	Compatible CPU module		
				FX5UJ	FX5U	FX5UC
FX5-422-BD-GOT (1 ch) 	Half-duplex bidirectional	Non-isolation (between communication line and CPU)	As per GOT specifications	○ (Max. 1 module)	○ (Max. 1 module)	×

◇ Communication specification

Refer to the manual of GOT.

◇ Communication cable



Use a dedicated cable for GOT.

Inverter Communication Function

Dedicated instructions for Mitsubishi Electric inverter protocol and communication control are built in FX5. Connecting an inverter enables simple control of inverter.

RS-485 communication

◇ RS-485 communication device

Model (No. of channels)	Communication method	Insulation	Maximum transmission distance	Control instruction	Compatible CPU module		
					FX5UJ	FX5U	FX5UC
FX5-485-BD (1 ch) 	Half-duplex bidirectional/ Full-duplex bidirectional*	Non-isolation (between communication line and CPU)	50 m	Inverter instruction	○ (Max. 1 module)	○ (Max. 1 module)	×
FX5-485ADP (1 ch) 	Half-duplex bidirectional/ Full-duplex bidirectional*	Photocoupler (between communication line and CPU)	1200 m	Inverter instruction	○ (Max. 2 modules)	○ (Max. 2 modules)	○ (Max. 2 modules)
Built-in RS-485 port (1 ch) 	Half-duplex bidirectional/ Full-duplex bidirectional*	Non-isolation (between communication line and CPU)	50 m	Inverter instruction	×	○	○

*: Half-duplex bidirection in case of connecting to inverter.

◇ System configuration example

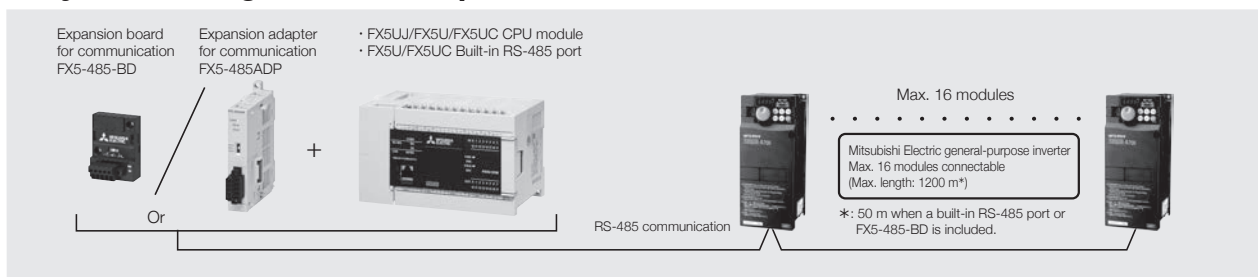

● Connectable Mitsubishi Electric general-purpose inverter



Inverter

[Connectable Models]
A800/A800 Plus/F800/E800/F700PJ/E700/E700EX (sensorless servo)/D700

OPC UA

By installing the OPC UA module (OPC UA server), OPC UA communication with the OPC UA client (an external application or device) can be performed. OPC UA communication is suitable for use in all networks including the Internet due to robust security.

FX5-OPC type OPC UA module

◆ Features



- 1) The FX5U/FX5UC CPU module can be connected to the OPC UA network.
- 2) The OPC UA server can be mounted in the equipment, and a robust system can be configured as an alternative to a PC-based OPC UA server.
- 3) The OPC UA security functions, such as certificate, encryption, and signing, can be used.
- 4) The dedicated setting tool (OPC UA Module Configuration Tool) enables you to set the IP address and security parameters, control the server certificate, and check/change the server status. After the initial setting, GX Works3 is not required. The functions can be operated only via the OPC UA Module Configuration Tool.

◆ Specifications

Items		Specifications	
OPC UA server	OPC UA version	1.03	
	Profile	Micro Embedded Device Server Profile For details, refer to the manual.	
	Service	For details, refer to the manual.	
	Address space	For details, refer to the manual.	
	User authentication	User name and password	
	Maximum number of parallel sessions	4	
	Maximum number of subscriptions per session	2	
	Maximum number of monitored items per subscription	500	
	Minimum sampling interval of a monitored item	100 ms	
	Maximum number of trusted certificates	10	
Time information	For details, refer to the manual.		
Network topology	Star topology		
Ethernet	Transmission specifications	Data transmission speed	100/10 Mbps
		Communication mode	Full-duplex or half-duplex*1
		Transmission method	Base band
		Interface	RJ45 connector
		Maximum segment length	100 m*2
	Number of cascade connections	100BASE-TX	2 levels maximum*3
		10BASE-T	4 levels maximum*3
Hub*1	Hubs with 100BASE-TX or 10BASE-T ports*4 can be used.		
Connection cable*5	100BASE-TX, 10BASE-T		
Number of ports	2		
Compatible CPU module	FX5U, FX5UC: Ver. 1.245 or later Connection with FX5UC CPU module requires connector conversion module (FX5-CNV-IFC) or extension power supply module (FX5-C1PS-5V).		
Applicable engineering tool	FX5U, FX5UC: GX Works3 Ver. 1.077F or later OPC UA Module Configuration Tool: Ver. 1.00A or later		
Number of occupied I/O points	8 points (Either input or output is available for counting.)		
Number of connectable modules	FX5U, FX5UC: Up to 1 module		
Power supply	24 V DC, 110 mA (internal power supply)		
External dimensions W × H × D (mm)	40 × 90 × 83		
MASS (Weight): kg	Approx. 0.2		

*1: IEEE802.3x flow control is not supported.
 *2: For maximum segment length (length between hubs), consult the manufacturer of the hub used.
 *3: This number applies when a repeater hub is used. When using a switching hub, check the number of cascaded stages with the manufacturer of the hub to be used.
 *4: The ports must comply with the IEEE802.3 100BASE-TX or IEEE802.3 10BASE-T standards.
 *5: A straight/cross cable can be used.

Engineering Tool

Various types of engineering software are prepared to enable easy programming for the Mitsubishi Electric PLC and realize comfortable operation.

MELSOFT iQ Works FA Integrated Engineering Software

- **iQ Works (English version)** **Model: SW2DND-IQWK-E (DVD-ROM)**

◇ Features

- By realization of a seamless integrated engineering environment, the total cost will be reduced.
- All the system labels can be checked on MELSOFT Navigator.
- Parameter settings for each project (GX Works3, GX Works2, MT Works2, and GT Works3) can be configured from MELSOFT Navigator.
This eliminates the need to launch various tools when configuring the parameter settings.
- System configuration can be managed graphically. Allows the user to manage the system configuration graphically, and the effort to search for an appropriate tool can be eliminated by linking the project.
- Double click the project from the system configuration figure and work space tree of MELSOFT Navigator to start the software for the device automatically.
- The data on whole system can be backed up in a batch by simple operation.

By realization of a seamless integrated engineering environment, the total cost will be reduced!

Sold as a set integrating various engineering software centered around MELSOFT Navigator, MELSOFT iQ Works eliminates the need to purchase software separately. The ability to share design information including system design and programming throughout the control system makes it possible to improve efficiency of system design and programming while reducing total costs.

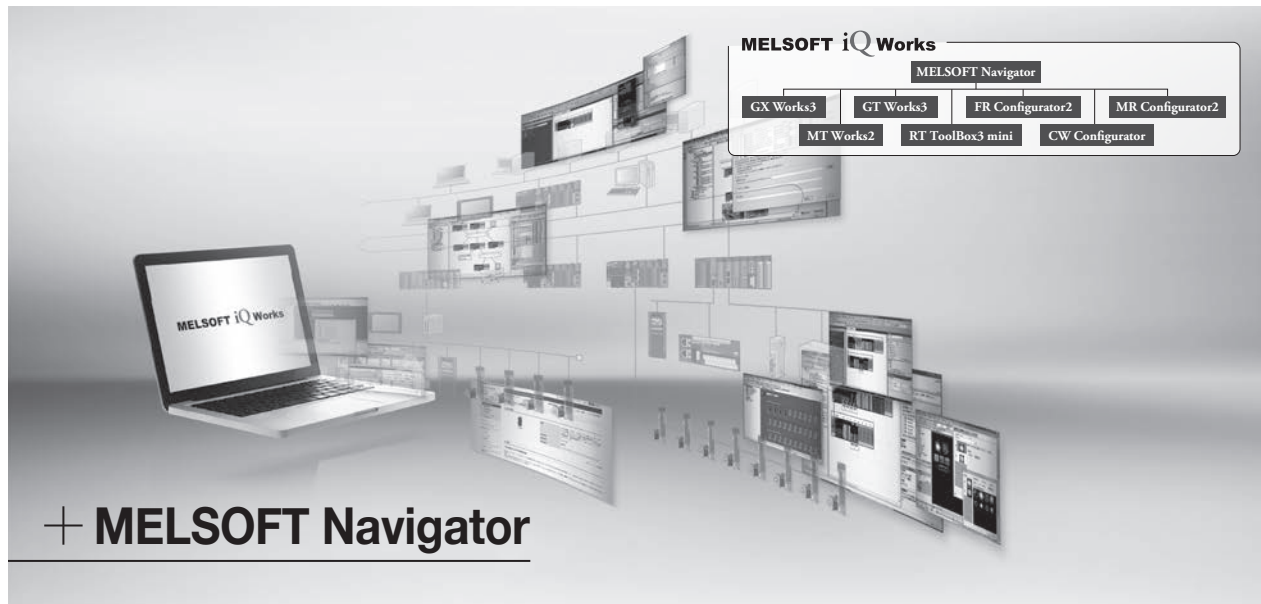

For details on MELSOFT iQ Works, refer to the following catalog:

"MELSOFT iQ Works catalog"
L(NA)08232ENG



MELSOFT GX Works3 PLC Engineering Software

● **GX Works3** **Model: SW1DND-GXW3-E (DVD-ROM)**

◇ Features

- Achieving an easy and intuitive programming by only making "selections" in a graphical environment with module configuration diagram and module label/module FB.
- Supporting various applications (parameter settings of simple motion module, creation of positioning data, parameter setting and servo adjustments of servo amplifier).
- Complying with the international standard IEC 61131-3 for engineering software and supporting the modularized and structured programming. Programming languages such as ladder, ST, FBD/LD, SFC* are available.
- Enabling transmitting/receiving of the data between an external device and the CPU module by matching the protocol of the external device. (Communication protocol support function)

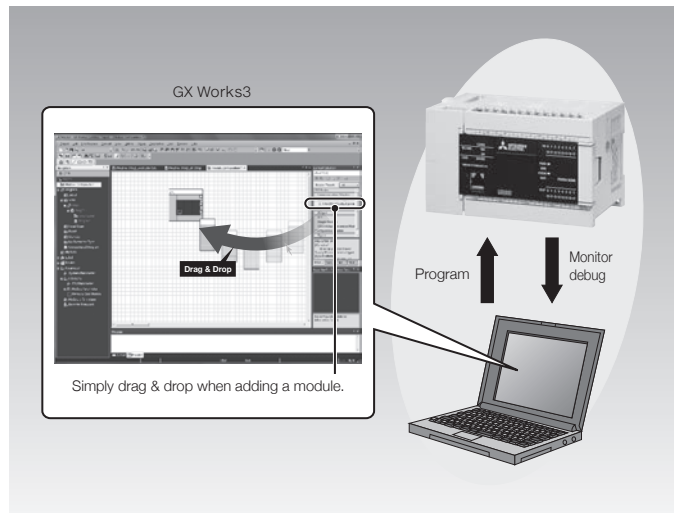

*: Supported in the FX5U/FX5UC CPU module firmware version 1.220 or later. In addition, GX Works3 version 1.070Y or later is required.

For details on MELSOFT GX Works3, refer to the following catalog available on request

"MELSOFT GX Works3 catalog"
L(NA)08334ENG



MELSOFT MX series Integrated Data Link Software

- **MX Component (Communication ActiveX Library)**
MX Component Ver. 4 Model: SW4DNC-ACT-E
MX Component Ver. 5 Model: SW5DND-ACT-E
- **MX Sheet (Microsoft® Excel® Communication Support Tool)**
MX Sheet Ver. 2 Model: SW2DNC-SHEET-E
MX Sheet Ver. 3 Model: SW3DND-SHEET-E
- **MX Works**
A set product of MX Component Ver. 4 and MX Sheet Ver. 2 Model: SW2DNC-SHEETSET-E
A set product of MX Component Ver. 5 and MX Sheet Ver. 3 Model: SW3DNC-SHEETSET-E

◇ Features

- A group of middleware remarkably improving development efficiency in the system configuration.
- Familiar Microsoft® Excel® settings on the screen enables easy data access of the on-site PLC without any program.
- Enabling the system to be configurable without considering a communication protocol.
- Enabling monitoring of on-site system only by setting parameters on the screen.
- Available in the 64-bit application. (MX Component Ver. 5)
- Available in the 64-bit version of Microsoft® Excel®. (MX Sheet Ver. 3)

Operating Environment

Engineering tool operating environment.
For details, refer to catalogs and manuals.

MELSOFT iQ Works and GX Works3 operating environment

Items		Contents		
PC Module	OS*1 English Version	Microsoft® Windows® 10 Home Microsoft® Windows® 10 Pro Microsoft® Windows® 10 Enterprise Microsoft® Windows® 10 Education Microsoft® Windows® 10 IoT Enterprise 2016 LTSB	Microsoft® Windows® 8.1 Microsoft® Windows® 8.1 Pro Microsoft® Windows® 8.1 Enterprise Microsoft® Windows® 8 Microsoft® Windows® 8 Pro Microsoft® Windows® 8 Enterprise	Microsoft® Windows® 7 Starter Microsoft® Windows® 7 Home Basic*3 Microsoft® Windows® 7 Home Premium Microsoft® Windows® 7 Professional Microsoft® Windows® 7 Ultimate Microsoft® Windows® 7 Enterprise
	CPU	Intel® Core™2 Duo 2 GHz or more recommended		
	Memory Requirements	1 GB or more recommended*2		
Hard Disc Free Space	[Installation] 26 GB or more*4 free disk space, [Operation] 512 MB or more free virtual memory			
Disc Drive	DVD-ROM supported disc drive			
Display	Resolution 1024 x 768 pixels or more			
Connection to PLC	Optional connection cable and interface are necessary. [PC Communication Port] Connectable from Ethernet port, USB (Mini-B) port, or RS-232C port. FX5UJ PLC : Directly connectable by Ethernet and USB, or connectable via an RS-232C communication expansion adapter or an RS-232C communication expansion board. FX5U PLC : Directly connectable by Ethernet, or connectable by RS-232C communication expansion adapter or RS-232C communication expansion board. FX5UC PLC : Directly connectable by Ethernet or connectable by RS-232C communication expansion adapter. Refer to the "PC and PLC Connection Method and Required Equipment" for the details of connection method and required cable types.			
Compatible CPU module	FX5UJ, FX5U, FX5UC (Refer to the specific catalog or manual for details on FX Series, L Series, Q Series, and iQ-R Series modules.)			

- *1: 32-bit version of Microsoft® Windows® 10 IoT Enterprise 2016 LTSB is not supported.
- *2: 2 GB or more recommended for 64-bit version
- *3: iQ Works is not supported.
- *4: 17 GB or more for installing only GX Works3

PC and PLC Connection Method and Required Equipment

◇ In case of connection between Ethernet port on the PC side

Connecting to the Ethernet port

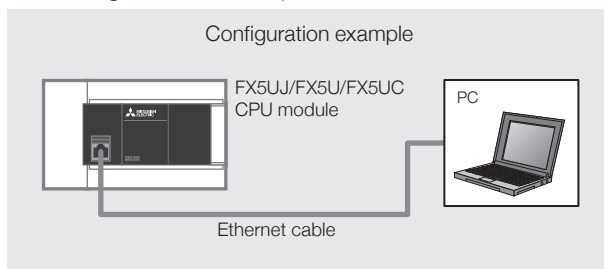

◇ In case of connection between USB port on the PC side

Connecting to the USB (Mini-B) port

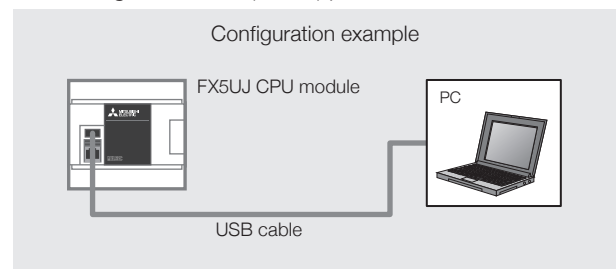

◇ In case of connection between RS-232C port on the PC side

(1) Connection with the RS-232C port attached to PLC (using FX5-232ADP)

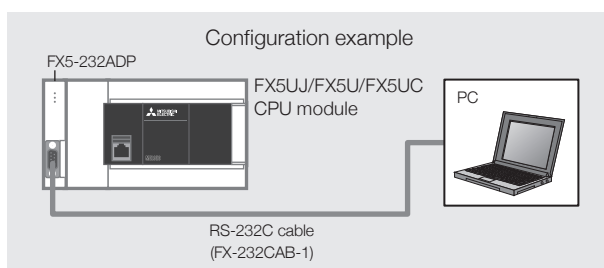

(2) Connection with the RS-232C port attached to PLC (using FX5-232-BD)

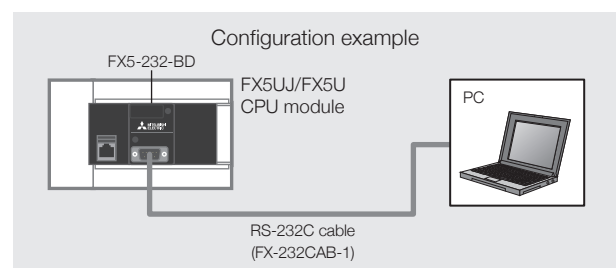

Compatible Versions of Software

The followings are compatible versions of each software.

New versions may be required due to addition of functions and products. Please refer to the manuals for more details.

Category	Type	Compatible version			Precautions
		FX5UJ	FX5U	FX5UC	
Software for PLC	iQ Works	Ver. 2.62Q or later	Ver. 2.07H or later	Ver. 2.07H or later	Use the latest version when new functions are added.
	GX Works3	Ver. 1.060N or later	Ver. 1.007H or later	Ver. 1.007H or later	
Software for GOT (GOT1000 series, GOT2000 series)	GT Works3	Ver. 1.225K or later	Ver. 1.126G or later	Ver. 1.126G or later	Compatible to the device scope. Refer to the GOT manual for other compatible items.

Option/Related Products

We are pleased to offer you a wide variety of our products including SD memory cards, batteries, connection cables for PLC as well as interfaces for signal exchange.

SD Memory Card



Model/Appearance	Contents		
NZ1MEM-2GBSD NZ1MEM-4GBSD NZ1MEM-8GBSD NZ1MEM-16GBSD 	NZ1MEM-2GBSD	Type	SD memory card
		Capacity	2 GB
	NZ1MEM-4GBSD	Type	SDHC memory card
		Capacity	4 GB
	NZ1MEM-8GBSD	Type	SDHC memory card
		Capacity	8 GB
	NZ1MEM-16GBSD	Type	SDHC memory card
		Capacity	16 GB





Battery

Model/Appearance	Contents
FX3U-32BL 	The battery can be used to retain (latch) the status of the device memory or clock data before a power failure. At the time of delivery from the factory, the battery is not built in the CPU module. Please make arrangements if required. Setting of parameter is required for power failure retention.

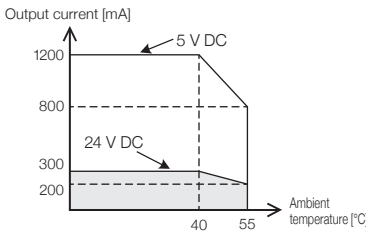
Extension Device

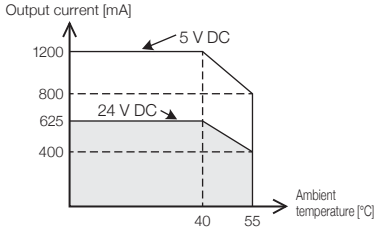
The extension cable for connecting to the right side of the front-stage device has been attached to the extension module (extension cable type).

Model/Characteristics	Items	Specifications	
◆ Bus Conversion Module			
FX5-CNV-BUS (FX5 (extension cable type) – FX3 extension)  Conversion module for connecting FX3 extension module to FX5U and FX5UC CPU modules.	Compatible CPU module	FX5U, FX5UC Connection with FX5UC CPU module requires connector conversion module (FX5-CNV-IFC) or extension power supply module (FX5-C1PS-5V).	
	No. of occupied I/O points	8 points (Either input or output is available for counting.)	
	No. of connectable modules	Max. 1 module	
	Current consumption (internal supply)	5 V DC 150 mA	
	External dimensions W × H × D (mm)	16 × 90 × 83	
	MASS (Weight): kg	Approx. 0.1	
	FX5-CNV-BUSC (FX5 (extension connector type) – FX3 extension)  Conversion module for connecting FX3 extension modules to FX5U and FX5UC CPU modules.	Compatible CPU module	FX5U, FX5UC Connection with FX5U CPU module requires connector conversion module (FX5-CNV-IF).
No. of occupied I/O points		8 points (Either input or output is available for counting.)	
No. of connectable modules		Max. 1 module	
Current consumption (internal supply)		5 V DC 150 mA	
External dimensions W × H × D (mm)		16 × 90 × 83	
MASS (Weight): kg		Approx. 0.1	
◆ Extension Power Supply Module			
FX5-1PSU-5V  Module for extending power supply if FX5UJ, FX5U (AC power supply type) CPU module's internal power supply is insufficient. Extension cable is enclosed. Derating diagram 	Rated power supply voltage	100 to 240 V AC	
	Voltage variation range	-15%, +10%	
	Rated frequency	50/60 Hz	
	Allowable instantaneous power failure time	Operation can be continued upon occurrence of instantaneous power failure for 10 ms or less.	
	Power fuse	250 V 3.15 A time lag fuse	
	Rush current	Max. 25 A 5 ms or less/100 V DC Max. 50 A 5 ms or less/200 V DC	
	Power consumption	Max. 20 W	
	Current output (back-stage supply)	24 V DC	300 mA (Maximum output current depends on the ambient temperature.)
		5 V DC	1200 mA (Maximum output current depends on the ambient temperature.)
	Compatible CPU module	FX5UJ, FX5U (AC power supply type)	
	No. of occupied I/O points	0 points (no occupied points)	
	No. of connectable modules	Max. 2 modules	
	External dimensions W × H × D (mm)	50 × 90 × 83	
	MASS (Weight): kg	Approx. 0.3	

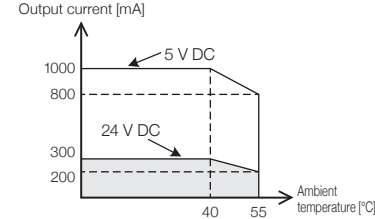

Model/Characteristics	Items	Specifications	
<p>FX5-C1PS-5V</p>  <p>This is an extension power supply which is added when the built-in power supply of the DC power supply type FX5U/FX5UC CPU module is insufficient. Only one of the connector connection and cable connection can be used for the next-stage extension connector of the extension power supply module.</p> <p>Derating diagram</p> 	Power supply voltage	24 V DC	
	Voltage variation range	+20%, -15%	
	Allowable instantaneous power failure time	Operation can be continued upon occurrence of instantaneous power failure for 5 ms or less.	
	Power fuse	125 V 3.15 A time lag fuse	
	Rush current	Max. 35 A 0.5 ms or less/24 V DC	
	Power consumption	Max. 30 W	
	Current output (back-stage supply)	24 V DC	625 mA (Maximum output current depends on the ambient temperature.)
		5 V DC	1200 mA (Maximum output current depends on the ambient temperature.)
	Compatible CPU module	FX5U (DC power supply type), FX5UC	
	No. of occupied I/O points	0 points (no occupied points)	
	No. of connectable modules	Max. 2 modules	
	External dimensions W × H × D (mm)	20.1 × 90 × 74	
	MASS (Weight): kg	Approx. 0.1	
◆ Connector Conversion Module			
<p>FX5-CNV-IF (FX5 (extension cable type) – FX5 (extension connector type))</p>  <p>Converts the connector for connecting an extension connector type for FX5.</p>	Compatible CPU module	FX5UJ, FX5U	
	No. of occupied input/output points	0 points (No occupied I/O)	
	No. of connectable modules	Max. 1 module	
	Current consumption (internal supply)	0 mA (no power consumed)	
	External dimensions W × H × D (mm)	14.6 × 90 × 74	
	MASS (Weight): kg	Approx. 0.06	
<p>FX5-CNV-IFC (FX5 (extension connector type) – FX5 (extension cable type))</p>  <p>Converts the connector for connecting an extension cable type for FX5.</p>	Compatible CPU module	FX5UC	
	No. of occupied I/O points	0 points (No occupied I/O)	
	No. of connectable modules	Max. 1 module	
	Current consumption (internal supply)	0 mA (no power consumed)	
	External dimensions W × H × D (mm)	14.6 × 90 × 74	
	MASS (Weight): kg	Approx. 0.06	
◆ Extension Power Supply Module (for FX3 Extension Module)			
<p>FX3U-1PSU-5V</p>  <p>For extension of power supply when power supply for FX3 extension module is insufficient.</p> <p>Derating diagram</p> 	Power supply voltage	100 to 240 V AC	
	Allowable power supply voltage range	85 to 264 V AC	
	Rated frequency	50/60 Hz	
	Allowable instantaneous power failure time	Conditions vary depending on power sources as follows: <ul style="list-style-type: none"> 100 V AC power supply: Operation can be continued upon occurrence of instantaneous power failure for 10 ms or less. 200 V AC power supply: Operation can be continued upon occurrence of instantaneous power failure for 100 ms or less. 	
	Rush current	Max. 30 A 5 ms or less/100 V AC Max. 65 A 5 ms or less/200 V AC	
	Power consumption	Max. 20 W	
	Current output (back-stage supply)	24 V DC	0.3 A (Derate the maximum output current at an ambient temperature of 40°C or above.)
		5 V DC	1 A (Derate the maximum output current at an ambient temperature of 40°C or above.)
	Compatible CPU module	FX5U (AC power supply type)	
	No. of occupied I/O points	0 points (no occupied points)	
	No. of connectable modules	Max. 2 modules	
	External dimensions W × H × D (mm)	55 × 90 × 87	
	MASS (Weight): kg	Approx. 0.3	

Extension Module Options (Extended Extension Cables/Connector Conversion Adapters)

FX5 extension modules (extension cable type) are equipped with the extension cable for connection to the right side of the front-stage device.

If intending extension of the connection distance or two-row placement of PLCs, an optional "Extended extension cable" is required. Only a single extended extension cable can be used per system.

◇ Extended extension cable

Model	Specifications
FX5-30EC (30 cm) FX5-65EC (65 cm) 	◇ Extended extension cable Extension cable for the FX5 extension module. Only a single cable can be used per system. Depending on the CPU module to be used or the device to be connected with, the following connection conversion adapter (FX5-CNV-BC) is required. [Connector conversion adapter required] When the connection destination is an input/output module (extension cable type), high-speed pulse I/O module, or FX5 intelligent function module
FX5-CNV-BC 	● Connector conversion adapter This connects between an extension cable and an extension cable type module when an extended extension cable is used.

◇ Main connection methods

1) Connections with the Powered I/O module and FX5 extension power supply module (extension cable type)

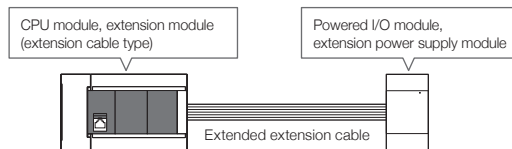

2) Connections with the input/output module (extension cable type) and FX5 intelligent function module

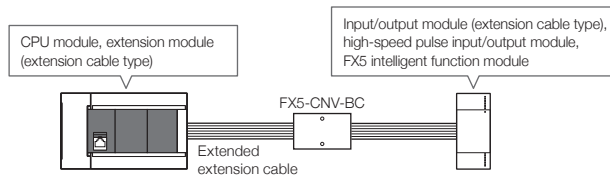

3) Connections with the input/output module (extension cable type) and FX5 intelligent function module

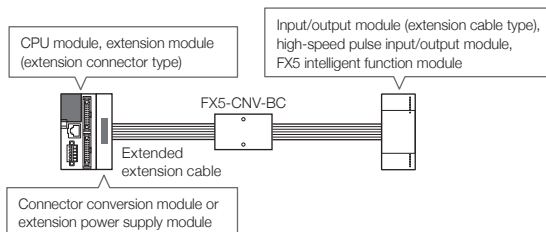

Terminal Block

This allows conversion of the connector of the FX5UC CPU module or the I/O module (extension connector type) to the screw terminal block, resulting in the reduced number of man-hours for I/O wiring. Using an internal type of I/O element enables driving of a heavy load by a relay or a transistor.

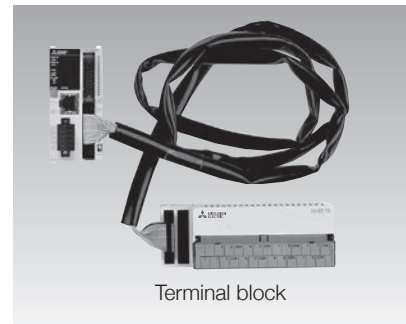

◇ **List of Terminal Blocks** (Refer to the next page for the details of connection cables and optional connectors.)

Model	No. of input points	No. of output points	Function
FX-16E-TB	Input 16 points or output 16 points		Directly connected to the I/O terminal of PLC.
FX-32E-TB	Input 32 points or output 32 points (Division possible: input 16 points and output 16 points)		Using this module instead of the PLC terminals or relaying a wiring of I/O device located remotely from PLC enables reducing of the I/O wiring man-hours.
FX-16E-TB/UL	Input 16 points or output 16 points		
FX-32E-TB/UL	Input 32 points or output 32 points (Division possible: input 16 points and output 16 points)		
FX-16EYR-TB	—	16	Relay Output Type
FX-16EYS-TB	—	16	Triac Output Type
FX-16EYT-TB	—	16	Transistor Output Type (Sink output)
FX-16EYR-ES-TB/UL	—	16	Relay Output Type
FX-16EYS-ES-TB/UL	—	16	Triac Output Type
FX-16EYT-ESS-TB/UL	—	16	Transistor Output Type (Source output)

◇ **Specifications**

1. PLC Direct Connection (FX-16E-TB, FX-32E-TB)

Since it is for direct connection of PLC I/O terminal, no electrical components are built in.

Electrical specifications are equivalent to that of the connected CPU module or connector type I/O module. A drawing on the right shows the internal connection of FX-16E-TB. In the case of FX-32E-TB, it is connected to CN2 in the same manner.

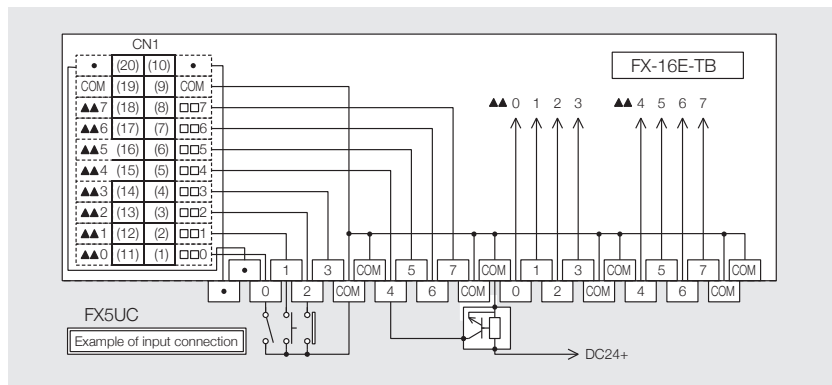



2. Output (FX-16EY□-TB)



Model	Relay output FX-16EYR-TB	Triac output FX-16EYS-TB	Transistor output (Sink output) FX-16EYT-TB
I/O circuit configuration			
Load voltage	250 V AC 30 V DC or less	85 V to 242 V AC	5 V to 30 V DC
Circuit insulation	Mechanical insulation	Photocopier	Photocopier
Operation display	An LED is turned on when applying an electrical current to a relay coil	An LED is turned on when applying an electrical current to a photthyristor	An LED is turned on when applying an electrical current to a photocopier
Max. load	Resistance load	0.3 A/1 point 0.8 A/4 points	0.5 A/1 point 0.8 A/4 points
	Inductive load	80 VA	15 VA/100 V AC, 36VA/240 V AC
Open circuit leakage current	—	1 mA/A100 V AC, 2 mA/200 V AC	0.1 mA/30 V DC
Min. load	5 V DC, 2 mA (reference value)	0.4 VA/100 V AC, 1.6 VA/200 V AC	—
Response time	OFF → ON	Approx. 10 ms	2 ms or less
	ON → OFF	Approx. 10 ms	12 ms or less
Input signal current	5 mA/24 V DC for each point (current consumption)	7 mA/24 V DC for each point (current consumption)	7 mA/24 V DC for each point (current consumption)



Option/Related Products

I/O Cable

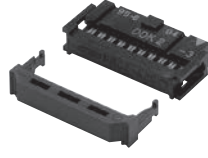
Model/Appearance	Contents
FX-16E-500CAB-S (5 m) 	<ul style="list-style-type: none"> ● General-purpose I/O cable <p>A 20-pin connector attached to one end of bulk wire</p>
FX-16E-150CAB (1.5 m) FX-16E-300CAB (3 m) FX-16E-500CAB (5 m) 	<ul style="list-style-type: none"> ● I/O cable for Terminal block <p>A 20-pin connector attached to both ends of a flat cable (with tube)</p>
FX-16E-150CAB-R (1.5 m) FX-16E-300CAB-R (3 m) FX-16E-500CAB-R (5 m) 	<ul style="list-style-type: none"> ● I/O cable for Terminal block <p>A 20-pin connector attached to both ends of round multi core cable</p>



I/O Connector

Model/Appearance	Contents
FX2C-I/O-CON 	<ul style="list-style-type: none"> ● Flat cable connector <ul style="list-style-type: none"> ● AWG28 (0.1 mm²): A set of 10 pcs ● Crimp connector: FRC2-A020-3OS 1.27-pitch 20 cores ● Crimp tool: Separately arrange the tool manufactured by DDK Ltd. 357J-4674D Main Module 357J-4664N Attachment
(1) FX2C-I/O-CON-S (2) FX2C-I/O-CON-SA 	<p>(1) Connector for single wires AWG22 (0.3 mm²): 5 sets</p> <ul style="list-style-type: none"> ● Housing: HU-200S2-001 ● Crimp contact: HU-411S ● Crimp tool: A product manufactured by DDK Ltd. is separately required. 357J-5538 <p>(2) Connector for single wires AWG20 (0.5 mm²): 5 sets</p> <ul style="list-style-type: none"> ● Housing: HU-200S2-001 ● Crimp contact: HU-411SA ● Crimp tool: A product manufactured by DDK Ltd. is separately required. 357J-13963

Model/Appearance	Contents
<ul style="list-style-type: none"> ◆ Connector for self-manufactured I/O cable: 40-pin type (electric wire or crimp tool is not enclosed.) (1) A6CON1* (2) A6CON2 (3) A6CON4* 	<p>(1) Soldered type connector (straight protrusion) Twist wire 0.088 to 0.3 mm² (AWG28 to 22)</p> <p>(2) Crimped type connector (straight protrusion) Twist wire 0.088 to 0.24 mm² (AWG28 to 24)</p> <p>(3) Soldered type connector (both straight/inclined protrusion type) Twist wire 0.088 to 0.3 mm² (AWG28 to 22)</p>
For FX5-20PG-P, FX5-20PG-D (1) FX-I/O-CON2-S (2) FX-I/O-CON2-SA 	<p>(1) Connector for single wires AWG22 (0.3 mm²): 2 sets</p> <ul style="list-style-type: none"> ● Housing: HU-400S2-001 ● Crimp contact: HU-411S ● Crimp tool: A product manufactured by DDK Ltd. is separately required. 357J-5538 <p>(2) Connector for single wires AWG20 (0.5 mm²): 2 sets</p> <ul style="list-style-type: none"> ● Housing: HU-400S2-001 ● Crimp contact: HU-411SA ● Crimp tool: A product manufactured by DDK Ltd. is separately required. 357J-13963

*: Select wires with a sheath outside diameter of 1.3 mm or less when using 40 wires. Select wires suitable to the current value used.

Power Cable

Model/Appearance	Contents
FX2NC-100MPCB (1 m) 	<ul style="list-style-type: none"> ●CPU module power cable <p>Cable for providing 24 V DC power supply to the FX5UC CPU module. Comes with the FX5UC CPU modules and intelligent function modules*.</p>
FX2NC-100BPCB (1 m) 	<ul style="list-style-type: none"> ●Power cable <p>Cable for supplying 24 V DC input power supply to an extension connector type input module or input/output module. Offered as an accessory of FX5UC-□MT/D. It is necessary to purchase this cable separately when using an extension connector type input module or input/output module in the FX5U system.</p>
FX2NC-10BPCB1 (0.1 m) 	<ul style="list-style-type: none"> ●Power supply transition cable <p>Cable for crossover wiring of 24 V DC input power supply to two or more extension connector type input modules or input/output modules. Offered as an accessory of FX5-C□EX/D and FX5-C32ET/D.</p>







*: There are some exception models. For details, refer to the manual.

Communication cable

Model/Appearance	Contents
FX-232CAB-1 (3 m) 	<ul style="list-style-type: none"> ●RS-232C connection cable for personal computer <p>Cable for connecting between FX5 PLC and personal computer through RS-232C communication D-sub 9-pin (female) ⇔ D-sub 9-pin (female) (for DOS/V, etc.)</p>
MR-J3USBCL3M (3 m)	<ul style="list-style-type: none"> ●Personal computer communication cable (USB cable) <p>Cable for connecting between FX5UJ CPU module and personal computer through USB communication CPU module (built-in connector for USB communication) ⇔ personal computer</p>
GT09-C30USB-5P (3 m)	<ul style="list-style-type: none"> ●Data transfer cable <p>Cable for connecting between FX5UJ CPU module and personal computer through USB communication CPU module (built-in connector for USB communication) ⇔ personal computer Made by Mitsubishi Electric System & Service Co., Ltd.</p>

Option/Related Products

Related products Reduced wiring and man-hour saving machines for programmable controllers (FA goods) [manufactured by Mitsubishi Electric Engineering Co., Ltd.]

Model/external appearance	Description
FA-CBLQ75PM2J3 (2 m) FA-CBLQ75M2J3 (-P) (2 m) 	<ul style="list-style-type: none"> ●Connection cable <p>Mitsubishi Electric MR-J3-A/J4-A series</p> <ul style="list-style-type: none"> ●Connectable models <p>FA-CBLQ75PM2J3: FX5-20PG-P FA-CBLQ75M2J3 (-P): FX5-20PG-D</p>
FA-CBLQ75G2 (-P) (2 m) 	<ul style="list-style-type: none"> ●Connection cable <p>General-purpose stepping motor, discrete wire cable for servo amplifier</p> <ul style="list-style-type: none"> ●Connectable models <p>FX5-20PG-P, FX5-20PG-D</p>
FA-LTBQ75DP 	<ul style="list-style-type: none"> ●Positioning signal conversion module <p>Converts the external device connection signal of the positioning module to the terminal block and converts the signal between the servo amplifiers to the connect.</p>
FA-CBL05Q7 (0.5 m) FA-CBL10Q7 (1 m) 	<ul style="list-style-type: none"> ●Connection cable <p>Positioning signal conversion module ⇔ Connection cable between positioning signal conversion modules</p>
FA-CBLQ7PM1J3 (1 m) FA-CBLQ7DM1J3 (1 m) 	<ul style="list-style-type: none"> ●Connection cable <p>Positioning signal conversion module ⇔ Connection cable between servo amplifiers (for Mitsubishi Electric MR-J3-A/J4-A series)</p>
FA-CBLQ7DG1 (1 m) 	<ul style="list-style-type: none"> ●Connection cable <p>Positioning signal conversion module ⇔ Connection cable between servo amplifiers (for general-purpose stepping motor and servo amplifier)</p>

Technical information, technical support

Function Block library

The FB library is a set of program parts for PLC.

For Function Block library, please consult your local Mitsubishi representative.

For the specifications and functions of the FB, refer to the attached reference manual and the reference manual for each module.

◇ Function Block list

Library name	Overview	Compatible CPU module		
		FX5UJ	FX5U	FX5UC
FX5 CPU module Function Block	Module FB (for GX Works3) for using the input/output, positioning, serial communication, high-speed counter, and temperature control of the CPU module.	○	○	○
Multiple input module Function Block	The module Function Blocks (for GX Works3) to use the multiple input module (FX5-8AD).	○	○	○
Analog input module Function Block	The module Function Blocks (for GX Works3) to use the analog input module (FX5-4AD).	○	○	○
Analog output module Function Block	The module Function Blocks (for GX Works3) to use the analog output module (FX5-4DA).	○	○	○
FX5 Ethernet-equipped module Function Block	The module Function Blocks (for GX Works3) to use the FX5 Ethernet-equipped module.	○	○	○
FX5-ENET Ethernet-equipped module Function Block	The module Function Blocks (for GX Works3) to use the FX5 Ethernet module.	○	○	○
FX5 EtherNet/IP-equipped module Function Block	The module Function Blocks (for GX Works3) to use the FX5 EtherNet/IP module.	○	○	○
CC-Link IE TSN module Function Block	The module Function Blocks (for GX Works3) to use the CC-Link IE TSN module.	—	○	○
CC-Link IE Field Network module Function Block	The module Function Blocks (for GX Works3) to use the CC-Link IE Field Network module.	○	○	○
Positioning module Function Block	The module Function Blocks (for GX Works3) to use the positioning module.	○	○	○
Simple motion module Function Block	The module Function Blocks (for GX Works3) to use the simple motion module.	○	○	○
FB for replacement with FX2N-20GM	FB library for using the functions of FX2N-20GM using the positioning function module (FX5-20PG-□).	○	○	○
Statistical analysis Function Block	FB library for statistical analysis using the CPU module.	○	○	○
Cam output control Function Block	FB library for using the cam output control functions using the CPU module.	—	○	○
FB for inverter compatible with CC-Link IE Field Network Basic	FB library for using the inverter compatible with CC-Link IE Field Network Basic through the built-in Ethernet in the CPU module.	○	○	○
e-F@ctory Starter Package* Overall equipment effectiveness monitor	Sample program for displaying overall equipment effectiveness, availability, performance rate, finished good ratio, ratio of non-operating time to operating time of equipment, and production information, and for collectively monitoring the equipment operation condition.	—	○	○
e-F@ctory Starter Package* Cylinder & cycle time measurement monitor	Sample program for measuring and monitoring the cylinder operating time and equipment cycle time.	—	○	○
Predefined protocol support for positioning Function Block (IAI)	FB library for connecting and using the CPU module and IAI's Robo Cylinder via MODBUS RTU communication.	—	○	○
Predefined protocol support for positioning Function Block (SMC)	FB library for connecting and using the CPU module and SMC's Robo Cylinder via MODBUS RTU communication.	—	○	○
Predefined protocol support for positioning Function Block (ORIENTAL MOTOR)	FB library for connecting and using the CPU module and Oriental Motor's Robo Cylinder via MODBUS RTU communication.	—	○	○

*: Please consult your local Mitsubishi representative.

For the latest information on each FB and its compatibility, please consult your local Mitsubishi representative.

memo

Overseas Service System

Mitsubishi Electric's Micro PLC Series is a worldwide programmable controller that is used in more than 50 countries all over the world.

For local after-sales services in the overseas countries, "Mitsubishi Electric Global FA Centers" timely provide the best possible products, high technology and reliability services to our customers.

Global FA Center

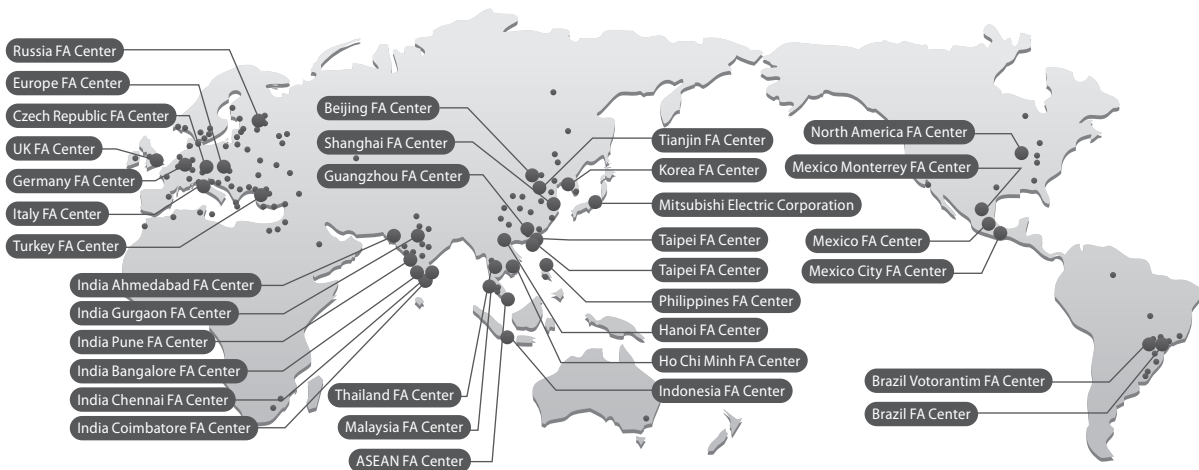

◆ FA Global Service Network "Place contact our FA Center first."

For consultation and questions, please contact our FA centers in each country. With our FA centers in each region of the world as key stations, we provide various services to customers while working closely with local sales offices, branches and agencies.

◆ Detailed information on overseas service

"FA global service" (KK001-EN)
Service contents and contact information of our FA centers are detailed.
For more information on overseas support, please request this document.

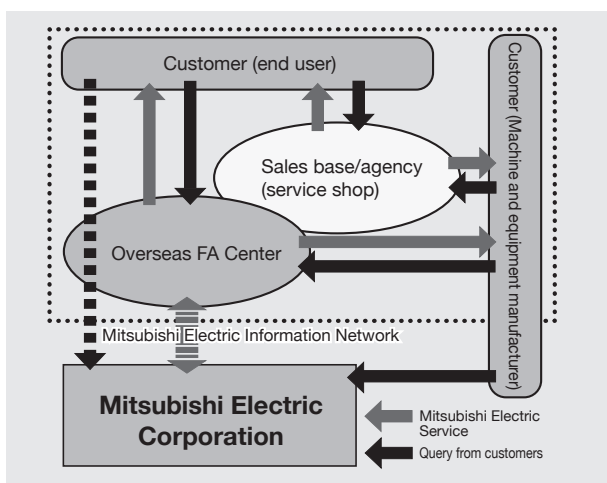

Certifications

MELSEC iQ-F Series conforms to European Standards (EN) and North American Standards (UL/cUL). Using MELSEC iQ-F Series can reduce the workload to make machines/equipment conform to EN and UL/cUL standards.

◇ Compatible with international standards

The MELSEC iQ-F series conforms to CE marking (Europe) and UL/cUL standard (USA, Canada) and therefore can be used for overseas facilities.



◇ EN standards: Compliance with EC Directives/CE marking

EC directives are issued by the European Council of Ministers for the purpose of unifying European national regulations and smoothing distribution of safe guaranteed products. Approximately 20 types of major EC directives concerning product safety have been issued.

Attachment of a CE mark (CE marking) is mandatory on specific products before they may be distributed in the EU. The EMC Directive (Electromagnetic Compatibility Directive), LVD Directive (Low Voltage Directive), and MD Directive (Machinery Directive) are applied to the programmable controller, which is labeled as an electrical part of a machine product under the EC Directives.

1) EMC Directive

The EMC Directive is a directive that requires products to have “Capacity to prevent output of obstructive noise that adversely affects external devices: Emission damage” and “Capacity to not malfunction due to obstructive noise from external source: Immunity”.

2) LVD Directive (Low Voltage Directive)

The LVD Directive is enforced to distribute safe products that will not harm or damage people, objects or assets, etc. With the programmable controller, this means a product that does not pose a risk of electric shock, fire or injury, etc.

3) MD Directive (Machinery Directive)

The MD Directive is for machines and machine parts that may cause injury to the operator due to mechanical moving parts. Safety control equipment must be certified by a recognized body.



◇ **UL/cUL Standards**

UL is the United State’s main private safety testing and certification agency for ensuring public safety.

UL sets the safety standards for a variety of fields. Strict reviews and testing are performed following the standards set forth by UL. Only products which pass these tests are allowed to carry the UL Mark.

As opposed to the EN Standards, the UL Standards do not have a legally binding effect. However, they are broadly used as the U.S. safety standards, and are an essential condition for selling products into the U.S.

UL is recognized as a certifying and testing agency by the Canadian Standards Association (CSA). Products evaluated and certified by UL in accordance with Canadian standards are permitted to carry the cUL Mark.

[Precautions on the use in UL/cUL Class I, Division 2 environment]

Products* marking Cl. I, DIV.2 indicating that they can be used in the Class I, Division 2 (filling in a flammable environment in case of abnormalities) on the rating plate can be used in Class I, Division 2 Group A, B, C, and D only. They can be used regardless of the display as long as they do not reach the danger.

Note that when using a product in Class I, Division 2 environment, the following measures need to be taken for the risk of explosion.

- As this product is an open-type device, attach it to the control board suitable for the installation environment and, for opening, to the control board which requires a tool or key.
- Substitution of products other than Class I, Division 2 compatible may result in degradation of Class I, Division 2 compliance. Therefore, do not substitute products other than compatible products.
- Do not disconnect/connect the device or disconnect the external connection terminal except when the power is turned off or where there is no danger.
- Do not open the battery except where it is out of reach of danger.



*: UL explosion-proof standard compliant products are as follows. (Manufactured in October 2017 and after)

- FX5U CPU module
- FX5UC-32MT/D, FX5UC-32MT/DSS, FX5UC-64MT/D, FX5UC-64MT/DSS, FX5UC-96MT/D, and FX5UC-96MT/DSS
- FX5 extension module
- FX5-C16EX/D, FX5-C16EX/DS, FX5-C16EYT/D, FX5-C16EYT/DSS, FX5-C32EX/D, FX5-C32EX/DS, FX5-C32EYT/D, FX5-C32EYT/DSS, FX5-C32ET/D, FX5-C32ET/DSS, FX5-232ADP, FX5-485ADP, FX5-C1PS-5V, FX5-CNV-BUSC, FX5-4AD-ADP, and FX5-4DA-ADP

◇ **Ship standards**

The MELSEC iQ-F series complies with the shipping standards of each country.

It can be used for ship-related machinery and equipment.

Standard abbreviation	Standard name	Target country
DNV	DNV AS	Norway/Germany
RINA	REGISTRO ITALIANO NAVALE	Italy
ABS	American Bureau of Shipping	U.S.A.
LR	Lloyd’s Register of Shipping	U.K.
BV	Bureau Veritas	France
NK	Nippon Kaiji Kyokai	Japan
KR	Korea Ship Association	Korea

◇ **Korean Certification Mark (KC Mark)**

- The KC mark, which is a safety certification mark required to be affixed to the specified products distributed in Korea (products required to be legally certificated for safety, quality, environment, etc.), indicates compliance with various requirements.
- KC mark is indicated on FA products, which conform to the Radio Act. Note that other standards are not applicable.

Performance Specifications



FX5UJ

◇ FX5UJ CPU module performance specifications

Items		Specifications
Control system		Stored-program repetitive operation
Input/output control system		Refresh system (Direct access input/output allowed by specification of direct access input/output [DX, DY])
Programming specifications	Programming language	Ladder diagram (LD), structured text (ST), function block diagram/ladder diagram (FBD/LD)
	Programming expansion function	Function block (FB), function (FUN), label programming (local/global)
	Constant scan	0.5 to 2000 ms (can be set in 0.1 ms increments)
	Fixed cycle interrupt	1 to 60000 ms (can be set in 1 ms increments)
	Timer performance specifications	100 ms, 10 ms, 1 ms
Operation specifications	No. of program executions	32
	No. of FB files	16 (Up to 15 for user)
Execution type	Execution type	Standby type, initial execution type, scan execution type, event execution type
	Interrupt type	Internal timer interrupt, input interruption, high-speed comparison match interrupt, interrupt by modules*1
Command processing time	LD X0	34 ns
	MOV D0 D1	34 ns
Memory capacity	Program capacity	48 k steps (96 kbytes, flash memory)
	SD memory card	Memory card capacity (SD/SDHC memory card: Max. 16 Gbytes)
	Device/label memory	120 kbytes
	Data memory/standard ROM	5 Mbytes
Flash memory (Flash ROM) write count		Maximum 20000 times
File storage capacity	Device/label memory	1
	Data memory	P: 32, FB: 16
	P: No. of program files FB: No. of FB files	
	SD memory card	NZ1MEM-2GBSD: 511*2 NZ1MEM-4GBSD, NZ1MEM-8GBSD, NZ1MEM-16GBSD: 65534*2
Clock function	Display data	Year, month, day, hour, minute, second, day of week (leap year automatic detection)
	Precision	Differences per month ± 45 sec./25°C (TYP)
No. of input/output points	(1) No. of input/output points	256 points or less
	(2) No. of remote I/O points	256 points or less
	Total No. of points of (1) and (2)	256 points or less
Power failure retention (clock data*3)	Retention method	Large-capacity capacitor
	Retention time	15 days (Ambient temperature: 25°C)
Power failure retention (device)	Power failure retention capacity	Maximum 12 k word

*1: Interrupt from the intelligent function module.

*2: The value listed above indicates the number of files stored in the root folder.

*3: Clock data is retained using the power accumulated in a large-capacity capacitor incorporated into the PLC. When voltage of the large-capacity capacitor drops, clock data is no longer accurately retained. The retention period of a fully charged capacitor (electricity is conducted across the PLC for at least 30 minutes) is 15 days (ambient temperature: 25°C). How long the capacitor can hold the data depends on the operating ambient temperature. When the operating ambient temperature is high, the holding period is short.

◇ Number of device points

Items		Base	Max. number of points*	
No. of user device points	Input relay (X)	8	1024 points	
	Output relay (Y)	8	1024 points	
	Internal relay (M)	10	7680 points	
	Latch relay (L)	10	7680 points	
	Link relay (B)	16	2048 points	
	Annunciator (F)	10	128 points	
	Link special relay (SB)	16	2048 points	
	Step relay (S)	10	4096 points	
	Timer system	Timer (T)	10	512 points
		Accumulation timer system	Accumulation timer (ST)	10
	Counter system	Counter (C)	10	256 points
		Long counter (LC)	10	64 points
	Data register (D)	10	8000 points	
	Link register (W)	16	1024 points	
Link special register (SW)	16	1024 points		
No. of system device points	Special relay (SM)	10	10000 points	
	Special register (SD)	10	12000 points	
Module access device	Intelligent function module device	10	Depends on the intelligent function module.	
No. of index register points	Index register (Z)	10	20 points	
	Long index register (LZ)	10	2 points	
No. of file register points	File register (R)	10	32768 points	
	Extended file register (ER)	10	32768 points (are stored in SD memory card)	
No. of nesting points	Nesting (N)	10	15 points	
No. of pointer points	Pointer (P)	10	2048 points	
	Interrupt pointer (I)	10	178 points	
Others	Decimal constant (K)	Signed	16 bits: -32768 to +32767, 32 bits: -2147483648 to +2147483647	
		Unsigned	16 bits: 0 to 65535, 32 bits: 0 to 4294967295	
	Hexadecimal constant (H)	16 bits: 0 to FFFF, 32 bits: 0 to FFFFFFFF		
	Real constant (E)	Single precision	E-3.40282347+38 to E-1.17549435-38, 0, E1.17549435-38 to E3.40282347+38	
	Character string		Shift-JIS code max. 255 single-byte characters (256 including NULL)	

*: Maximum number of points cannot be changed. (fixed)

Performance Specifications



FX5U **FX5UC**

◇ FX5U/FX5UC CPU module performance specifications

Items		Specifications
Control system		Stored-program repetitive operation
Input/output control system		Refresh system (Direct access input/output allowed by specification of direct access input/output (DX, DY))
Programming specifications	Programming language	Ladder diagram (LD), structured text (ST), function block diagram/ladder diagram (FBD/LD), sequential function chart (SFC)*1
	Programming expansion function	Function block (FB), function (FUN), label programming (local/global)
	Constant scan	0.2 to 2000 ms (can be set in 0.1 ms increments)
	Fixed cycle interrupt	1 to 60000 ms (can be set in 1 ms increments)
	Timer performance specifications	100 ms, 10 ms, 1 ms
Operation specifications	No. of program executions	32
	No. of FB files	16 (Up to 15 for user)
	Execution type	Standby type, initial execution type, scan execution type, fixed-cycle execution type, event execution type
Command processing time	Interrupt type	Internal timer interrupt, input interruption, high-speed comparison match interrupt, interrupt by module*2
	LD X0	34 ns*3
Memory capacity	MOV D0 D1	34 ns*3
	Program capacity	64 k/128 k steps*4 (128 kbytes/256 kbytes, flash memory)
	SD memory card	Memory card capacity (SD/SDHC memory card: Max. 16 Gbytes)
	Device/label memory	150 kbytes*5
Flash memory (Flash ROM) write count	Data memory/standard ROM	5 Mbytes
		Maximum 20000 times
File storage capacity	Device/label memory	1
	Data memory P: No. of program files FB: No. of FB files	P: 32, FB: 16
	SD memory card	NZ1MEM-2GBSD: 511*6 NZ1MEM-4GBSD, NZ1MEM-8GBSD, NZ1MEM-16GBSD: 65534*6
Clock function	Display data	Year, month, day, hour, minute, second, day of week (leap year automatic detection)
	Precision	Differences per month ±45 sec./25°C (TYP)
No. of input/output points	(1) No. of input/output points	256 points or less/384 points or less*4
	(2) No. of remote I/O points	384 points or less/512 points or less*4
	Total No. of points of (1) and (2)	512 points or less
Power failure retention (clock data*7)	Retention method	Large-capacity capacitor
	Retention time	10 days (Ambient temperature: 25°C)
Power failure retention (device)	Power failure retention capacity	Maximum 12 k word*8

*1: Supported in the FX5U/FX5UC CPU module firmware version 1.220 or later. In addition, GX Works3 version 1.070Y or later is required.

*2: Interrupt from the intelligent function module and high-speed pulse input/output module.

*3: When the program capacity is 64 k steps.

*4: Supported in the FX5U/FX5UC CPU module firmware version 1.100 or later. In addition, GX Works3 version 1.047Z or later is required.

*5: Supported in the FX5U/FX5UC CPU module firmware version 1.210 or later. In addition, GX Works3 version 1.065T or later is required.

*6: The value listed above indicates the number of files stored in the root folder.

*7: Clock data is retained using the power accumulated in a large-capacity capacitor incorporated into the PLC. When voltage of the large-capacity capacitor drops, clock data is no longer accurately retained. The retention period of a fully charged capacitor (electricity is conducted across the PLC for at least 30 minutes) is 10 days (ambient temperature: 25°C). How long the capacitor can hold the data depends on the operating ambient temperature. When the operating ambient temperature is high, the holding period is short.

*8: All devices in the device (high-speed) area can be held against power failure. Devices in the device (standard) area can be held also when the optional battery is mounted.

◇ Number of device points

Items		Base	Max. number of points		
No. of user device points	Input relay (X)	8	1024 points	The total number of X and Y assigned to input/output points is up to 256 points/384 points*1.	
	Output relay (Y)	8	1024 points		
	Internal relay (M)	10	32768 points (can be changed with parameter)*2		
	Latch relay (L)	10	32768 points (can be changed with parameter)*2		
	Link relay (B)	16	32768 points (can be changed with parameter)*2		
	Annunciator (F)	10	32768 points (can be changed with parameter)*2		
	Link special relay (SB)	16	32768 points (can be changed with parameter)*2		
	Step relay (S)	10	4096 points (fixed)		
	Timer system	Timer (T)	10	1024 points (can be changed with parameter)*2	
		Accumulation timer system	10	1024 points (can be changed with parameter)*2	
	Counter system	Counter (C)	10	1024 points (can be changed with parameter)*2	
		Long counter (LC)	10	1024 points (can be changed with parameter)*2	
		Data register (D)	10	8000 points (can be changed with parameter)*2	
		Link register (W)	16	32768 points (can be changed with parameter)*2	
		Link special register (SW)	16	32768 points (can be changed with parameter)*2	
No. of system device points	Special relay (SM)	10	10000 points (fixed)		
	Special register (SD)	10	12000 points (fixed)		
Module access device	Intelligent function module device	10	65536 points (designated by U□/G□)		
No. of index register points	Index register (Z)*3	10	24 points		
	Long index register (LZ)*3	10	12 points		
No. of file register points	File register (R)	10	32768 points (can be changed with parameter)*2		
	Extended file register (ER)	10	32768 points (are stored in SD memory card)		
No. of nesting points	Nesting (N)	10	15 points (fixed)		
	Pointer (P)	10	4096 points		
No. of pointer points	Interrupt pointer (I)	10	178 points (fixed)		
	SFC block device (BL)	10	32 points		
No. of SFC points	SFC transition device (TR)	10	0 points (Used only as device comments.)		
	Others	Decimal constant (K)	Signed	16 bits: -32768 to +32767, 32 bits: -2147483648 to +2147483647	
Unsigned			16 bits: 0 to 65535, 32 bits: 0 to 4294967295		
Hexadecimal constant (H)		16 bits: 0 to FFFF, 32 bits: 0 to FFFFFFFF			
Real constant (E)		Single precision	E-3.40282347+38 to E-1.17549435-38, 0, E1.17549435-38 to E3.40282347+38		
	Character string		Shift-JIS code max. 255 single-byte characters (256 including NULL) Unicode max. 255 characters (256 including NULL)*4		

*1: Supported in the FX5U/FX5UC CPU module firmware version 1.100 or later. In addition, GX Works3 version 1.047Z or later is required.

*2: Can be changed with parameters within the capacity range of the CPU built-in memory.

*3: The sum of index register (Z) and long index register (LZ) is 24 words.

*4: Supported in the FX5U/FX5UC CPU module firmware version 1.240 or later. In addition, GX Works3 version 1.075D or later is required.

List of Instructions

◇ CPU module application instruction

Classification	Instruction symbol	Function	Compatible CPU module		
			FX5UJ	FX5U	FX5UC
Rotation	ROR(P)	16-bit data right rotation	○	○	○
	ROR(P)	Right rotation with 16-bit data carry	○	○	○
	ROL(P)	16-bit data left rotation	○	○	○
	RCL(P)	Left rotation with 16-bit data carry	○	○	○
	DROR(P)	32-bit data right rotation	○	○	○
	DROR(P)	Right rotation with 32-bit data carry	○	○	○
	DROL(P)	32-bit data left rotation	○	○	○
	DRCL(P)	Left rotation with bit data carry	○	○	○
Program branch	CJ(P)	Pointer branch	○	○	○
	GOEND	Jump to END	○	○	○
Program execution control	DI	Interrupt disable	○	○	○
	EI	Interrupt enable	○	○	○
	DI	Interrupt disable when lower than specified priority	○	○	○
	IMASK	Interrupt program mask	○	○	○
	SIMASK	Specified interrupt pointer disable/enable	○	○	○
	IRET	Return from interrupt program	○	○	○
	WDT(P)	WDT reset	○	○	○
Structured instruction	FOR	Executed (n) times between ROM instruction and NEXT instruction	○	○	○
	NEXT		○	○	○
	BREAK(P)	FOR to NEXT forced end	○	○	○
	CALL(P)	Subroutine program call	○	○	○
Data table operation	RET	Return from subroutine program	○	○	○
	SRET		○	○	○
	XCALL	Subroutine program call	○	○	○
	SFRD(P)	First-in data read from data table	○	○	○
	POP(P)	Last-in data read from data table	○	○	○
	SFWR(P)	Data write to data table	○	○	○
	FINS(P)	Data insertion to data table	○	○	○
	FDEL(P)	Data delete from data table	○	○	○
Reading/writing data	SI(P).DEVLD	Reading data from the data memory	○	○	○
	SPDEVST	Writing data to the data memory	○	○	○
File operation instructions	SPFREAD	Reading data from the specified file	—	○	○
	SPFWRITE	Writing data to the specified file	—	○	○
	SPFDELETE	Deleting the specified file	—	○	○
	SPFCOPY	Copying the specified file	—	○	○
	SPFMOVE	Moving the specified file	—	○	○
	SPFRENAME	Renaming the specified file	—	○	○
	SPFSTATUS	Acquiring the status of the specified file	—	○	○
	Extended file register operation instruction	ERREAD	Reading extended file register	○	○
ERWRITE		Writing extended file register	○	○	○
ERINIT		Batch initialization function of extended file register	○	○	○
Character string processing	LD\$=	Character string comparison LD (S1) = (S2)	○	○	○
	LD\$<>	Character string comparison LD (S1) <> (S2)	○	○	○
	LD\$>	Character string comparison LD (S1) > (S2)	○	○	○
	LD\$<=	Character string comparison LD (S1) <= (S2)	○	○	○
	LD\$<	Character string comparison LD (S1) < (S2)	○	○	○
	LD\$>=	Character string comparison LD (S1) >= (S2)	○	○	○
	AND\$=	Character string comparison AND (S1) = (S2)	○	○	○
	AND\$<>	Character string comparison AND (S1) <> (S2)	○	○	○
	AND\$>	Character string comparison AND (S1) > (S2)	○	○	○
	AND\$<=	Character string comparison AND (S1) <= (S2)	○	○	○
	AND\$<	Character string comparison AND (S1) < (S2)	○	○	○
	AND\$>=	Character string comparison AND (S1) >= (S2)	○	○	○
	OR\$=	Character string comparison OR (S1) = (S2)	○	○	○
	OR\$<>	Character string comparison OR (S1) <> (S2)	○	○	○
	OR\$>	Character string comparison OR (S1) > (S2)	○	○	○
	OR\$<=	Character string comparison OR (S1) <= (S2)	○	○	○
	OR\$<	Character string comparison OR (S1) < (S2)	○	○	○
	OR\$>=	Character string comparison OR (S1) >= (S2)	○	○	○
	\$+(P)	Combination of character strings	○	○	○
	\$MOV(P)	Transfer of character string	○	○	○
	\$MOV(P)_WS	Transferring Unicode string data	—	○	○
	BINDA(P)_LU	BIN 16-bit data → Decimal ASCII conversion	○	○	○
	DBINDA(P)_LU	BIN 32-bit data → Decimal ASCII conversion	○	○	○

○: Supported, —: Not supported

For sequence instructions and basic instructions, refer to manuals.

Classification	Instruction symbol	Function	Compatible CPU module		
			FX5UJ	FX5U	FX5UC
Character string processing	ASCI(P)	HEX code data → ASCII conversion	○	○	○
	STR(P)_LU	BIN 16-bit data → Character string conversion	○	○	○
	DSTR(P)_LU	BIN 32-bit data → Character string conversion	○	○	○
	ESTR(P)	Single precision actual number →	○	○	○
	DESTR(P)	Character string conversion	○	○	○
	WS2S,JIS(P)	Converting Unicode character string to Shift JIS character string	—	○	○
	SJIS2WS(P)	Converting shift JIS character string to Unicode character string (without byte order mark)	—	○	○
	SJIS2WSB(P)	Converting shift JIS character string to Unicode (with byte order mark)	—	○	○
	LEN(P)	Detection of character string length	○	○	○
	RIGHT(P)	Extraction from right side of character string	○	○	○
	LEFT(P)	Extraction from left side of character string	○	○	○
	MIDR(P)	Extraction of any part from the middle of character string	○	○	○
	MIDW(P)	Replacement of any part in the middle of character string	○	○	○
	INSTR(P)	Character string search	○	○	○
	STRINS(P)	Character string insertion	○	○	○
Actual number	STRDEL(P)	Character string deletion	○	○	○
	LDE\$=	Single precision actual number comparison LDE (S1) = (S2)	○	○	○
	LDE\$<>	Single precision actual number comparison LDE (S1) <> (S2)	○	○	○
	LDE\$>	Single precision actual number comparison LDE (S1) > (S2)	○	○	○
	LDE\$<=	Single precision actual number comparison LDE (S1) <= (S2)	○	○	○
	LDE\$<	Single precision actual number comparison LDE (S1) < (S2)	○	○	○
	LDE\$>=	Single precision actual number comparison LDE (S1) >= (S2)	○	○	○
	ANDE\$=	Single precision actual number comparison ANDE (S1) = (S2)	○	○	○
	ANDE\$<>	Single precision actual number comparison ANDE (S1) <> (S2)	○	○	○
	ANDE\$>	Single precision actual number comparison ANDE (S1) > (S2)	○	○	○
	ANDE\$<=	Single precision actual number comparison ANDE (S1) <= (S2)	○	○	○
	ANDE\$<	Single precision actual number comparison ANDE (S1) < (S2)	○	○	○
	ANDE\$>=	Single precision actual number comparison ANDE (S1) >= (S2)	○	○	○
	ORE\$=	Single precision actual number comparison ORE (S1) = (S2)	○	○	○
	ORE\$<>	Single precision actual number comparison ORE (S1) <> (S2)	○	○	○
	ORE\$>	Single precision actual number comparison ORE (S1) > (S2)	○	○	○
	ORE\$<=	Single precision actual number comparison ORE (S1) <= (S2)	○	○	○
	ORE\$<	Single precision actual number comparison ORE (S1) < (S2)	○	○	○
	ORE\$>=	Single precision actual number comparison ORE (S1) >= (S2)	○	○	○
	DECOMP(P)	Single precision actual number comparison	○	○	○
	DEZCP(P)	Binary floating point bandwidth comparison	○	○	○
	E+(P)	Single precision actual number addition	○	○	○
	E-(P)	Single precision actual number subtraction	○	○	○
	DEADD(P)	Single precision actual number addition	○	○	○
	DESUB(P)	Single precision actual number subtraction	○	○	○
	E*(P)	Single precision actual number multiplication	○	○	○
	E/(P)	Single precision actual number division	○	○	○
	DEMUL(P)	Single precision actual number multiplication	○	○	○
	DEDIV(P)	Single precision actual number division	○	○	○
	INT2FLT(P)	Signed BIN 16-bit data → Single precision actual number conversion	○	○	○
	UINT2FLT(P)	Unsigned BIN 16-bit data → Single precision actual number conversion	○	○	○
	DINT2FLT(P)	Signed BIN 32-bit data → Single-precision real number conversion	○	○	○
	UDINT2FLT(P)	Unsigned BIN 32-bit data → Single precision actual number conversion	○	○	○
	EVAL(P)	Character string →	○	○	○
	DEVAL(P)	Single precision actual number conversion	○	○	○
	DEBCD(P)	Binary floating point → Decimal floating point conversion	○	○	○
	DEBIN(P)	Decimal floating point → Binary floating point conversion	○	○	○
	ENEG(P)	Reverse of single precision actual number sign	○	○	○
	DENEG(P)		○	○	○
	EMOV(P)	Transfer of single precision actual number data	○	○	○
	DEMOV(P)		○	○	○
	SIN(P)	Single precision actual number SIN operation	○	○	○
	DSIN(P)		○	○	○
	COS(P)	Single precision actual number COS operation	○	○	○
	DCOS(P)		○	○	○
TAN(P)	Single precision actual number TAN operation	○	○	○	
DTAN(P)		○	○	○	
ASIN(P)	Single precision actual number SIN ⁻¹ operation	○	○	○	
DASIN(P)		○	○	○	

List of Instructions

Classification	Instruction symbol	Function	Compatible CPU module			
			FX5U	FX5U	FX5UC	
Actual number	ACOS(P)	Single precision actual number COS ⁻¹ Operation	○	○	○	
	DAACOS(P)		○	○	○	
	ATAN(P)	Single precision accuracy TAN ⁻¹ operation	○	○	○	
	DATAN(P)		○	○	○	
	RAD(P)	Single precision actual number angle →	○	○	○	
	DRAD(P)	Radian conversion	○	○	○	
	DEG(P)	Single precision actual number radian →	○	○	○	
	DDEG(P)	Angle conversion	○	○	○	
	DESQR(P)	Square root of single precision actual number	○	○	○	
	ESQRT(P)		○	○	○	
	EXP(P)		Index operation of single precision actual number	○	○	○
	DEXP(P)	○		○	○	
	LOG(P)	Inferior logarithm operation of single precision actual number		○	○	○
	DLOGE(P)		○	○	○	
	POW(P)		Exponentiation operation of single precision actual number	○	○	○
	LOG10(P)	○		○	○	
	DLOG10(P)	○		○	○	
	EMAX(P)	Search for maximum value of single precision actual number	○	○	○	
	EMIN(P)	Search for minimum value of single precision actual number	○	○	○	
	Random number	RND(P)	Random number generation	○	○	○
	Index register operation	ZPUSH(P)	Collective saving of index register	○	○	○
ZPOP(P)		Corrective return of index register	○	○	○	
ZPUSH(P)		Selection and saving of index register/long index register	○	○	○	
ZPOP(P)		Selection and return of index register/long index register	○	○	○	
Data control	LIMIT(P)_(L,U)	BIN 16-bit data upper-/lower-limit control	○	○	○	
	DLIMIT(P)_(L,U)	BIN 32-bit data upper-/lower-limit control	○	○	○	
	BAND(P)_(L,U)	BIN 16-bit data dead band control	○	○	○	
	DBAND(P)_(L,U)	BIN 32-bit data dead band control	○	○	○	
	ZONE(P)_(L,U)	BIN 16-bit data zone control	○	○	○	
	DZONE(P)_(L,U)	BIN 32-bit data zone control	○	○	○	
	SCL(P)_(L,U)	BIN 16-bit unit scaling (point-specific coordinate data)	○	○	○	
	DSCL(P)_(L,U)	BIN 32-bit unit scaling (point-specific coordinate data)	○	○	○	
Special timer	TTMR	Teaching timer	○	○	○	
	STMR	Special function timer	○	○	○	
Special counter	UDCNTF	Signed 32-bit up/down counter	○	○	○	
Shortcut control	ROTC	Rotary table shortcut control	○	○	○	
Inclination signal	RAMPF	Control inclination signal	○	○	○	
Pulse system	SPD	Measurement of BIN 16-bit pulse density	○	○	○	
	DSPD	Measurement of BIN 32-bit pulse density	○	○	○	
	PLSY	BIN 16-bit pulse output	○	○	○	
	DPLSY	BIN 32-bit pulse output	○	○	○	
	PWM	BIN 16 pulse width modulation	○	○	○	
Matrix input	MTR	Matrix input	○	○	○	
Initial state	IST	Initial state	○	○	○	
Drum sequence	ABSD	BIN 16-bit data absolute method	○	○	○	
	DABSD	BIN 32-bit data absolute method	○	○	○	
	INCD	Relative method	○	○	○	
Check code	CCD(P)	Check code	○	○	○	
Data processing instruction	SERMM(P)	Data processing instruction	○	○	○	
	DSERMM(P)	32-bit data search	○	○	○	
	SUM(P)	16-bit data bit check	○	○	○	
	DSUM(P)	32-bit data bit check	○	○	○	
	BON(P)	Bit detection of 16-bit data	○	○	○	
	DBON(P)	Bit detection of 32-bit data	○	○	○	
	MAX(P)_(L,U)	Search for maximum value of 16-bit data	○	○	○	
	DMAX(P)_(L,U)	Search for maximum value of 32-bit data	○	○	○	
	MIN(P)_(L,U)	Search for minimum value of 16-bit data	○	○	○	
	DMIN(P)_(L,U)	Search for minimum value of 32-bit data	○	○	○	
	SORTTBL(U)	16-bit data sort	○	○	○	
	SORTTBL2(U)	16-bit data alignment 2	○	○	○	
	DSORTTBL2(U)	32-bit data alignment 2	○	○	○	
	WSUM(P)_(L,U)	16-bit data total value calculation	○	○	○	
	DWSUM(P)_(L,U)	32-bit data total value calculation	○	○	○	
	MEAN(P)_(L,U)	16-bit data average value calculation	○	○	○	
	DMEAN(P)_(L,U)	32-bit data average value calculation	○	○	○	
	SQRT(P)	Calculation of 16-bit square root	○	○	○	
	DSQRT(P)	Calculation of 32-bit square root	○	○	○	
	CRC(P)	CRC calculation	○	○	○	

Classification	Instruction symbol	Function	Compatible CPU module		
			FX5U	FX5U	FX5UC
Indirect address read	ADRSET(P)	Indirect address read	○	○	○
	TRD(P)	Clock data read	○	○	○
For clock	TWR(P)	Clock data write	○	○	○
	TADD(P)	Addition of clock data	○	○	○
	TSUB(P)	Subtraction of clock data	○	○	○
	HTOS(P)	16-bit data conversion of time data (hour/minute/second → second)	○	○	○
	DHTOS(P)	32-bit data conversion of time data (hour/minute/second → second)	○	○	○
	STOH(P)	16-bit data conversion of time data (second → hour/minute/second)	○	○	○
	DSTOH(P)	32-bit data conversion of time data (second → hour/minute/second)	○	○	○
	LDDT\$=	Date comparison LDDT (S1) = (S2)	○	○	○
	LDDT\$<	Date comparison LDDT (S1) < (S2)	○	○	○
	LDDT\$>	Date comparison LDDT (S1) > (S2)	○	○	○
	LDDT\$<=	Date comparison LDDT (S1) <= (S2)	○	○	○
	LDDT\$<	Date comparison LDDT (S1) < (S2)	○	○	○
	LDDT\$>=	Date comparison LDDT (S1) >= (S2)	○	○	○
	ANDDT\$=	Date comparison ANDDT (S1) = (S2)	○	○	○
	ANDDT\$<	Date comparison ANDDT (S1) < (S2)	○	○	○
	ANDDT\$>	Date comparison ANDDT (S1) > (S2)	○	○	○
	ANDDT\$<=	Date comparison ANDDT (S1) <= (S2)	○	○	○
	ANDDT\$<	Date comparison ANDDT (S1) < (S2)	○	○	○
	ANDDT\$>=	Date comparison ANDDT (S1) >= (S2)	○	○	○
	ORDT\$=	Date comparison ORDT (S1) = (S2)	○	○	○
	ORDT\$<	Date comparison ORDT (S1) < (S2)	○	○	○
	ORDT\$>	Date comparison ORDT (S1) > (S2)	○	○	○
	ORDT\$<=	Date comparison ORDT (S1) <= (S2)	○	○	○
	ORDT\$<	Date comparison ORDT (S1) < (S2)	○	○	○
	ORDT\$>=	Date comparison ORDT (S1) >= (S2)	○	○	○
	LDTM\$=	Time comparison LDTM (S1) = (S2)	○	○	○
	LDTM\$<	Time comparison LDTM (S1) < (S2)	○	○	○
	LDTM\$>	Time comparison LDTM (S1) > (S2)	○	○	○
	LDTM\$<=	Time comparison LDTM (S1) <= (S2)	○	○	○
	LDTM\$<	Time comparison LDTM (S1) < (S2)	○	○	○
	LDTM\$>=	Time comparison LDTM (S1) >= (S2)	○	○	○
	ANDTM\$=	Time comparison ANDTM (S1) = (S2)	○	○	○
	ANDTM\$<	Time comparison ANDTM (S1) < (S2)	○	○	○
	ANDTM\$>	Time comparison ANDTM (S1) > (S2)	○	○	○
	ANDTM\$<=	Time comparison ANDTM (S1) <= (S2)	○	○	○
	ANDTM\$<	Time comparison ANDTM (S1) < (S2)	○	○	○
	ANDTM\$>=	Time comparison ANDTM (S1) >= (S2)	○	○	○
	ORTM\$=	Time comparison ORTM (S1) = (S2)	○	○	○
	ORTM\$<	Time comparison ORTM (S1) < (S2)	○	○	○
ORTM\$>	Time comparison ORTM (S1) > (S2)	○	○	○	
ORTM\$<=	Time comparison ORTM (S1) <= (S2)	○	○	○	
ORTM\$<	Time comparison ORTM (S1) < (S2)	○	○	○	
ORTM\$>=	Time comparison ORTM (S1) >= (S2)	○	○	○	
Timing measurement	TCMP(P)	Clock data comparison	○	○	○
	TZCP(P)	Clock data bandwidth comparison	○	○	○
Module access	DUTY	Timing pulse generation	○	○	○
	HOURM	Hour meter (BIN 16-bit data)	○	○	○
Logging	DHOURM	Hour meter (BIN 32-bit data)	○	○	○
	REF(P)	I/O refresh	○	○	○
	RFS(P)		○	○	○
	FROM(P)	Read of 1-word data from other module (16-bit specified)	○	○	○
	DFROM(P)	Read of 2-word data from other module (16-bit specified)	○	○	○
	TO(P)	Write of 1-word data from other module (16-bit specified)	○	○	○
	DTO(P)	Write of 2-word data from other module (16-bit specified)	○	○	○
	FROMD(P)	Read of 1-word data from other module (32-bit specified)	○	○	○
	DFROMD(P)	Read of 2-word data from other module (32-bit specified)	○	○	○
	TOD(P)	Write of 1-word data from other module (32-bit specified)	○	○	○
DTOD(P)	Write of 2-word data from other module (32-bit specified)	○	○	○	
Real-time monitor function	LOGTRG	Setting trigger logging	○	○	○
	LOGTRGR	Resetting trigger logging	○	○	○
	RTM	Real-time monitor function	○	○	○

○: Supported, --: Not supported

For sequence instructions and basic instructions, refer to manuals.

◇ Step ladder instruction

Classification	Instruction symbol	Function	Compatible CPU module		
			FX5UJ	FX5U	FX5UC
Step ladder	STL	Start of step ladder	○	○	○
	RETSTL	End of step ladder	○	○	○

◇ Ethernet instruction

Classification	Instruction symbol	Function	Compatible CPU module		
			FX5UJ	FX5U	FX5UC
Built-in Ethernet function instruction	SP.SOCOPEN	Connection establishment	○	○	○
	SP.SOCLOSE	Connection disconnection	○	○	○
Socket Communication function	SP.SOCRCV	Read of received data during END processing	○	○	○
	SP.SOCSND	Data transmission	○	○	○
	SP.SOCCINF	Read of connection information	○	○	○
	SP.SOGRDATA	Read of received data of socket communication	○	○	○
Communication protocol support function	SPECPRCTL	Execution of registration protocol of communication protocol support function	○	○	○
SLMP frame transmission	SP.SLMPNSD	SLMP message transmission to SLMP-compatible device	○	○	○
File transfer function	SP.FTPPUT	Sending FTP client files	—	○	○
	SP.FTPGET	Retrieving FTP client files	—	○	○
Ethernet module	GP.OPEN	Connection establishment	○	○	○
	GP.CLOSE	Connection disconnection	○	○	○
	GP.SOCRCV	Read of received data	○	○	○
	GP.SOCSND	Data transmission	○	○	○

◇ PID control instruction

Classification	Instruction symbol	Function	Compatible CPU module		
			FX5UJ	FX5U	FX5UC
PID control	PID	PID operation	○	○	○

◇ SFC program instructions

Classification	Instruction symbol	Function	Compatible CPU module		
			FX5UJ	FX5U	FX5UC
SFC Control Instructions	LD[S□/BL□S□]	Checking the status of a step	—	○	○
	LD[□S□/BL□S□]		—	○	○
	AND[S□/BL□S□]		—	○	○
	ANI[S□/BL□S□]		—	○	○
	OR[S□/BL□S□]		—	○	○
	ORI[S□/BL□S□]		—	○	○
	LD[BL□]		—	○	○
	LD[BL□]		—	○	○
	AND[BL□]	Checking the status of a block	—	○	○
	ANI[BL□]		—	○	○
	OR[BL□]		—	○	○
	ORI[BL□]		—	○	○
	MOV(P) [KnS□/BL□KnS□]	Batch-reading the status of steps	—	○	○
	DMOV(P) [KnS□/BL□KnS□]		—	○	○
	BMOV(P) [KnS□/BL□KnS□]		—	○	○
	SET[BL□]	Starting a block	—	○	○
	RST[BL□]	Ending a block	—	○	○
	SET[S□/BL□S□]	Activating a step	—	○	○
	RST[S□/BL□S□]	Deactivating a step	—	○	○
	OUT[S□/BL□S□]	Activating/deactivating a step	—	○	○
ZRST(P)S□/BL□S□]	Batch-deactivating a step	—	○	○	
SFC Dedicated Instruction	TRAN	Creating a dummy transition condition	—	○	○

◇ List of module dedicated instructions

Classification	Instruction symbol	Function	Compatible CPU module		
			FX5UJ	FX5U	FX5UC
Network Common	GP.READ	Reading data from the PLC of another station	○	○	○
	GP.SPREAD	Reading data from the PLC of another station (A read notice is issued.)	○	○	○
	GP.WRITE	Writing data to the PLC of another station	○	○	○
	GP.SWRITE	Writing data to the PLC of another station (A write notice is issued.)	○	○	○
	GP.SEND	Transmission of data to the PLC of another station	○	○	○
	GP.RECV	Reception of data from the PLC of another station	○	○	○
CC-Link IE TSN	G(P).UINI	Own station number/IP address setting	—	○	○
CC-Link IE Field Network	G(P).CCPASET	Setting parameters	○	○	○
	G(P).UINI	Setting the station number to own station	○	○	○
High-speed counter	DHSCS	32-bit data comparison set	○	○	○
	DHSCR	32-bit comparison reset	○	○	○
	DHSZ	32-bit data bandwidth comparison	○	○	○
	HIOEN(P)	Start and stop of 16-bit data high-speed input/output function	○	○	○
	DHIOEN(P)	Start and stop of 32-bit data high-speed input/output function	○	○	○
High-speed transfer of current value	HCMOV(P)	High-speed transfer of 16-bit data current value	○	○	○
	DHCMOV(P)	High-speed transfer of 32-bit data current value	○	○	○
External device communication	RS2	Serial data transfer 2	○	○	○
Inverter communication	IVCK	Inverter operation monitor	○	○	○
	IVDR	Inverter operation control	○	○	○
	IVRD	Inverter parameter read	○	○	○
	IWR	Inverter parameter write	○	○	○
	IVBWR	Inverter parameter batch write	○	○	○
	IVMC	Multiple commands of inverter	○	○	○
MODBUS	ADPRW	MODBUS data read/write	○	○	○
Communication protocol support function	S(P).CPRTCL	Execution of communication protocol registered by engineering tool	○	○	○
Positioning	DSZR	Home position return with 16-bit data dog search	○	○	○
	DDSZR	Home position return with 32-bit data dog search	○	○	○
	DVIT	16-bit data interrupt positioning	○	○	○
	DDVIT	32-bit data interrupt positioning	○	○	○
	TBL	Positioning by 1-table operation	○	○	○
	DRVITBL	Positioning by multiple-table operation	○	○	○
	DRVMUL	Multiple axis simultaneous drive positioning	○	○	○
	DABS	32-bit data ABS current value read	○	○	○
	PLSV	16-bit data variable speed pulse	○	○	○
	DPLSV	32-bit data variable speed pulse	○	○	○
	DRVI	16-bit data relative positioning	○	○	○
	DDRVI	32-bit data relative positioning	○	○	○
	DRVA	16-bit data absolute positioning	○	○	○
	DDRVA	32-bit data absolute positioning	○	○	○
	G.ABRST1 G.ABRST2	Absolute position restoration of specified axis	○	○	○
GP.PSTR1 GP.PSTR2	Starting the positioning of specified axis	○	○	○	
GP.TEACH1 GP.TEACH2	Teaching of specified axis	○	○	○	
GP.PFWRT	Backing up the module	○	○	○	
GP.PINT	Module initialization	○	○	○	
BFM split read/write	RBFM	BFM split read	—	○	○
	WBFM	BFM split write	—	○	○

○: Supported, —: Not supported

For sequence instructions and basic instructions, refer to manuals.

Special Devices

Typical special relays and special registers are described below.
For details, refer to manual.

List of special relays

◇ Diagnostic information

No.	Name	FX5UJ	FX5U	FX5UC
SM0	Latest self diagnosis error (including annunciator ON)	○	○	○
SM1	Latest self diagnosis error (not including annunciator ON)	○	○	○
SM50	Error reset	○	○	○
SM51	Battery low latch	—	○	○
SM52	Battery low	—	○	○
SM53	AG/DC DOWN	○	○	○
SM56	Operation error	○	○	○
SM61	I/O module verify error	○	○	○
SM62	Annunciator	○	○	○

◇ System information

No.	Name	FX5UJ	FX5U	FX5UC
SM203	STOP contact	○	○	○
SM204	PAUSE contact	○	○	○
SM210	Clock data set request	○	○	○
SM211	Clock data set error	○	○	○
SM213	Clock data read request	○	○	○

◇ SFC information

No.	Name	FX5UJ	FX5U	FX5UC
SM320	Presence/absence of SFC program	—	○	○
SM321	Start/stop SFC program	—	○	○
SM322	SFC program startup status	—	○	○
SM323	Presence/absence of continuous transition for entire block	—	○	○
SM324	Continuous transition prevention flag	—	○	○
SM327	Output mode at execution of the END step	—	○	○
SM328	Clear processing mode when the sequence reaches the END step	—	○	○
SM4301	FX3 compatible transition operation mode setting status	—	○	○

◇ System clock

No.	Name	FX5UJ	FX5U	FX5UC
SM400	Always ON	○	○	○
SM401	Always OFF	○	○	○
SM402	After RUN, ON for one scan only	○	○	○
SM403	After RUN, OFF for one scan only	○	○	○
SM409	0.01 sec. clock	○	○	○
SM410	0.1 sec. clock	○	○	○
SM411	0.2 sec. clock	○	○	○
SM412	1 sec. clock	○	○	○
SM413	2 sec. clock	○	○	○
SM414	2n sec. clock	○	○	○
SM415	2n millisecond clock	○	○	○

◇ Instruction related

No.	Name	FX5UJ	FX5U	FX5UC
SM699	Dedicated instruction skip flag	○	○	○
SM700	Carry flag	○	○	○
SM701	Output character count switching	○	○	○
SM703	Sort order	○	○	○
SM704	Block comparison	○	○	○
SM709	DT/TM instruction improper data detection	○	○	○
SM753	File being accessed	○	○	○

◇ For serial communication

No.	Name	FX5UJ	FX5U	FX5UC
SM8500	Serial communication error (ch1)	—	○	○
SM8560	Data transfer delayed (ch1)	—	○	○
SM8561	Data transfer flag (ch1)	—	○	○
SM8562	Receive completion flag (ch1)	—	○	○
SM8563	Carrier detection flag (ch1)	—	○	○
SM8564	Data set ready flag (ch1)	—	○	○
SM8565	Time-out check flag (ch1)	—	○	○
SM8740	Station No. setting SD latch enabled (ch1)	—	○	○
SM8800	MODBUS RTU communication (ch1)	—	○	○
SM8801	Retry (ch1)	—	○	○
SM8802	Timeout (ch1)	—	○	○
SM8861	Host station No. setting SD latch enabled (ch1)	—	○	○
SM8920	Inverter communication (ch1)	—	○	○
SM8921	IVBWR instruction error (ch1)	—	○	○
SM9040	Data communication error (Master station)	○	○	○
SM9041	Data communication error (Slave station No.1)	○	○	○

◇ FX compatible area

No.	Name	FX5UJ	FX5U	FX5UC
SM8000	RUN monitor NO contact	○	○	○
SM8001	RUN monitor NC contact	○	○	○
SM8002	Initial pulse NO contact	○	○	○
SM8003	Initial pulse NC contact	○	○	○
SM8004	Error occurrence	○	○	○
SM8005	Battery voltage low	—	○	○
SM8006	Battery error latch	—	○	○
SM8007	Momentary power failure	○	○	○
SM8008	Power failure detected	○	○	○
SM8011	10 msec clock pulse	○	○	○
SM8012	100 msec clock pulse	○	○	○
SM8013	1 sec clock pulse	○	○	○
SM8014	1 min clock pulse	○	○	○
SM8015	Clock stop and preset	○	○	○
SM8016	Time read display is stopped	○	○	○
SM8017	±30 seconds correction	○	○	○
SM8019	Real time clock error	○	○	○
SM8020	Zero	○	○	○
SM8021	Borrow	○	○	○
SM8022	Carry	○	○	○
SM8023	Real time clock access error	○	○	○
SM8026	Operation stop mode with one ramp output instruction	○	○	○
SM8029	Completion of instruction execution	○	○	○
SM8031	Non-latch memory all clear	○	○	○
SM8032	Latch memory all clear	○	○	○
SM8033	Memory hold function when RUN → STOP	○	○	○
SM8034	All outputs prohibited	○	○	○
SM8039	Constant scan mode	○	○	○
SM8040	For STL: Transition prohibited	○	○	○
SM8041	For STL: Start of operation during automatic operation	○	○	○
SM8042	For STL: Start pulse	○	○	○
SM8043	For STL: Completion of home position return	○	○	○
SM8044	For STL: Home position condition	○	○	○
SM8045	For STL: All output reset prohibited during mode switch	○	○	○
SM8046	For STL: With STL state ON	○	○	○
SM8047	For STL: STL monitor (SD8040 to SD8047) enabled	○	○	○
SM8048	Annunciator operation	○	○	○
SM8049	ON annunciator minimum number enabled	○	○	○
SM8063	Serial communication error1 (ch1)	○	○	○
SM8067	Operation error	○	○	○
SM8068	Operation error latch	○	○	○

○: Supported, —: Not supported

List of special registers

◇ Diagnostic information

No.	Name	FX5UJ	FX5U	FX5UC
SD0	Latest self diagnosis error code	○	○	○
SD1	Clock time for self diagnosis error occurrence (Year)	○	○	○
SD2	Clock time for self diagnosis error occurrence (Month)	○	○	○
SD3	Clock time for self diagnosis error occurrence (Day)	○	○	○
SD4	Clock time for self diagnosis error occurrence (Hour)	○	○	○
SD5	Clock time for self diagnosis error occurrence (Minute)	○	○	○
SD6	Clock time for self diagnosis error occurrence (Second)	○	○	○
SD7	Clock time for self diagnosis error occurrence (Day Week)	○	○	○

◇ System information

No.	Name	FX5UJ	FX5U	FX5UC
SD203	CPU Status	○	○	○
SD210	Clock Data (Year)	○	○	○
SD211	Clock Data (Month)	○	○	○
SD212	Clock Data (Day)	○	○	○
SD213	Clock Data (Hour)	○	○	○
SD214	Clock Data (Minute)	○	○	○
SD215	Clock Data (Second)	○	○	○
SD216	Clock Data (Day Week)	○	○	○

◇ System clock

No.	Name	FX5UJ	FX5U	FX5UC
SD412	One second counter	○	○	○
SD414	2n second clock setting	○	○	○
SD415	2n ms second clock setting	○	○	○
SD420	Scan counter	○	○	○

◇ Scan information

No.	Name	FX5UJ	FX5U	FX5UC
SD500	Execution program number	○	○	○
SD520	Current scan time (ms)	○	○	○
SD521	Current scan time (μs)	○	○	○
SD522	Minimum scan time (ms)	○	○	○
SD523	Minimum scan time (μs)	○	○	○
SD524	Maximum scan time (ms)	○	○	○
SD525	Maximum scan time (μs)	○	○	○

◇ For serial communication

No.	Name	FX5UJ	FX5U	FX5UC
SD8500	Serial communication error code (ch1)	—	○	○
SD8501	Serial communication error details (ch1)	—	○	○
SD8502	Serial communication setting (ch1)	—	○	○
SD8503	Serial communication operational mode (ch1)	—	○	○

◇ For built-in Ethernet

No.	Name	FX5UJ	FX5U	FX5UC
SD10050	Local node IP address [low-order]	○	○	○
SD10051	Local node IP address [high-order]	○	○	○
SD10060	Subnet mask [low-order]	○	○	○
SD10061	Subnet mask [high-order]	○	○	○
SD10064	Default gateway IP address [low-order]	○	○	○
SD10065	Default gateway IP address [high-order]	○	○	○
SD10074	Local node MAC address	○	○	○
SD10075	Local node MAC address	○	○	○
SD10076	Local node MAC address	○	○	○
SD10082	Communication speed setting	○	○	○
SD10084	MELSOFT connection TCP port No.	○	○	○
SD10086	MELSOFT direct connection port No.	○	○	○

◇ FX compatible area

No.	Name	FX5UJ	FX5U	FX5UC
SD8000	Watch dog timer	○	○	○
SD8001	PLC type and system version	○	○	○
SD8005	Battery voltage	—	○	○
SD8006	Low battery voltage	—	○	○
SD8007	Power failure count	○	○	○
SD8008	Power failure detection period	○	○	○
SD8010	Current scan time	○	○	○
SD8011	Minimum scan time	○	○	○
SD8012	Maximum scan time	○	○	○
SD8013	RTC: Seconds	○	○	○
SD8014	RTC: Minute data	○	○	○
SD8015	RTC: Hour data	○	○	○
SD8016	RTC: Day data	○	○	○
SD8017	RTC: Month data	○	○	○
SD8018	RTC: Year data	○	○	○
SD8019	RTC: Day of week data	○	○	○
SD8039	Constant scan duration	○	○	○
SD8040	ON state number 1	○	○	○
SD8041	ON state number 2	○	○	○
SD8042	ON state number 3	○	○	○
SD8043	ON state number 4	○	○	○
SD8044	ON state number 5	○	○	○
SD8045	ON state number 6	○	○	○
SD8046	ON state number 7	○	○	○
SD8047	ON state number 8	○	○	○
SD8049	Lowest active Annunciator	○	○	○
SD8063	Serial communication error code (ch1)	○	○	○
SD8067	Operation error	○	○	○

General, Power Supply, Input/Output Specifications

◇ General specifications

Item	Specifications				
	FX5UJ		FX5U/FX5UC		
Operating ambient temperature*1	0 to 55°C (32 to 131°F), non-freezing		-20 to 55°C (-4 to 131°F), non-freezing*2*3*4		
Storage ambient temperature	-25 to 75°C (-13 to 167°F), non-freezing				
Operating ambient humidity	5 to 95%RH, non-condensation*5				
Storage ambient humidity	5 to 95%RH, non-condensation				
Vibration resistance*6*7	Installed on DIN rail	Frequency	Acceleration	Half amplitude	Sweep count 10 times each in X, Y, Z directions (80 min in each direction)
		5 to 8.4 Hz	—	1.75 mm	
	Direct installing*8	8.4 to 150 Hz	4.9 m/s ²	—	
		5 to 8.4 Hz	—	3.5 mm	
		8.4 to 150 Hz	9.8 m/s ²	—	
Shock resistance*6	147 m/s ² . Action time: 11 ms, 3 times by half-sine pulse in each direction X, Y, and Z				
Noise durability*9	By noise simulator at noise voltage of 1000 Vp-p, noise width of 1 ms and period of 30 to 100 Hz				
Grounding	Class D grounding (grounding resistance: 100 Ω or less) <Common grounding with a heavy electrical system is not allowed.> *10				
Working atmosphere	Free from corrosive or flammable gas and excessive conductive dust				
Operating altitude*11	0 to 2000 m				
Installation location	Inside a control panel*12				
Overvoltage category*13	II or less				
Pollution degree*14	2 or less				

- *1 : The simultaneous ON ratio of available PLC inputs or outputs changes with respect to the ambient temperature. For details, refer to the manual.
- *2 : 0 to 55°C for products manufactured before June 2016. For intelligent function modules, refer to the manual of each product.
The following products cannot be used when the ambient temperature is less than 0°C:
FX5-40SSC-S, FX5-80SSC-S, FX5-CNV-BUS, FX5-CNV-BUSC, battery (FX3U-32BL), SD memory cards (NZ1MEM-2GBSD, NZ1MEM-4GBSD, NZ1MEM-8GBSD, NZ1MEM-16GBSD, L1MEM-2GBSD and L1MEM-4GBSD), FX3 extension modules, terminal blocks and I/O cables (FX-16E-500CAB-S, FX-16E-□CAB and FX-16E-□CAB-R)
- *3 : The specifications are different in the use at less than 0°C. For details, refer to the manual.
- *4 : When using the FX5-CCLGN-MS manufactured in December 2020 or earlier, the operating ambient temperature is -20 to 50°C.
- *5 : When used in a low-temperature environment, use in an environment with no sudden temperature changes. If there are sudden temperature changes because of opening/closing of the control panel or other reasons, condensation may occur, which may cause a fire, fault, or malfunction. Furthermore, use an air conditioner in dehumidifier mode to prevent condensation.
- *6 : The criterion is shown in IEC61131-2.
- *7 : When the system has equipment which specification values are lower than above mentioned vibration resistance specification values, the vibration resistance specification of the whole system is corresponding to the lower specification.
- *8 : Direct installation of FX5UC is not possible.
- *9 : When using the FX5 safety extension modules under the severe noise environment, implement external noise countermeasures with a surge absorber and ferrite core.
- *10 : For grounding, refer to manuals of each product.
- *11 : The PLC cannot be used at a pressure higher than the atmospheric pressure to avoid damage.
- *12 : The programmable controller is assumed to be installed in an environment equivalent to indoor.
- *13 : This indicates the section of the power supply to which the equipment is assumed to be connected between the public electrical power distribution network and the machinery within premises. Category II applies to equipment for which electrical power is supplied from fixed facilities. The surge voltage withstand level for up to the rated voltage of 300 V is 2500 V.
- *14 : This index indicates the degree to which conductive material is generated in the environment in which the equipment is used. Pollution level 2 is when only non-conductive pollution occurs. Temporary conductivity caused by condensation must be expected occasionally.

◇ Power supply specifications

● Power supply specifications (FX5UJ CPU module)

Item	Specifications		
	FX5UJ-24M□	FX5UJ-40M□	FX5UJ-60M□
Rated voltage	100 to 240 V AC		
Voltage fluctuation range	-15%, +10%		
Frequency rating	50/60 Hz		
Allowable instantaneous power failure time*1	Operation can be continued upon occurrence of instantaneous power failure for 10 ms or less. When the supply voltage is 200 V AC or higher, the time can be change to 10 to 100 ms by editing the user program.		
Power fuse	250 V, 3.15 A Time-lag fuse		
Rush current	25 A max. 5 ms or less/100 V AC 50 A max. 5 ms or less/200 V AC	30 A max. 5 ms or less/100 V AC 50 A max. 5 ms or less/200 V AC	
Power consumption*2	30 W	32 W	35 W
24 V DC service power supply capacity*3*4	Supply capacity when 24 V DC service power supply is used for input circuit of the CPU module	400 mA	400 mA
	Supply capacity when external power supply is used for input circuit of the CPU module	460 mA	550 mA

- *1 : The allowable instantaneous power failure time does not apply to the FX5 safety extension module.
- *2 : This item shows value when all 24 V DC service power supplies are used in the maximum configuration connectable to the CPU module. (The current of the input circuit is included.)
- *3 : When I/O modules are connected, they consume current from the 24 V DC service power supply.
For details about the service power supply, refer to the manual.
- *4 : The FX5 safety extension module cannot use a 24 V DC service power supply.

For the general specifications for each model, refer to each manual.

General, Power Supply, Input/Output Specifications

● Power supply specifications (FX5U CPU module, AC power supply type)

Item	Specifications		
	FX5U-32M□/E□	FX5U-64M□/E□	FX5U-80M□/E□
Rated voltage	100 to 240 V AC		
Voltage fluctuation range	-15%, +10%		
Frequency rating	50/60 Hz		
Allowable instantaneous power failure time	Operation can be continued upon occurrence of instantaneous power failure for 10 ms or less. If the supply voltage is 200 V AC system, change in the range from 10 to 100 ms can be made by the user program.		
Power fuse	250 V 3.15 A Time-lag Fuse	250 V 5 A Time-lag Fuse	
Rush current	25 A max. 5 ms or less/100 V AC 50 A max. 5 ms or less/200 V AC	30 A max. 5 ms or less/100 V AC 60 A max. 5 ms or less/200 V AC	
Power consumption*1	30 W	40 W	45 W
5 V DC internal power supply capacity	900 mA	1100 mA	1100 mA
24 V DC service power supply capacity*2	Supply capacity when 24 V DC service power supply is used for input circuit of the CPU module*3	400 mA (300 mA)	600 mA (300 mA)
	Supply capacity when external power supply is used for input circuit of the CPU module*3	480 mA (380 mA)	740 mA (440 mA)

*1: The values show the state where the service power of 24 V DC is consumed to the maximum level in case that its configuration has the max. no. of connections provided to CPU module. (Including the current in an input circuit)

*2: When I/O modules are connected, they consume current from the 24 V DC service power supply, resulting in decrease of usable current. For details about the service power supply, refer to the manual.

*3: The value in () is capacity of 24 V DC service power supply in the case where operating ambient temperature is lower than 0°C.

● Power supply specifications (FX5U CPU module, DC power supply type)

Item	Specifications		
	FX5U-32M□/D□	FX5U-64M□/D□	FX5U-80M□/D□
Rated voltage	24 V DC		
Voltage fluctuation range	-30%, +20%		
Allowable instantaneous power failure time	Operation can be continued upon occurrence of instantaneous power failure for 5 ms or less.		
Power fuse	250 V 3.15 A Time-lag Fuse	250 V 5 A Time-lag Fuse	
Rush current	50 A max. 0.5 ms or less/24 V DC	65 A max. 2.0 ms or less/24 V DC	
Power consumption*1	30 W	40 W	45 W
5 V DC internal power supply capacity*2	900 mA (775 mA)	1100 mA (975 mA)*2	1100 mA (975 mA)*2
24 V DC internal power supply capacity*2	480 mA (360 mA)	740 mA (530 mA)*2	770 mA (560 mA)*2

*1: The values show the state where power is consumed to the maximum level in case that the configuration has the max. no. of connections provided to CPU module.

*2: The values in the parentheses () indicate the power supply capacity to be resulted when the power supply voltage falls in the range from 16.8 to 19.2 V DC.

● Power supply specifications (FX5UC CPU module)

Item	Specifications		
	FX5UC-32M□/□	FX5UC-64MT/□	FX5UC-96MT/□
Rated voltage	24 V DC		
Voltage fluctuation range	+20%, -15%		
Allowable instantaneous power failure time	Operation can be continued upon occurrence of instantaneous power failure for 5 ms or less.		
Power fuse	125 V 3.15 A Time-lag Fuse		
Rush current	35 A max. 0.5 ms or less/24 V DC	40 A max. 0.5 ms or less/24 V DC	
Power consumption*	5 W/24 V DC (30 W/24 V DC +20%, -15%)	8 W/24 V DC (33 W/24 V DC +20%, -15%)	11 W/24 V DC (36 W/24 V DC +20%, -15%)
5 V DC internal power supply capacity	720 mA		
24 V DC internal power supply capacity	500 mA		

*: The value results when the CPU module is used alone.

The values in the parentheses () result when the maximum no. of connections have been made to the CPU module. (External DC 24 V power supplies of extension modules are not included.)

● Power supply specifications (FX5-4A-ADP)

Item	Specifications
External electric supply (Analog conversion circuit)	24 V DC +20%, -15% 100 mA External electric supply is carried out from the power supply connector of an adapter.
Internal electric supply (Interface)	5 V DC 10 mA Internal electric supply is carried out from 5 V DC power supply of a CPU module.

● Power supply specifications (FX5-4DA-ADP)

Item	Specifications
External power feed (D/A conversion circuit)	24 V DC +20%, -15% 160 mA Power is externally fed from the power supply connector of the adapter.
Internal power feed (interface)	5 V DC 10 mA Power is internally fed from the 5 V DC power supply of the CPU module.

● Power Supply Specifications (FX5-4AD-TC-ADP)

Item	Specifications
Internal power feed (A/D conversion circuit)	24 V DC 20 mA Power is internally fed from 24 V DC power supply of the CPU module.
Internal power feed (interface)	5 V DC 10 mA Power is internally fed from 5 V DC power supply of the CPU module.

● Power supply specifications (FX5-4AD-ADP)

Item	Specifications
Internal power feed (A/D conversion circuit)	24 V DC 20 mA Power is internally fed from the 24 V DC power supply of the CPU module.
Internal power feed (interface)	5 V DC 10 mA Power is internally fed from the 5 V DC power supply of the CPU module.

● Power Supply Specifications (FX5-4AD-PT-ADP)

Item	Specifications
Internal power feed (A/D conversion circuit)	24 V DC 20 mA Power is internally fed from 24 V DC power supply of the CPU module.
Internal power feed (interface)	5 V DC 10 mA Power is internally fed from 5 V DC power supply of the CPU module.

For the general specifications for each model, refer to each manual.

General, Power Supply, Input/Output Specifications

◇ Input specifications

● Input specifications (FX5UJ CPU module)

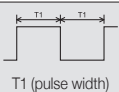
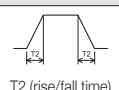
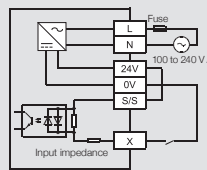
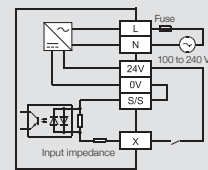
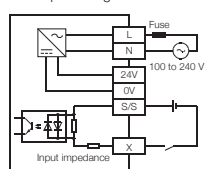
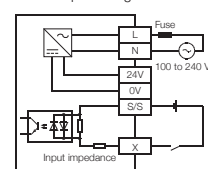
Item	Specifications		
	FX5UJ-24M□	FX5UJ-40M□	FX5UJ-60M□
No. of input points	14 points (16 points)*	24 points	36 points (40 points)*
Connection type	Removable terminal block (M3 screws)		
Input type	Sink/source		
Input signal voltage	24 V DC +20 %, -15%		
Input signal current	X0 to X7	5.3 mA/24 V DC	
	X10 and subsequent	4.0 mA/24 V DC	
Input impedance	X0 to X7	4.3 kΩ	
	X10 and subsequent	5.6 kΩ	
ON input sensitivity current	X0 to X7	3.5 mA or more	
	X10 and subsequent	3.0 mA or more	
OFF input sensitivity current	1.5 mA or less		
Input response frequency	X0, X1, X3, X4	100 kHz When capturing pulses of a response frequency of 50 to 100 kHz, refer to the manual.	
	X2, X5, X6, X7	10 kHz	
Pulse waveform	Waveform		
	X0, X1, X3, X4	5 μs or more	
	X2, X5, X6, X7	50 μs or more	
	Waveform		
Input response time (H/W filter delay)	X0, X1, X3, X4	ON: 5 μs or less OFF: 5 μs or less	
	X2, X5, X6, X7	ON: 30 μs or less OFF: 50 μs or less	
	X10 to X17	ON: 50 μs or less OFF: 150 μs or less	
	X20 and subsequent	ON: Approx. 10 ms OFF: Approx. 10 ms	
Input response time (Digital filter setting value)	X0 to X17	None, 10 μs, 50 μs, 0.1 ms, 0.2 ms, 0.4 ms, 0.6 ms, 1 ms, 5 ms, 10 ms (initial values), 20 ms, 70 ms When using this product in an environment with much noise, set the digital filter.	
Input signal format	No-voltage contact input Sink: NPN open collector transistor Source: PNP open collector transistor		
Input circuit insulation	Photocoupler		
Indication of input operation	LED is lit when input is on		
Input circuit configuration	AC power supply type	- When using 24 V DC service power supply	
		<div style="display: flex; justify-content: space-around;"> <div style="text-align: center;"> <p>Sink input wiring</p>  </div> <div style="text-align: center;"> <p>Source input wiring</p>  </div> </div>	
		- When using external power supply	
		<div style="display: flex; justify-content: space-around;"> <div style="text-align: center;"> <p>Sink input wiring</p>  </div> <div style="text-align: center;"> <p>Source input wiring</p>  </div> </div>	

*: The number in parentheses represents occupied points.

General, Power Supply, Input/Output Specifications

● Input specifications (FX5U CPU module)

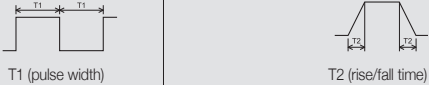
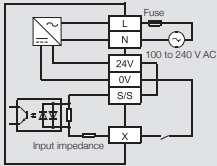
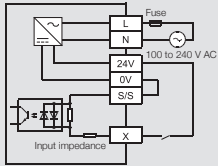
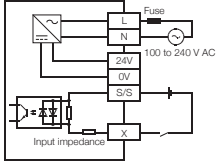
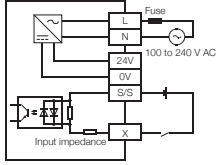
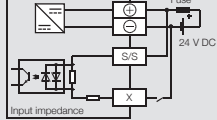
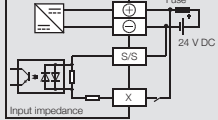
Item	Specifications		
	FX5U-32M□	FX5U-64M□	FX5U-80M□
No. of input points	16 points	32 points	40 points
Connection type	Removable terminal block (M3 screws)		
Input type	Sink/source		
Input signal voltage	24 V DC +20%, -15%		
Input signal current	X0 to X17	5.3 mA/24 V DC	
	X20 and subsequent	4.0 mA/24 V DC	
Input impedance	X0 to X17	4.3 kΩ	
	X20 and subsequent	5.6 kΩ	
ON input sensitive current	X0 to X17	3.5 mA or more	
	X20 and subsequent	3.0 mA or more	
OFF input sensitivity current	1.5 mA or less		
Input response frequency	X0 to X5	200 kHz	—
	X0 to X7	—	200 kHz
	X6 to X17	10 kHz	—
	X10 to X17	—	10 kHz
Pulse waveform	Waveform		
	X0 to X5	T1: 2.5 μs or more, T2: 1.25 μs or less	—
	X0 to X7	—	T1: 2.5 μs or more, T2: 1.25 μs or less
	X6 to X17	T1: 50 μs or more, T2: 25 μs or less	—
	X10 to X17	—	T1: 50 μs or more, T2: 25 μs or less
Input response time (H/W filter delay)	X0 to X5	ON: 2.5 μs or less, OFF: 2.5 μs or less	—
	X0 to X7	—	ON: 2.5 μs or less, OFF: 2.5 μs or less
	X6 to X17	ON: 30 μs or less, OFF: 50 μs or less	—
	X10 to X17	—	ON: 30 μs or less, OFF: 50 μs or less
	X20 and subsequent	—	ON: 50 μs or less, OFF: 150 μs or less
Input response time (Digital filter setting value)	None, 10 μs, 50 μs, 0.1 ms, 0.2 ms, 0.4 ms, 0.6 ms, 1 ms, 5 ms, 10 ms (initial values), 20 ms, 70 ms When using this product in an environment with much noise, set the digital filter.		
Input signal format	No-voltage contact input Sink: NPN open collector transistor Source: PNP open collector transistor		
Input circuit insulation	Photocoupler		
Indication of input operation	LED is lit when input is on		
Input circuit configuration	AC power supply type	- When using 24 V DC service power supply	
		Sink input wiring	Source input wiring
			
		- When using external power supply	
	Sink input wiring	Source input wiring	
			
DC power supply type	Sink input wiring	Source input wiring	
			

General, Power Supply, Input/Output Specifications

● Input specifications (FX5UC CPU module)

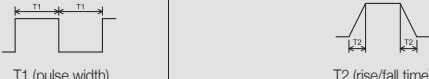
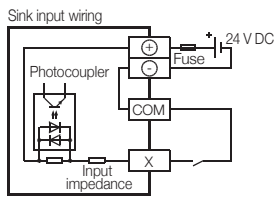
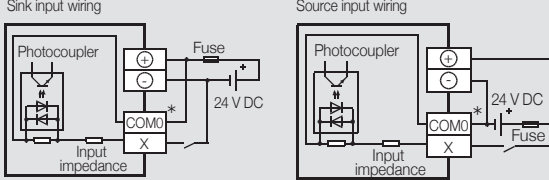
Item	Specifications		
	FX5UC-32M□/□	FX5UC-64MT/□	FX5UC-96MT/□
No. of input points	16 points	32 points	48 points
Connection type	Connector (FX5UC-□MT/D(SS)) Spring clamp terminal block (FX5UC-32M□/□-TS)		
Input type	Sink (FX5UC-□MT/D) Sink/source (FX5UC-□MT/DSS, FX5UC-32MT/DS(S)-TS)		
Input signal voltage	24 V DC +20%, -15%		
Input signal current	X0 to X17	5.3 mA/24 V DC	
	X20 and subsequent	4.0 mA/24 V DC	
Input impedance	X0 to X17	4.3 kΩ	
	X20 and subsequent	5.6 kΩ	
ON input sensitivity current	X0 to X17	3.5 mA or more	
	X20 and subsequent	3.0 mA or more	
OFF input sensitivity current	1.5 mA or less		
Input response frequency	X0 to X5	200 kHz	—
	X0 to X7	—	200 kHz
	X6 to X17	10 kHz	—
	X10 to X17	—	10 kHz
Pulse waveform	Waveform		
	X0 to X5	T1: 2.5 μs or more, T2: 1.25 μs or less	—
	X0 to X7	—	T1: 2.5 μs or more, T2: 1.25 μs or less
	X6 to X17	T1: 50 μs or more, T2: 25 μs or less	—
Input response time (H/W filter delay)	X0 to X5	ON: 2.5 μs or less, OFF: 2.5 μs or less	—
	X0 to X7	—	ON: 2.5 μs or less, OFF: 2.5 μs or less
	X6 to X17	ON: 30 μs or less, OFF: 50 μs or less	—
	X10 to X17	—	ON: 30 μs or less, OFF: 50 μs or less
X20 and subsequent	—	ON: 50 μs or less, OFF: 150 μs or less	
Input response time (Digital filter setting value)	None, 10 μs, 50 μs, 0.1 ms, 0.2 ms, 0.4 ms, 0.6 ms, 1 ms, 5 ms, 10 ms (initial values), 20 ms, 70 ms When using this product in an environment with much noise, set the digital filter.		
Input signal format (Input sensor form)	FX5UC-□MT/D No-voltage contact input NPN open collector transistor FX5UC-□MT/DSS, FX5UC-32M□/□-TS No-voltage contact input Sink: NPN open collector transistor Source: PNP open collector transistor		
Input circuit insulation	Photocoupler		
Indication of input operation	LED is lit when input is on (DISP switch: IN)		
Input circuit configuration	FX5UC-□MT/D		
			
Input circuit configuration	FX5UC-□MT/DSS, FX5UC-32M□/□-TS		
			

*: Spring clamp terminal block type: The [COM0] terminal is the [S/S] terminal.

● Safety inputs specifications (safety main module)

Item		Specifications
		FX5-SF-MU4T5*7
Connection type		Spring clamp terminal block
Number of inputs		4 points
Input voltage (ON)		13 V DC or more (13 V DC to 30 V DC)
Input voltage (OFF)		5 V DC or less (-5 V DC to 5 V DC)
Input current (ON)		3 mA (2.4 mA to 3.8 mA)
Input current (OFF)		2.1 mA or less (-2.5 mA to 2.1 mA)
Input response time (filter delay)		2 ms
Indication of input operation		LED lights when an input is ON.
Minimum switch-off time*1*2 (I0/I1)	Program 1, 2, 4, 5, 6, and 9	24 ms
	Program 3.1, 7, and 8	4 ms
	Program 3.2	76 ms/24 ms
Minimum switch-off time*1*2 (I2/I3)	Program 4, 5, and 6	24 ms
	Program 1, 2, 3, 7, 8, and 9	4 ms
Power-up time		70 ms
Synchronous time monitoring	Program 1 and 2	1500 ms
	Program 4 and 5	500 ms
Muting ON*3	Program 3	61 ms
Muting OFF	Program 3	61 ms (165 ms*4)
Muting gap suppression*5	Program 3	94 ms to 100 ms
Reset time		106 ms
Maximum teach-in time of the ENTER button*6		3 s
Duration of actuation of a reset button (X0 and X1)		50 ms to 5 s
Number of occupied input/output points		8 points (Either input or output is available for counting.)

*1: The minimum switch-off time is the minimum time takes until a switch-off condition is detected after a module is switched off.

*2: A response time without any sensors. When sensors are connected, the data of the connected sensors is applied and the minimum switch-off time is extended.

*3: The time from when a muting condition is enabled (I2/I3 are turned ON) until a muting function is activated.

*4: Indicates the maximum switch-off time when a muting error occurs.

*5: A muting input (I2 or I3) keeps OFF for the specified period of time.

*6: A time from when an ERROR LED starts flashing.

*7: For details regarding the general inputs, refer to the manual.

● Safety inputs specifications (safety input expansion module)

Item		Specifications
		FX5-SF-8DI4
Connection type		Spring clamp terminal block
Number of inputs		8 points
Input voltage (ON)		13 V DC or more (13 V DC to 30 V DC)
Input voltage (OFF)		5 V DC or less (-5 V DC to 5 V DC)
Input current (ON)		3 mA (2.4 mA to 3.8 mA)
Input current (OFF)		2.1 mA or less (-2.5 mA to 2.1 mA)
Indication of input operation		LED lights when an input is ON.
Minimum switch-off time	Program 1, 2, 3, 4, 5, and 8	24 ms
	Program 6 and 7	4 ms
Synchronous time monitoring	Program 3 and 5	1500 ms
Power-up time		70 ms
Number of occupied input/output points		0 points (no occupied points)

General, Power Supply, Input/Output Specifications

● Input specifications (Extension module (extension connector type), input, input/output module)

Item	Specifications						
	FX5-C16EX/D	FX5-C32EX/D	FX5-C32ET/D	FX5-C16EX/DS	FX5-C32EX/DS	FX5-C32ET/DSS	FX5-C32EX/DS-TS, FX5-C32ET/DS(S)-TS
Connection type	Connector						Spring clamp terminal block
Input type	Sink			Sink/source			
Input signal voltage	24 V DC +20%, -15%						
Input signal current	4.0 mA/24 V DC						
Input impedance	5.6 kΩ						
Input sensitivity current	ON: 3.0 mA or more						
	OFF: 1.5 mA or less						
Input response time	ON: 50 μs or less OFF: 150 μs or less						
Input signal format	No-voltage contact input Sink: NPN open collector transistor			No-voltage contact input Sink: NPN open collector transistor Source: PNP open collector transistor			
Input circuit insulation	Photocoupler						
Indication of input operation	LED is lit when input is on		LED is lit when input is on (F/L of DISP switch is used to change between lower and higher numbers.)		LED is lit when input is on (DISP switch: IN)		LED is lit when input is on
	LED is lit when input is on		LED is lit when input is on (F/L of DISP switch is used to change between lower and higher numbers.)		LED is lit when input is on (DISP switch: IN)		LED is lit when input is on
Input circuit configuration							

● Input specifications (Extension module (extension cable type), input, input/output module)

Item	Specifications					
	FX5-8EX/ES	FX5-16EX/ES	FX5-16ER/ES	FX5-16ET/ES	FX5-16ET/ESS	FX5-16ET/ES-H FX5-16ET/ESS-H
Connection type	Screw terminal block					
Input type	Sink/source					
Input signal voltage	24 V DC +20%, -15%					
Input signal current	4.0 mA/24 V DC				5.3 mA/24 V DC	
Input impedance	5.6 kΩ				4.3 kΩ	
Input sensitivity current	ON: 3.0 mA or more				3.5 mA or more	
	OFF: 1.5 mA or less					
Input response time	ON: 50 μs or less OFF: 150 μs or less				X0 to 5 ON: 2.5 μs or less OFF: 2.5 μs or less X6, 7 ON: 30 μs or less OFF: 50 μs or less	
Input signal format	No-voltage contact input Sink: NPN open collector transistor Source: PNP open collector transistor					
Input circuit insulation	Photocoupler					
Indication of input operation	LED is lit when input is on					
Input circuit configuration	<p>When using 24 V DC service power supply</p>			<p>When using external power supply</p>		
	<p>Source input wiring</p>			<p>Source input wiring</p>		

For the general specifications for each model, refer to each manual.

● Input specifications (Extension module powered input/output module)

Item	Specifications					
	FX5-32ER/ES	FX5-32ET/ES	FX5-32ET/ESS	FX5-32ER/DS	FX5-32ET/DS	FX5-32ET/DSS
Connection type	Screw terminal block					
Input type	Sink/source					
Input signal voltage	24 V DC +20%, -15%					
Input signal current	4.0 mA/24 V DC					
Input impedance	5.6 kΩ					
Input sensitivity current	ON	3.0 mA or more				
	OFF	1.5 mA or less				
Input response time	ON: 50 μs or less OFF: 150 μs or less					
Input signal format	No-voltage contact input Sink: NPN open collector transistor Source: PNP open collector transistor					
Input circuit insulation	Photocoupler					
Indication of input operation	LED is lit when input is on					
Input circuit configuration	<p>When using 24 V DC service power supply</p> <p>When using external power supply</p>					

◇ Output specifications

● Relay output (FX5UJ CPU module)

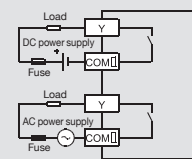
Item	Specifications		
	FX5UJ-24MR/ES	FX5UJ-40MR/ES	FX5UJ-60MR/ES
No. of output points	10 points (16 points)*	16 points	24 points
Connection type	Removable terminal block (M3 screws)		
Output type	Relay		
External power supply	30 V DC or less 240 V AC or less (*250 V AC or less* if not a CE, UL, cUL compliant item)		
Max. load	2 A/point The total load current per common terminal should be the following value. • 3 output points/common terminal: 6 A or less • 4 output points/common terminal: 8 A or less		
Min. load	5 V DC, 2 mA (reference values)		
Open circuit leakage current	—		
Response time	OFF—ON	Approx. 10 ms	
	ON—OFF	Approx. 10 ms	
Circuit insulation	Mechanical insulation		
Indication of output operation	LED is lit when output is on		
Output circuit configuration	 <p>A number is entered in the □ of [COM□].</p>		

*: The number in parentheses represents occupied points.

General, Power Supply, Input/Output Specifications

● Relay output (FX5U CPU module)

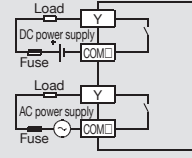
Item	Specifications		
	FX5U-32MR/□	FX5U-64MR/□	FX5U-80MR/□
No. of output points	16 points	32 points	40 points
Connection type	Removable terminal block (M3 screws)		
Output type	Relay		
External power supply	30 V DC or less 240 V AC or less ("250 V AC or less" if not a CE, UL, cUL compliant item)		
Max. load	2 A/point The total load current per common terminal should be the following value. • 4 output points/common terminal: 8 A or less • 8 output points/common terminal: 8 A or less		
Min. load	5 V DC, 2 mA (reference values)		
Open circuit leakage current	—		
Response time	OFF→ON	Approx. 10 ms	
	ON→OFF	Approx. 10 ms	
Circuit insulation	Mechanical insulation		
Indication of output operation	LED is lit when output is on		
Output circuit configuration	 <p>A number is entered in the □ of [COM□].</p>		

● Relay output (FX5UC CPU module)

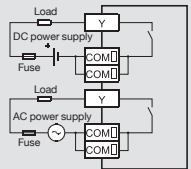
Items	Specifications	
	FX5UC-32MR/DS-TS	
No. of output points	16 points	
Connection type	Spring clamp terminal block	
Output type	Relay	
External power supply	30 V DC or less 240 V AC or less ("250 V AC or less" if not a CE, UL, cUL compliant item)	
Max. load	2 A/point The total load current per common terminal should be the following value. • 8 output points/common terminal: 4 A* or less	
Min. load	5 V DC, 2 mA (reference values)	
Open circuit leakage current	—	
Response time	OFF→ON	Approx. 10 ms
	ON→OFF	Approx. 10 ms
Circuit insulation	Mechanical insulation	
Indication of output operation	LED is lit when output is on	
Output circuit configuration	 <p>A number is entered in the □ of [COM□].</p>	

*: 8 A or less when two common terminals are connected to the external part.

● Transistor output (FX5UJ CPU module)

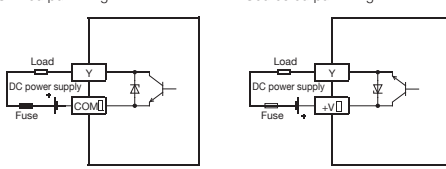
Item	Specifications		
	FX5UJ-24MT/□	FX5UJ-40MT/□	FX5UJ-60MT/□
No. of output points	10 points (16 points)*	16 points	24 points
Connection type	Removable terminal block (M3 screws)		
Output type	Transistor/sink output (FX5UJ-□MT/ES) Transistor/source output (FX5UJ-□MT/ESS)		
External power supply	5-30 V DC		
Max. load	0.5 A/point The total load current per common terminal should be the following value. • 3 output points/common terminal: 0.6 A or less • 4 output points/common terminal: 0.8 A or less		
Open circuit leakage current	0.1 mA or less/30 V DC		
Voltage drop when ON	Y0 to Y2	1.0 V or less	
	Y3 and subsequent	1.5 V or less	
Response time	Y0 to Y2	2.5 μs or less/10 mA or more (5-24 V DC)	
	Y3 and subsequent	0.2 ms or less/200 mA or more (24 V DC)	
Circuit insulation	Photocoupler		
Indication of output operation	LED is lit when output is on		
Output circuit configuration	 <p>A number is entered in the □ of [COM□]. A number is entered in the □ of [+V□].</p>		

*: The number in parentheses represents occupied points.

● Transistor output (FX5U CPU module)

Item	Specifications		
	FX5U-32MT/□	FX5U-64MT/□	FX5U-80MT/□
No. of output points	16 points	32 points	40 points
Connection type	Screw terminal block		
Output type	Transistor/sink output (FX5U-□MT/ES, FX5U-□MT/DS) Transistor/source output (FX5U-□MT/ESS, FX5U-□MT/DSS)		
External power supply	5-30 V DC		
Max. load	0.5 A/point The total load current per common terminal should be the following value. <ul style="list-style-type: none"> • 4 output points/common terminal: 0.8 A or less • 8 output points/common terminal: 1.6 A or less 		
Open circuit leakage current	0.1 mA or less/30 V DC		
Voltage drop when ON	Y0 to Y3	1.0 V or less	
	Y4 and subsequent	1.5 V or less	
Response time	Y0 to Y3	2.5 μs or less/10 mA or more (5-24 V DC)	
	Y4 and subsequent	0.2 ms or less/200 mA or more (24 V DC)	
Circuit insulation	Photocoupler		
Indication of output operation	LED is lit when output is on		
Output circuit configuration	Sink output wiring		Source output wiring
A number is entered in the □ of [COM□]. A number is entered in the □ of [+V□].			

● Transistor output (FX5UC CPU module)

Item	Specifications		
	FX5UC-32MT/□	FX5UC-64MT/□	FX5UC-96MT/□
No. of output points	16 points	32 points	48 points
Connection type	Connector (FX5UC-□MT/D(SS)) Spring clamp terminal block (FX5UC-32MT/DS(S)-TS)		
Output type	Transistor/sink output (FX5UC-□MT/D(S)-TS) Transistor/source output (FX5UC-□MT/DSS(+)-TS)		
External power supply	5-30 V DC		
Max. load	Y0 to Y3: 0.3 A/1 point Y4 and subsequent: 0.1 A/1 point The total load current per common terminal should be the following value. <ul style="list-style-type: none"> • 8 output points/common terminal: 0.8 A or less* 		
Open circuit leakage current	0.1 mA or less/30 V DC		
Voltage drop when ON	Y0 to Y3	1.0 V or less	
	Y4 and subsequent	1.5 V or less	
Response time	Y0 to Y3	2.5 μs or less/10 mA or more (5-24 V DC)	
	Y4 and subsequent	0.2 ms or less/100 mA (24 V DC)	
Circuit insulation	Photocoupler		
Indication of output operation	LED is lit when output is on (DISP switch: OUT) (FX5UC-□MT/D(SS)) LED is lit when output is on (FX5UC-32MT/DS(S)-TS)		
Output circuit configuration	Sink output wiring		Source output wiring
A number is entered in the □ of [COM□]. A number is entered in the □ of [+V□].			

*: 1.6 A or less when two common terminals are connected outside.

General, Power Supply, Input/Output Specifications

● Safety outputs specifications (safety main module)

Item		Specifications
		FX5-SF-MU4T5*3
Connection type		Spring clamp terminal block
Number of outputs		4 points
Output method		Source output, short-circuit protection, cross-circuit detection*1
Output voltage		18.4 V DC to 30.0 V DC
Output current		2.0 A (@TA≤45°C) 1.5 A (@TA≤55°C)
Total current I _{sum}		4.0 A (@TA≤45°C) 3.0 A (@TA≤55°C)
Leak current (in the switch OFF status)		1 mA or less
Indication of output operation		LED lights when an output is ON.
Response time*2 (I0/I1)	Program 1, 2, 4, 5, 6, and 9	29 ms
	Program 3.1, 7, and 8	9 ms
	Program 3.2	81 ms/29 ms
Response time*2 (I2/I3)	Program 4, 5, and 6	29 ms
	Program 1, 2, 3, 7, 8, and 9	9 ms
Response time (XS0)		9 ms
Off delay time		0 / 0.5 / 1 / 1.5 / 2 / 2.5 / 3 / 3.5 / 4 / 5 s
Number of occupied input/output points		8 points (Either input or output is available for counting.)

*1: A cross-circuit detection is performed only in the module.

*2: A response time without any sensors. When sensors are connected, the data of the connected sensors is applied and the minimum switch-off time is extended.

*3: For details regarding the test outputs, refer to the manual.

General, Power Supply, Input/Output Specifications

● Transistor output (sink output, extension module)

Item	Specifications										
	FX5-C16EYT/D	FX5-C32EYT/D	FX5-C32ET/D	FX5-C32EYT/D-TS	FX5-C32ET/DS-TS	FX5-8EYT/ES	FX5-16EYT/ES	FX5-16ET/ES	FX5-32ET/ES	FX5-32ET/DS	FX5-16ET/ES-H
Connection type	Connector			Spring clamp terminal block			Screw terminal block				
Output type	Transistor output/sink output										
External power supply	5 to 30 V DC										
Max. load	0.1 A/1 point The total load current per common terminal should be the following value. • 8 output points/common terminal: 0.8 A or less					0.5 A/1 point The total load current per common terminal should be the following value. • 4 output points/common terminal: 0.8 A or less • 8 output points/common terminal: 1.6 A or less					
Open circuit leakage current	0.1 mA/30 V DC										
Voltage drop when ON	1.5 V or less										
Response time	OFF→ON	0.2 ms or less/100 mA (at 24 V DC)				0.2 ms or less/200 mA (at 24 V DC)					Y0, Y1, Y4, Y5: 2.5 μs or less/10 mA (at 5 to 24 V DC) Y2, Y3, Y6, Y7: 0.2 ms or less/200 mA (at 24 V DC)
	ON→OFF	0.2 ms or less/100 mA (at 24 V DC)				0.2 ms or less/200 mA (at 24 V DC)					Y0, Y1, Y4, Y5: 2.5 μs or less/10 mA (at 5 to 24 V DC) Y2, Y3, Y6, Y7: 0.2 ms or less/200 mA (at 24 V DC)
Circuit insulation	Photocoupler										
Indication of output operation	LED is lit when output is on	LED is lit when output is on (F/L of DISP switch is used to change between lower and higher numbers.)	LED is lit when output is on (DISP switch: OUT)	LED is lit when output is on			LED is lit when output is on				
Output circuit configuration											

General, Power Supply, Input/Output Specifications

● Transistor output (source output, extension module)

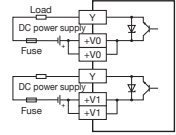
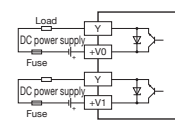
Item	Specifications											
	FX5-C16EYT/ DSS	FX5-C32EYT/ DSS	FX5-C32ET/ DSS	FX5-C32EYT/ DSS-TS	FX5-C32ET/ DSS-TS	FX5-8EYT/ ESS	FX5-16EYT/ ESS	FX5-16ET/ ESS	FX5-32ET/ ESS	FX5-32ET/ DSS	FX5-16ET/ ESS-H	
Connection type	Connector			Spring clamp terminal block		Screw terminal block						
Output type	Transistor output/sink output											
External power supply	5 to 30 V DC											
Max. load	0.1 A/1 point The total load current per common terminal should be the following value. • 8 output points/common terminal: 0.8 A or less					0.5 A/1 point The total load current per common terminal should be the following value. • 4 output points/common terminal: 0.8 A or less • 8 output points/common terminal: 1.6 A or less						
Open circuit leakage current	0.1 mA/30 V DC											
Voltage drop when ON	1.5 V or less											
Response time	OFF→ON	0.2 ms or less/100 mA (at 24 V DC)				0.2 ms or less/200 mA (at 24 V DC)					Y0, Y1, Y4, Y5: 2.5 μs or less/10 mA (at 5 to 24 V DC) Y2, Y3, Y6, Y7: 0.2 ms or less/ 200 mA (at 24 V DC)	
	ON→OFF	0.2 ms or less/100 mA (at 24 V DC)				0.2 ms or less/200 mA (at 24 V DC)					Y0, Y1, Y4, Y5: 2.5 μs or less/10 mA (at 5 to 24 V DC) Y2, Y3, Y6, Y7: 0.2 ms or less/ 200 mA (at 24 V DC)	
Circuit insulation	Photocoupler											
Indication of output operation	LED is lit when output is on	LED is lit when output is on (F/L of DISP switch is used to change between lower and higher numbers.)	LED is lit when output is on (DISP switch: OUT)	LED is lit when output is on			LED is lit when output is on					
Output circuit configuration												

● Relay output (extension module)

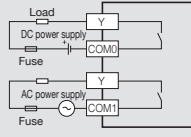
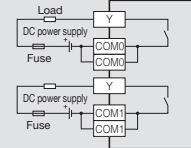
Item	Specifications					
	FX5-8EYR/ES	FX5-16EYR/ES	FX5-16ER/ES	FX5-32ER/ES	FX5-32ER/DS	FX5-C16EYR/D-TS
Connection type	Screw terminal block				Spring clamp terminal block	
Output type	Relay					
External power supply	30 V DC or less 240 V AC or less (*250 V AC or less* if not a CE, UL, cUL compliant item)					
Max. load	2 A/1 point The total load current per common terminal should be the following value. • 4 output points/common terminal: 8 A or less • 8 output points/common terminal: 8 A or less				2 A/1 point The total load current per common terminal should be the following value. • 8 output points/common terminal: 4 A or less*	
Min. load	5 V DC, 2 mA (reference values)					
Response time	OFF→ON	Approx. 10 ms				
	ON→OFF	Approx. 10 ms				
Circuit insulation	Mechanical insulation					
Indication of output operation	LED is lit when output is on					
Output circuit configuration						

*: When two common terminals are connected outside the CPU module, resistance load is 8 A or less.

General, Power Supply, Input/Output Specifications

● Built-in analog input

Item		Specifications	
		FX5U CPU module	
Analog input points		2 points (2 channels)	
Analog input	Voltage	0 to 10 V DC (input resistance 115.7 kΩ)	
Digital output		Unsigned 12-bit binary	
Device allocation		SD6020 (ch1 A/D converted input data) SD6060 (ch2 A/D converted input data)	
Input characteristics, maximum resolution	Digital output value	0 to 4000	
	Maximum resolution	2.5 mV	
Precision (Accuracy in respect to full-scale digital output value)	Ambient temperature 25±5°C	Within ±0.5% (±20 digit*2)	
	Ambient temperature 0 to 55°C	Within ±1.0% (±40 digit*2)	
	Ambient temperature -20 to 0°C*1	Within ±1.5% (±60 digit*2)	
Conversion speed		30 μs/channels (data refreshed every operation cycle)	
Absolute maximum input		-0.5 V, +15 V	
Isolation method		Non-isolation from the CPU module internal circuit, Non-isolation between the input terminals (channels)	
Number of occupied input/output points		0 points (does not pertain to the max. No. of input/output points of the CPU module.)	
Terminal block used		European-type terminal block	

*1: Products manufactured earlier than June 2016 do not support this specification.

*2: The term "digit" refers to "digital value".

● Built-in analog output

Item		Specifications	
		FX5U CPU module	
Analog output points		1 point (1 channel)	
Digital input		Unsigned 12-bit binary	
Analog output	Voltage	0 to 10 V DC (external load resistance 2 kΩ to 1 MΩ)	
Device allocation		SD6180 (Output setting data)	
Output characteristics, maximum resolution*1	Digital input value	0 to 4000	
	Maximum resolution	2.5 mV	
Accuracy*2 (Accuracy in respect to full-scale analog output value)	Ambient temperature 25±5°C	Within ±0.5% (±20 digit*4)	
	Ambient temperature 0 to 55°C	Within ±1.0% (±40 digit*4)	
	Ambient temperature -20 to 0°C*3	Within ±1.5% (±60 digit*4)	
Conversion speed		30 μs (data refreshed every operation cycle)	
Isolation method		Non-isolation from the CPU module internal circuit	
Number of occupied input/output points		0 points (does not pertain to the max. No. of input/output points of the CPU module.)	
Terminal block used		European-type terminal block	

*1: There is a dead band near 0 V output, which is an area where some analog output values do not reflect digital input values.

*2: External load resistance is set to 2 kΩ when shipped from the factory. Thus, output voltage will increase somewhat if the resistance is set higher than 2 kΩ. When the resistance is 1 MΩ, output voltage increases maximum 2%.

*3: Products manufactured earlier than June 2016 do not support this specification.

*4: The term "digit" refers to "digital value".

● Built-in RS-485 communication

Item	Specifications	
	FX5U/FX5UC CPU module	
Transmission standards	Conforms to RS-485/RS-422 specifications	
Data transmission speed	Max. 115.2 kbps	
Communication method	Full-duplex (FDX) / Half-duplex (HDX)	
Maximum transmission distance	50 m	
Protocol type	MELSOFT connection, MC protocol (1C/3C/4C frames), non-protocol communication, MODBUS RTU communication, inverter communication, N:N network, parallel link, communication protocol support	
Circuit insulation	Non-isolation	
Terminal resistors	Built-in (OPEN/110 Ω/330 Ω)	
Terminal block used	European-type terminal block	

General, Power Supply, Input/Output Specifications

● Built-in Ethernet communication

Item	Specifications	
	FX5UU/FX5U/FX5UC CPU module	
Data transmission speed	100/10 Mbps	
Communication method	Full-duplex (FDX) / Half-duplex (HD _X)*1	
Interface	RJ45 connector	
Transmission method	Base band	
Maximum segment length	100 m (The distance between hub and node)*2	
Cascade connection	100BASE-TX	Max. 2 stages*3
	10BASE-T	Max. 4 stages*3
Protocol type	CC-Link IE Field Network Basic, MELSOFT connection, SLMP server (3E/1E*9) frame, socket communication, communication protocol support, FTP server, FTP client*9, MODBUS/TCP communication, SNT _P client, Web server (HTTP), simple CPU communication function	
Number of connections	Total 8 connections*4 *5 (Up to 8 external devices can access one CPU module at the same time.)	
Hub*1	Hubs with 100BASE-TX or 10BASE-T ports*6 are available.	
IP address*7	Initial value: 192.168.3.250	
Circuit insulation	Pulse transformer insulation	
Cable used*8	For 100BASE-TX connection	Ethernet cable of category 5 or higher (STP cable)
	For 10BASE-T connection	Ethernet cable of category 3 or higher (STP cable)

*1: IEEE802.3x flow control is not supported.

*2: For maximum segment length (length between hubs), consult the manufacturer of the hub used.

*3: Number of stages that can be connected when a repeater hub is used. When a switching hub is used, check the specifications of the switching hub used.

*4: One device connected to MELSOFT is not included in the number of connections. (The second and subsequent devices are included.)

*5: The CC-Link IE Field Network Basic, FTP server, FTP client, SNT_P client, Web server and simple CPU communication function are not included in the number of connections.

*6: The ports must comply with the IEEE802.3 100BASE-TX or IEEE802.3 10BASE-T standards.

*7: If the 1st octet is 0 or 127, a parameter error (2222H) will result. (Example: 0.0.0.0, 127.0.0.0 etc.)

*8: A straight cable can be used. If a personal computer or GOT and CPU module are directly connected a cross cable can be used.

*9: Supported only by the FX5U/FX5UC CPU module.

● Built-in USB communication

Item	Specifications	
	FX5UU CPU module	
Data transmission speed	Full Speed (Max. 12 Mbps)	
Interface	Mini-B	

● Built-in positioning function

Item	Specifications	
	FX5UU CPU module	FX5U/FX5UC CPU module
Number of control axes	3 axes	4 axes* (Simple linear interpolation by 2-axis simultaneous start)
Maximum frequency	2147483647 (200 kpps in pulses)	
Positioning program	Sequence program, Table operation	
Pulse output instruction	PLSY and DPLSY instructions	
Positioning instruction	DSZR, DDSZR, DVIT, DDVIT, TBL, DRVTBL, DRVMUL, DABS, PLSV, DPLSV, DRVI, DDRVI, DRVA, and DDRVA instructions	

*: The number of control axes is 2 when the pulse output mode is CW/CCW mode.

● Built-in high-speed counter function

Item	Specifications		
	Input specifications	Frequency	
		FX5UU CPU module	FX5U/FX5UC CPU module
Types of high-speed counters	1-phase, 1-input counter (S/W)	100 kHz*1	200 kHz
	1-phase, 1-input counter (H/W)	100 kHz*1	200 kHz
	1-phase, 2-input counter	100 kHz	200 kHz
	2-phase, 2-input counter [1 edge count]	100 kHz	200 kHz
	2-phase, 2-input counter [2 edge count]	50 kHz	100 kHz
Input allocation	2-phase, 2-input counter [4 edge count]	25 kHz	50 kHz
	Parameter setup*2		
High-speed counter instruction	[High-speed processing instruction] - Setting 32-bit data comparison (DHSCS) - Resetting 32-bit data comparison (DHSCR) - Comparison of 32-bit data band (DHSZ) - Start/stop of the 16-bit data high-speed I/O function (HIOEN) - Start/stop of the 32-bit data high-speed I/O function (DHIEN)		
	[High-speed transfer instruction of current value] - High-speed current value transfer of 16-bit data (HCMOV) - High-speed current value transfer of 32-bit data (DHCMOV)		

*1: 1-phase, 1-input 100 kHz: 4 ch, 10 kHz: 4 ch

*2: For details, refer to the manual.

◇ Extension device specifications I/O modules

● Powered input/output modules

Model	Total No. of points	No. of input/output points, Input/output type			Connection type	
		Input		Output		
FX5-32ER/ES	32 points	16 points	24 V DC (Sink/source)	16 points	Relay	Screw terminal block
FX5-32ET/ES				Transistor (Sink)		
FX5-32ET/ESS				Transistor (Source)		
FX5-32ER/DS				Relay		
FX5-32ET/DS				Transistor (Sink)		
FX5-32ET/DSS				Transistor (Source)		

● Input module

Model	Total No. of points	No. of input/output points, Input/output type			Connection type
		Input		Output	
FX5-8EX/ES	8 points	8 points	24 V DC (Sink/source)	—	Screw terminal block
FX5-16EX/ES	16 points	16 points	24 V DC (Sink)	—	Connector
FX5-C16EX/D			24 V DC (Sink/source)		
FX5-C32EX/D	32 points	32 points	24 V DC (Sink)	—	Spring clamp terminal block
FX5-C32EX/DS			24 V DC (Sink/source)		
FX5-C32EX/DS-TS					

● Output module

Model	Total No. of points	No. of input/output points, Input/output type			Connection type	
		Input		Output		
FX5-8EYR/ES	8 points	—	—	8 points	Relay	Screw terminal block
FX5-8EYT/ES				Transistor (Sink)		
FX5-8EYT/ESS				Transistor (Source)		
FX5-16EYR/ES	16 points	—	—	16 points	Relay	Connector
FX5-16EYT/ES					Transistor (Sink)	
FX5-16EYT/ESS					Transistor (Source)	
FX5-C16EYT/D					Transistor (Sink)	
FX5-C16EYT/DSS	32 points	—	—	32 points	Transistor (Source)	Spring clamp terminal block
FX5-C16EYR/D-TS					Relay	Connector
FX5-C32EYT/D					Transistor (Sink)	Spring clamp terminal block
FX5-C32EYT/D-TS					Transistor (Sink)	Spring clamp terminal block
FX5-C32EYT/DSS					Transistor (Source)	Connector
FX5-C32EYT/DSS-TS	Transistor (Source)	Spring clamp terminal block				

● I/O module

Model	Total No. of points	No. of input/output points, Input/output type			Connection type	
		Input		Output		
FX5-16ER/ES	16 points	8 points	24 V DC (Sink/source)	8 points	Relay	Screw terminal block
FX5-16ET/ES				Transistor (Sink)		
FX5-16ET/ESS				Transistor (Source)		
FX5-C32ET/D	32 points	16 points	24 V DC (Sink)	16 points	Transistor (Sink)	Connector
FX5-C32ET/DS-TS			24 V DC (Sink/source)		Transistor (Sink)	Spring clamp terminal block
FX5-C32ET/DSS					Transistor (Source)	Connector
FX5-C32ET/DSS-TS					Transistor (Source)	Spring clamp terminal block

● High-speed pulse input/output module

Model	Total No. of points	No. of input/output points, Input/output type			Connection type	
		Input		Output		
FX5-16ET/ES-H*	16 points	8 points	24 V DC (Sink/source)	8 points	Transistor (Sink)	Screw terminal block
FX5-16ET/ESS-H*				Transistor (Source)		

*: Supported by FX5U/FX5UC CPU module Ver. 1.030 or later.

General, Power Supply, Input/Output Specifications

◇ Expansion adapter

● FX5-232ADP

Item	Specifications
Transmission standard/ Maximum transmission distance/insulation	Conforming to RS-232C/15 m/Photocoupler (Between communication line and CPU module)
External device connection method	9-pin D-sub, male
Communication method	Half-duplex bidirectional/Full-duplex bidirectional
Protocol type	MELSOFT connection, MC protocol (1C/3C/4C frame), non-protocol communication, MODBUS RTU communication, predefined protocol support
Baud rate	300/600/1200/2400/4800/9600/19200/38400/57600/115200 (bps)*1
Compatible CPU module	FX5UJ, FX5U, FX5UC
Number of occupied input/output points	0 points (no occupied points)
Control power (supplied from CPU module)	5 V DC, 30 mA /24 V DC, 30 mA*2

*1: The communication method and baud rate vary depending on the type of communication.

*2: Current consumption calculation is not required for the FX5UJ CPU module.

● FX5-485ADP

Item	Specifications
Transmission standard/ Maximum transmission distance/insulation	Conforming to RS-485, RS-422/1200 m/Photocoupler (Between communication line and CPU module)
External device connection method	European-type terminal block
Communication method	Half-duplex bidirectional/Full-duplex bidirectional
Protocol type	MELSOFT connection, MC protocol (1C/3C/4C frame), non-protocol communication, MODBUS RTU communication, inverter communication, N:N network, parallel link, predefined protocol support
Baud rate	300/600/1200/2400/4800/9600/19200/38400/57600/115200 (bps)*1
Terminal resistors	Built-in (OPEN/110 Ω/330 Ω)
Compatible CPU module	FX5UJ, FX5U, FX5UC
Number of occupied input/output points	0 points (no occupied points)
Control power (supplied from CPU module)	5 V DC, 20 mA /24 V DC, 30 mA*2

*1: The communication method and baud rate vary depending on the type of communication.

*2: Current consumption calculation is not required for the FX5UJ CPU module.

● FX5-4A-ADP

Item	Specifications				
Analog input	Analog input points	2 points (2 channels)			
	Analog input voltage	-10 to +10 V DC (input resistance 1 MΩ)			
	Analog input current	-20 to +20 mA DC (input resistance 250 Ω)			
	Digital output value	14-bit binary value			
	Input characteristics, resolution*1	Analog input range			
		Voltage	0 to 10 V	0 to 16000	625 μV
			0 to 5 V	0 to 16000	312.5 μV
			1 to 5 V	0 to 12800	312.5 μV
			-10 to +10 V	-8000 to +8000	1250 μV
		Current	0 to 20 mA	0 to 16000	1.25 μA
4 to 20 mA	0 to 12800		1.25 μA		
Accuracy (Accuracy in respect to full-scale digital output value)	Ambient temperature 25±5°C: within ±0.1% (±16 digits)				
	Ambient temperature 0 to 55°C: within ±0.2% (±32 digits)				
Analog output	Analog output points	2 points (2 channels)			
	Digital input	14-bit binary value			
	Analog output voltage	-10 to +10 V DC (external load resistance value 1 kΩ to 1 MΩ)			
	Analog output current	0 to 20 mA DC (external load resistance value 0 to 500 Ω)			
	Output characteristics, resolution*1	Analog output range			
		Voltage	0 to 10 V	0 to 16000	625 μV
			0 to 5 V	0 to 16000	312.5 μV
			1 to 5 V	0 to 16000	250 μV
			-10 to +10 V	-8000 to +8000	1250 μV
		Current	0 to 20 mA	0 to 16000	1.25 μA
4 to 20 mA	0 to 16000		1 μA		
Accuracy (Accuracy in respect to full-scale analog output value)	Ambient temperature 25±5°C: ±0.1 % (Voltage ±20 mV, Current ±20 μA)				
	Ambient temperature 0 to 55°C: ±0.2 % (Voltage ±40 mV, Current ±40 μA)				
Absolute maximum input	Voltage: ±15 V, Current: ±30 mA				
Conversion speed	Maximum 2.0 ms (The data will be updated at every scan time of the PLC.)				
Isolation method	Between input terminal and PLC: Photocoupler Between input channels: Non-isolation				
Power supply	24 V DC +20%, -15% 100 mA (external power supply)*2 5 V DC, 10 mA (internal power supply)*2				
Compatible CPU module	FX5UJ: Ver. 1.010 or later FX5U, FX5UC: Ver. 1.240 or later				
Number of occupied input/output points	0 points (no occupied points)				

*1: For details on the input conversion and output conversion characteristics, refer to the manual.

*2: Current consumption calculation is not required for the FX5UJ CPU module.

General, Power Supply, Input/Output Specifications

● FX5-4AD-ADP

Item	Specifications			
Analog input points	4 points (4 channels)			
External device connection method	European-type terminal block			
Analog input voltage	-10 to +10 V DC (input resistance 1 MΩ)			
Analog input current	-20 to +20 mA DC (input resistance 250 Ω)			
Digital output value	14-bit binary value			
Input characteristics, resolution*1	Analog input range			
	Voltage	0 to 10 V	0 to 16000	625 μV
		0 to 5 V	0 to 16000	312.5 μV
		1 to 5 V	0 to 12800	312.5 μV
	Current	-10 to +10 V	-8000 to +8000	1250 μV
		0 to 20 mA	0 to 16000	1.25 μA
4 to 20 mA		0 to 12800	1.25 μA	
Accuracy (Accuracy in respect to full-scale digital output value)	Ambient temperature 25±5°C: within ±0.1% (±16 digit) Ambient temperature 0 to 55°C: within ±0.2% (±32 digit) Ambient temperature -20 to 0°C*: within ±0.3% (±48 digit)			
Absolute maximum input	Voltage: ±15 V, Current: ±30 mA			
Conversion speed	Maximum 450 μs (The data will be updated at every scan time of the PLC.)			
Isolation method	Between input terminal and PLC: Photocoupler Between input terminal channels: Non-isolation			
Power supply	24 V DC, 20 mA (internal power supply)*3 5 V DC, 10 mA (internal power supply)*3			
Compatible CPU module	FX5UJ, FX5U, FX5UC			
Number of occupied input/output points	0 points (no occupied points)			

- *1: For the input conversion characteristic, refer to manuals of each product.
*2: Products manufactured earlier than June 2016 do not support this specification.
*3: Current consumption calculation is not required for the FX5UJ CPU module.

● FX5-4AD-TC-ADP

Item	Specifications		
Analog input points	4 points (4 channels)		
External device connection method	European-type terminal block		
Usable thermocouple	K, J, T, B, R, S		
Temperature measuring range	K	-200 to 1200°C (-328 to 2192°F)	
	J	-40 to 750°C (-40 to 1382°F)	
	T	-200 to 350°C (-328 to 662°F)	
	B	600 to 1700°C (1112 to 3092°F)	
	R	0 to 1600°C (32 to 2912°F)	
	S	0 to 1600°C (32 to 2912°F)	
Digital output value	16-bit signed binary value		
	K	-2000 to 12000 (-3280 to 21920)	
	J	-400 to 7500 (-400 to 13820)	
	T	-2000 to 3500 (-3280 to 6620)	
	B	6000 to 17000 (11120 to 30920)	
	R, S	0 to 16000 (320 to 29120)	
Accuracy*1	Ambient temperature 25±5°C	K	±3.7°C (-100 to 1200°C)*2 ±4.9°C (-150 to -100°C)*2
		J	±7.2°C (-200 to -150°C)*2
		T	±2.8°C
		B	±3.1°C (0 to 350°C)*2 ±4.1°C (-100 to 0°C)*2
		R	±5.0°C (-150 to -100°C)*2 ±6.7°C (-200 to -150°C)*2
		S	±3.5°C
	Ambient temperature -20 to 55°C	K	±6.5°C (-100 to 1200°C)*2 ±7.5°C (-150 to -100°C)*2
		J	±8.5°C (-200 to -150°C)*2
		T	±4.5°C
		B	±4.1°C (0 to 350°C)*2 ±5.1°C (-100 to 0°C)*2
		R	±6.0°C (-150 to -100°C)*2 ±7.7°C (-200 to -150°C)*2
		S	±6.5°C
Resolution	K, J, T B, R, S	0.1°C (0.1 to 0.2°F) 0.1 to 0.3°C (0.1 to 0.6°F)	
Conversion speed*3	About 85 ms/channel		
Isolation method	Between input terminal and CPU module: Photocoupler Between input terminal channels: Non-isolation		
Power supply	24 V DC, 20 mA (internal power supply)*4 5 V DC, 10 mA (internal power supply)*4		
Compatible CPU module	FX5UJ: Compatible from initial product FX5U, FX5UC: Ver. 1.040 or later		
Number of occupied I/O points	0 points (no occupied points)		

- *1: Obtaining sufficient accuracy requires a warm-up of 45 minutes (energization).
*2: Accuracy varies depending on the measured temperature range in ().
*3: For details of conversion speeds, refer to the manual.
*4: Current consumption calculation is not required for the FX5UJ CPU module.

● FX5-4AD-PT-ADP

Item	Specifications	
Analog input points	4 points (4 channels)	
External device connection method	European-type terminal block	
Usable resistance temperature detector*1	Pt100 Ni100 (DIN 43760 1987)	
Temperature measuring range	Pt100	-200 to 850°C (-328 to 1562°F)
	Ni100	-60 to 250°C (-76 to 482°F)
Digital output value	16-bit signed binary value	
	Pt100	-2000 to 8500 (-3280 to 1562)
Accuracy	Ni100	-600 to 2500 (760 to 4820)
	Ambient temperature 25±5°C	Pt100
Ni100		±0.4°C
Pt100		±2.4°C
Ni100		±1.2°C
Resolution	0.1°C (0.1 to 0.2°F)	
Conversion speed*2	About 85 ms/channel	
Isolation method	Between input terminal and CPU module: Photocoupler Between input terminal channels: Non-isolation	
Power supply	24 V DC, 20 mA (internal power supply)*3 5 V DC, 10 mA (internal power supply)*3	
Compatible CPU module	FX5UJ: Compatible from initial product FX5U, FX5UC: Ver. 1.040 or later	
Number of occupied I/O points	0 points (no occupied points)	

- *1: Only 3-wire type resistance temperature detectors can be used.
*2: For details of conversion speeds, refer to the manual.
*3: Current consumption calculation is not required for the FX5UJ CPU module.

General, Power Supply, Input/Output Specifications

● FX5-4DA-ADP

Item	Specifications			
Analog output points	4 points (4 channels)			
External device connection method	European-type terminal block			
Analog output voltage	-10 to +10 V DC (external load resistance value 1 kΩ to 1 MΩ)			
Analog output current	0 to 20 mA DC (external load resistance value 0 to 500 Ω)			
Digital input	14-bit binary value			
Output characteristics, resolution*1	Analog output range		Resolution	
	Voltage	0 to 10 V	0 to 16000	625 μV
		0 to 5 V	0 to 16000	312.5 μV
		1 to 5 V	0 to 16000	250 μV
	Current	-10 to +10 V	-8000 to +8000	1250 μV
		0 to 20 mA	0 to 16000	1.25 μA
4 to 20 mA		0 to 16000	1 μA	
Accuracy (Accuracy in respect to full-scale analog output value)	Ambient temperature 25±5°C: within ±0.1% (Voltage ±20 mV, Current ±20 μA) Ambient temperature -20 to 55°C*: within ±0.2% (Voltage ±40 mV, Current ±40 μA)			
Conversion speed	Maximum 950 μs (The data will be updated at every scan time of the PLC.)			
Isolation method	Between output terminal and PLC: Photocoupler Between output terminal channels: Non-isolation			
Power supply	24 V DC +20%, -15% 160 mA (external power supply) 5 V DC, 10 mA (internal power supply)*3			
Compatible CPU module	FX5UJ, FX5U, FX5UC			
Number of occupied input/output points	0 points (no occupied points)			

*1: For details on the output conversion characteristic, refer to manuals of each product.

*2: The ambient temperature specification is 0 to 55°C for products manufactured earlier than June 2016.

*3: Current consumption calculation is not required for the FX5UJ CPU module.

◇ Expansion board

Item	Specifications		
	FX5-232-BD	FX5-485-BD	FX5-422-BD-GOT
Transmission standards	Conforming to RS-232C	Conforming to RS-485, RS-422	Conforming to RS-422
Maximum transmission distance	15 m	50 m	According to the specification of the GOT
External device connection method	9-pin D-sub, male	European-type terminal block	8-pin MINI-DIN, female
Insulation	Non-isolation (between communication line and CPU)	Non-isolation (between communication line and CPU)	Non-isolation (between communication line and CPU)
Communication method	Half-duplex bidirectional/full duplex bidirectional*1	Half-duplex bidirectional/full duplex bidirectional*1	Half-duplex bidirectional
Protocol type	MELSOFT connection, MC protocol (1C/3C/4C frame), non-protocol communication, MODBUS RTU communication, predefined protocol support	MELSOFT connection, MC protocol (1C/3C/4C frame), non-protocol communication, MODBUS RTU communication, inverter communication, N:N network, parallel link, predefined protocol support	—
Baud rate	300/600/1200/2400/4800/9600/19200/38400/57600/115200 (bps)*1	300/600/1200/2400/4800/9600/19200/38400/57600/115200 (bps)*1	9600/19200/38400/57600/115200 (bps)
Terminal resistors	—	Built-in (OPEN/110 Ω/330 Ω)	—
Power supply	5 V DC, 20 mA (internal power supply)*2	5 V DC, 20 mA (internal power supply)*2	5 V DC, 20 mA (internal power supply)*2*3
Compatible CPU module	FX5UJ, FX5U	FX5UJ, FX5U	FX5UJ, FX5U
Number of occupied input/output points	0 points (no occupied points)	0 points (no occupied points)	0 points (no occupied points)

*1: The communication method and baud rate vary depending on the type of communication.

*2: Current consumption calculation is not required for the FX5UJ CPU module.

*3: When the GOT 5 V type is connected with this product, the power consumption increases. For the current consumption, refer to the manual of the model to be connected.

◇ Extension power supply module

● FX5-1PSU-5V

Item	Specifications	
Rated supply voltage	100 to 240 V AC	
Voltage fluctuation range	-15%, +10%	
Frequency rating	50/60 Hz	
Allowable instantaneous power failure time	Operation can be continued upon occurrence of instantaneous power failure for 10 ms or less.	
Power fuse	250 V, 3.15 A time-lag fuse	
Rush current	25 A Max. 5 ms or less/100 V AC 50 A Max. 5 ms or less/200 V AC	
Power consumption	20 W Max.	
Output current* (For power supply to rear stage)	24 V DC	300 mA (Maximum output current depends on the ambient temperature.)
	5 V DC	1200 mA (Maximum output current depends on the ambient temperature.)
Compatible CPU module	FX5UJ, FX5U (AC power supply type)	
Number of occupied input/output points	0 points (no occupied points)	

*: For details on the current conversion characteristic, refer to manuals of each product.

● FX5-C1PS-5V

Item	Specifications	
Supply voltage	24 V DC	
Voltage fluctuation range	+20%, -15%	
Allowable instantaneous power failure time	Operation can be continued upon occurrence of instantaneous power failure for 5 ms or less.	
Power fuse	125 V, 3.15 A time-lag fuse	
Rush current	35 A Max. 0.5 ms or less/24 V DC	
Power consumption	30 W Max.	
Output current* (For power supply to rear stage)	24 V DC	625 mA (Maximum output current depends on the ambient temperature.)
	5 V DC	1200 mA (Maximum output current depends on the ambient temperature.)
Compatible CPU module	FX5U (DC power supply type), FX5UC	
Number of occupied input/output points	0 points (no occupied points)	

*: For details on the current conversion characteristic, refer to manuals of each product.

For the general specifications for each model, refer to each manual.

◇ Bus conversion module

● FX5-CNV-BUS (FX5 (extension cable type)–FX3 extension)

Item	Specifications
Compatible CPU module	FX5U, FX5UC
Number of occupied input/output points	8 points (Either input or output is available for counting.)
Control power (supplied from PLC)	5 V DC 150 mA

● FX5-CNV-BUSC (FX5 (extension connector type)–FX3 extension)

Item	Specifications
Compatible CPU module	FX5U, FX5UC
Number of occupied input/output points	8 points (Either input or output is available for counting.)
Control power (supplied from PLC)	5 V DC 150 mA

◇ Connector conversion module

● FX5-CNV-IF (FX5 (extension cable type)–FX5 (extension connector type) extension)

Item	Specifications
Compatible CPU module	FX5UJ, FX5U
Number of occupied input/output points	0 points (no occupied points)
Control power (supplied from PLC)	0 mA (no power consumed)

● FX5-CNV-IFC (FX5 (extension connector type)–FX5 (extension cable type) extension)

Item	Specifications
Compatible CPU module	FX5UC
Number of occupied input/output points	0 points (no occupied points)
Control power (supplied from PLC)	0 mA (no power consumed)

◇ Intelligent function module

● FX5-4AD

Items		Specifications		
Analog input points		4 points (4 channels)		
External device connection method		Spring clamp terminal block		
Analog input voltage		-10 to +10 V DC (Input resistance 400 kΩ or more)		
Analog input current		-20 to +20 mA DC (Input resistance 250 Ω)		
Absolute maximum input		Voltage: ±15 V, Current: ±30 mA		
Input characteristics, resolution*1	Voltage	Analog input range	Digital output value	Resolution
		0 to 10 V	0 to 32000	312.5 μV
		0 to 5 V	0 to 32000	156.25 μV
		1 to 5 V	0 to 32000	125 μV
	Current	-10 to +10 V	-32000 to +32000	312.5 μV
		User range setting	-32000 to +32000	125 μV*2
		0 to 20 mA	0 to 32000	625 nA
		4 to 20 mA	0 to 32000	500 nA
Digital output value	Voltage/Current	16-bit signed binary (-32768 to +32767)		
		Ambient temperature 25±5°C: within ±0.1% (±64 digits)		
Accuracy	Voltage/Current	Ambient temperature 0 to 55°C: within ±0.2% (±128 digits)		
		Ambient temperature -20 to 0°C: within ±0.3% (±192 digits)		
		80 μs/ch		
Conversion speed		80 μs/ch		
Isolation method		Between input terminal and PLC: Photocoupler Between input terminal channels: Non-isolation		
Power supply		24 V DC, 40 mA (internal power supply) 5 V DC, 100 mA (internal power supply)		
Compatible CPU module		FX5UJ: Compatible from initial product FX5U, FX5UC: Ver. 1.050 or later Connection with FX5UC CPU module requires connector conversion module (FX5-CNV-IFC) or extension power supply module (FX5-C1PS-5V).		
Number of occupied I/O points		8 points (Either input or output is available for counting.)		

*1: For details on the input characteristics, refer to the manual.

*2: Maximum resolution in the user range setting.

● FX5-4DA

Items		Specifications		
Analog output points		4 points (4 channels)		
External device connection method		Spring clamp terminal block		
Analog output voltage		-10 to +10 V DC (External load resistance 1 kΩ to 1 MΩ)		
Analog output current		0 to 20 mA DC (External load resistance 0 to 500 Ω)		
Output characteristics, resolution*1	Voltage	Analog output range	Digital value	Resolution
		0 to 10 V	0 to 32000	312.5 μV
		0 to 5 V	0 to 32000	156.3 μV
		1 to 5 V	0 to 32000	125 μV
	Current	-10 to +10 V	-32000 to +32000	312.5 μV
		User range setting	-32000 to +32000	312.5 μV*2
		0 to 20 mA	0 to 32000	625 nA
		4 to 20 mA	0 to 32000	500 nA
Digital input	Voltage/Current	16-bit signed binary (-32768 to +32767)		
		Ambient temperature 25±5°C: within ±0.1% (Voltage ±20 mV, Current ±20 μA)		
Accuracy	Voltage/Current	Ambient temperature 0 to 55°C: within ±0.2% (Voltage ±40 mV, Current ±40 μA)		
		Ambient temperature -20 to 0°C: within ±0.3% (Voltage ±60 mV, Current ±60 μA)		
		80 μs/ch		
Conversion speed		80 μs/ch		
Isolation method		Between output terminal and PLC: Photocoupler Between output channels: Non-isolation		
Power supply		5 V DC, 100 mA (internal power supply) 24 V DC, +20%, -15% 150 mA (external power supply)		
Compatible CPU module		FX5UJ: Compatible from initial product FX5U, FX5UC: Ver. 1.050 or later Connection with FX5UC CPU module requires connector conversion module (FX5-CNV-IFC) or extension power supply module (FX5-C1PS-5V).		
Number of occupied I/O points		8 points (Either input or output is available for counting.)		

*1: For details on the output characteristics, refer to the manual.

*2: Maximum resolution in the user range setting.

For the general specifications for each model, refer to each manual.

General, Power Supply, Input/Output Specifications

● FX5-8AD

Item	Specifications			
Analog input points	8 points (8 channels)			
External device connection method	Spring clamp terminal block			
Analog input voltage	-10 to +10 V DC (input resistance 1 MΩ)			
Analog input current	-20 to +20 mA DC (input resistance 250 Ω)			
Absolute maximum input	Voltage: ±15 V, Current: ±30 mA			
Input characteristics, resolution	Thermocouple	K, J, T: 0.1°C (0.1 to 0.2°F) B, R, S: 0.1 to 0.3°C (0.1 to 0.6°F)		
	Resistance temperature detector	0.1°C (0.2°F)		
	Voltage	Analog input range	Digital output value	Resolution
		0 to 10 V	0 to 32000	312.5 μV
		0 to 5 V	0 to 32000	156.25 μV
		1 to 5 V	0 to 32000	125 μV
Current	-10 to +10 V	-32000 to +32000	312.5 μV	
	0 to 20 mA	0 to 32000	625 nA	
	4 to 20 mA	0 to 32000	500 nA	
Digital output value (16-bit signed binary value)	Thermocouple	K: -2000 to +12000 (-3280 to +21920) J: -400 to +7500 (-400 to +13820) T: -2000 to +3500 (-3280 to +6620) B: 6000 to 17000 (11120 to 30920) R: 0 to 16000 (320 to 29120) S: 0 to 16000 (320 to 29120)		
		Resistance temperature detector	Pt100: -2000 to +8500 (-3280 to +15620) Ni100: -600 to +2500 (-760 to +4820)	
	Voltage/Current	16-bit signed binary (-32000 to +32000)		
	Accuracy*	Resistance temperature detector	Ambient temperature 25±5°C	Pt100: ±0.8°C Ni100: ±0.4°C
Thermocouple		Ambient temperature -20 to 55°C	Pt100: ±2.4°C Ni100: ±1.2°C	
		Ambient temperature 25±5°C	K: ±3.5°C (-200 to -150°C) K: ±2.5°C (-150 to -100°C) K: ±1.5°C (-100 to 1200°C) J: ±1.2°C T: ±3.5°C (-200 to -150°C) T: ±2.5°C (-150 to -100°C) T: ±1.5°C (-100 to 350°C) B: ±2.3°C R: ±2.5°C S: ±2.5°C	
		Ambient temperature -20 to 55°C	K: ±8.5°C (-200 to -150°C) K: ±7.5°C (-150 to -100°C) K: ±6.5°C (-100 to 1200°C) J: ±3.5°C T: ±5.2°C (-200 to -150°C) T: ±4.2°C (-150 to -100°C) T: ±3.1°C (-100 to 350°C) B: ±6.5°C R: ±6.5°C S: ±6.5°C	
		Ambient temperature 25±5°C	Within ±0.3% (±192 digits)	
Voltage/Current		Ambient temperature -20 to 55°C	Within ±0.5% (±320 digits)	
Conversion speed	Voltage/Current	1 ms/ch		
	Thermocouple/Resistance temperature detector	40 ms/ch		
Isolation method	Between input terminal and PLC: Photocoupler Between input terminal channels: Non-isolation			
Power supply	24 V DC, 40 mA (internal power supply) 24 V DC +20%, -15% 100 mA (external power supply)			
Compatible CPU module	FX5UJ: Compatible from initial product FX5U, FX5UC: Ver. 1.050 or later Connection with FX5UC CPU module requires connector conversion module (FX5-CNV-IFC) or extension power supply module (FX5-C1PS-5V).			
Number of occupied I/O points	8 points (Either input or output is available for counting.)			

*: To stabilize the accuracy, warm-up (supply power) the system for 30 minutes or more after power-on.

For the general specifications for each model, refer to each manual.

General, Power Supply, Input/Output Specifications

● FX5-4LC

Item	Specifications		
Control system	Two-position control, standard PID control, heating/cooling PID control, cascade control		
External device connection method	Spring clamp terminal block		
Control operation cycle	250 ms/4 ch		
Temperature measuring range	Thermocouple	K: -200 to +1300°C (-100 to +2400°F) J: -200 to +1200°C (-100 to +2100°F) T: -200 to +400°C (-300 to +700°F) S: 0 to 1700°C (0 to 3200°F) R: 0 to 1700°C (0 to 3200°F) E: -200 to +1000°C (0 to 1800°F) B: 0 to 1800°C (0 to 3000°F) N: 0 to 1300°C (0 to 2300°F) PLI: 0 to 1200°C (0 to 2300°F) W5Re/W26Re: 0 to 2300°C (0 to 3000°F) U: -200 to +600°C (-300 to +700°F) L: 0 to 900°C (0 to 1600°F)	
	Resistance temperature detector	Pt100 (3-wire type): -200 to +600°C (-300 to +1100°F) JPt100 (3-wire type): -200 to +500°C (-300 to +900°F) Pt1000 (2-wire/3-wire type): -200.0 to +650.0°C (-328 to +1184°F)	
	Micro voltage input	0 to 10 mV DC, 0 to 100 mV DC	
Heater disconnection detection	Alarm detection		
Input specifications	Number of input points	4 points	
	Input type	Thermocouple	K, J, R, S, E, T, B, N, PLII, W5Re/W26Re, U, L
		Resistance temperature detector	3-wire type Pt100 3-wire type JPt100 2-wire/3-wire type Pt1000
		Micro voltage input	
	Measurement accuracy	Refer to the MELSEC iQ-F FX5 User's Manual (Temperature Control).	
	Cold junction temperature compensation error	Ambient temperature 0 to 55°C	Within ±1.0°C. When the input value is -150 to -100°C: Within ±2.0°C When the input value is -200 to -150°C: Within ±3.0°C
		Ambient temperature -20 to 0°C	Within ±1.8°C. When the input value is -150 to -100°C: Within ±3.6°C When the input value is -200 to -150°C: Within ±5.4°C
	Resolution	0.1°C (0.1°F), 1.0°C (1.0°F), 0.5 μV, or 5.0 μV (depends on the input range of the sensor used)	
	Sampling cycle	250 ms/4 ch	
	Influence of input conductor resistance (for resistance temperature detector input)	3-wire type	About 0.03%/Ω for full scale, and 10 Ω or less per line
		2-wire type	About 0.04%/Ω for full scale, and 7.5 Ω or less per line
	Influence of external resistance (for thermocouple input)	About 0.125 μV/Ω	
Input impedance	1 MΩ or more		
Sensor current	About 0.2 mA (for resistance temperature detector input)		
Operation at input disconnection/short circuit	Upscale/downscale (for resistance temperature detector input)		
Output specifications	Number of points: 4 Type: NPN open collector transistor output, Rated load voltage: 5 to 24 V DC Maximum load current: 100 mA, Control output cycle: 0.5 to 100.0 seconds		
Power supply	5 V DC, 140 mA (internal power supply) 24 V DC +20%, -15% 25 mA (external power supply)		
Isolation method	<ul style="list-style-type: none"> The analog input part and between the transistor output part and PLC are insulated by the photocoupler. The analog input part and between the transistor output part and power supply are insulated by the DC-DC converter. Insulated between channels 		
Compatible CPU module	FX5UJ: Compatible from initial product FX5U, FX5UC: Ver. 1.050 or later Connection with FX5UC CPU module requires connector conversion module (FX5-CNV-IFC) or extension power supply module (FX5-C1PS-5V).		
Number of occupied I/O points	8 points (Either input or output is available for counting.)		

● FX5-20PG-P, FX5-20PG-D

Item	Specifications	
	FX5-20PG-P	FX5-20PG-D
Number of control axes	2 axes	
Command Speed	200 kpps	5 Mpps
Pulse Output	Output signal: PULSE/SIGN mode, CW/CCW mode, phase A/B (4 multiplication), phase A/B (1 multiplication) Output terminal: Transistor 5 to 24 V DC 50 mA or less	Output signal: PULSE/SIGN mode, CW/CCW mode, phase A/B (4 multiplication), phase A/B (1 multiplication) Output terminal: Differential driver equivalent to AM26C31
External I/O specifications	Input: READY/STOP/FLS/RLS/PG024/DOG/CHG terminals: 24 V DC 5 mA, PULSER A/PULSER B terminals: 5 V DC 14 mA Zero point signal PG05 terminal: 5 V DC 5 mA Output: CLEAR (deviation counter): 5 to 24 V DC 100 mA or less Circuit insulation: Photocoupler	
Power supply	24 V DC +20%, -15% 120 mA (external power supply)	24 V DC +20%, -15% 165 mA (external power supply)
Compatible CPU module	FX5UJ: Compatible from initial product FX5U, FX5UC: Ver. 1.050 or later Connection with FX5UC CPU module requires connector conversion module (FX5-CNV-IFC) or extension power supply module (FX5-C1PS-5V).	
Number of occupied I/O points	8 points (Either input or output is available for counting.)	

General, Power Supply, Input/Output Specifications

● FX5-ENET

Items		Specifications		
CC-Link IE Field Network Basic	Station type	Master station		
	Maximum number of connectable stations*1	32		
	Number of stations occupied by a slave station	1 to 4		
	Maximum number of link points per network	RX	2048 points	
		RY	2048 points	
		RWr	1024 points	
		RWw	1024 points	
	Maximum number of link points per station	Master station	RX	2048 points
			RY	2048 points
			RWr	1024 points
			RWw	1024 points
		Slave station*2	RX	64/128/192/256 points
			RY	64/128/192/256 points
			RWr	32/64/96/128 points
			RWw	32/64/96/128 points
	UDP port number used in the cyclic transmission		61450	
	UDP port number used in automatic detection of connected devices		Master station: An unused port number is assigned automatically. Slave station: 61451	
	Transmission specifications	Data transfer speed	100 Mbps	
Maximum station-to-station distance		100 m		
Overall cable distance		Depends on the system configuration		
Number of cascade connections		100BASE-TX When using a switching hub, check the number of cascaded stages with the manufacturer of the hub to be used.		
Network topology		Consult the manufacturer.		
Hub*3		Hubs with 100BASE-TX ports*4 can be used.		
Connection cable*5		100BASE-TX Ethernet cable of category 5 or higher (STP cable)		
General-purpose Ethernet communication	Transmission specifications	Data transfer speed	100/10 Mbps	
		Communication mode	Full-duplex or half-duplex*3	
		Transmission method	Base band	
		Interface	RJ45 connector	
		Maximum segment length (Maximum distance between hub and node)	100 m*6	
		Number of cascade connections	100BASE-TX 10BASE-T 2 levels maximum*7 4 levels maximum*7	
	Protocol type*8		MELSOFT connection, SLMP server (3E/1E frame), Socket communication, simple CPU communication, BACnet/IP	
	Number of connections		Total of 32 connections*9 (Up to 32 external devices can access one FX5-ENET module at the same time.)	
	Hub*3		Hubs with 100BASE-TX or 10BASE-T ports*10 can be used.	
	Connection cable*5		100BASE-TX 10BASE-T Ethernet cable of category 5 or higher (STP cable) Ethernet cable of category 3 or higher (STP/UTP cable)	
Number of ports		2*11		
Power supply		24 V DC, 110 mA (internal power supply)		
Compatible CPU module		FX5UJ: Compatible from initial product FX5U, FX5UC: Ver. 1.110 or later Connection with FX5UC CPU module requires connector conversion module (FX5-CNV-IFC) or extension power supply module (FX5-C1PS-5V).		
Number of occupied I/O points		8 points (Either input or output is available for counting.)		

*1 : Maximum number of connected slave stations that FX5-ENET (master station) can manage.

*2 : Value for 1-station occupation, 2-station occupation, 3-station occupation, or 4-station occupation.

*3 : IEEE802.3x flow control is not supported.

*4 : The ports must comply with the IEEE802.3 100BASE-TX standards.

*5 : A straight/cross cable can be used.

*6 : For maximum segment length (length between hubs), consult the manufacturer of the hub used.

*7 : This number applies when a repeater hub is used. When using a switching hub, check the number of cascaded stages with the manufacturer of the hub to be used.

*8 : For a compatible version of each protocol, refer to the following manual.

→ MELSEC iQ-F FX5-ENET User's Manual

*9 : The first device for MELSOFT connection is not included in the number of connections. (The second and the following devices are included.)

The CC-Link IE field network Basic is not included in the number of connections.

*10: The ports must comply with the IEEE802.3 100BASE-TX or IEEE802.3 10BASE-T standards.

*11: Since the IP address is shared by two ports, only one address can be set.

For the general specifications for each model, refer to each manual.

General, Power Supply, Input/Output Specifications

● FX5-ENET/IP

Items		Specifications	
EtherNet/IP communications	Class 1 communications	Communication format	Standard EtherNet/IP
		Number of connections	32
		Communication data size	1444 bytes (per connection)
		Connection type	Point-to-point, multicast
		RPI (communication cycle)	2 to 60000 ms
		PPS (communication processing performance)	3000 pps (case of 128 bytes)
	Class 3 communications*1	Communication format	Standard EtherNet/IP
		Number of connections	32*2
		Connection type	Point-to-point
	UCMM communications	Communication format	Standard EtherNet/IP
		Number of connections (number of simultaneous executions)	32*2
		Communication data size	1414 bytes*3
		Connection type	Point-to-point
	Transmission specifications	Data transmission speed	100 Mbps
		Communication mode	Full-duplex
		Transmission method	Base band
		Interface	RJ45 connector
		IP version	IPv4 is supported.
Maximum segment length		100 m (length between hub and node)*4	
Number of cascade connections		100BASE-TX 2 levels maximum*5	
Network topology	Star topology, line pology		
Hub*6	Hubs with 100BASE-TX ports*7 can be used.		
Connection cable*8	100BASE-TX Ethernet cable of category 5 or higher (STP cable)		
General-purpose Ethernet communication	Transmission specifications	Data transfer speed	100/10 Mbps
		Communication mode	Full-duplex or half-duplex*6
		Transmission method	Base band
		Interface	RJ45 connector
		Maximum segment length	100 m (length between hub and node)*4
		Number of cascade connections	100BASE-TX 2 levels maximum*5 10BASE-T 4 levels maximum*5
	Protocol type*9	MELSOFT connection, SLMP server (3E/1E frame), socket communication, simple CPU communication, BACnet/IP	
	Number of connections	Total of 32 connections*10 (Up to 32 external devices can access one FX5-ENET/IP module at the same time.)	
	Hub*6	Hubs with 100BASE-TX or 10BASE-T ports*11 can be used.	
	Connection cable*8	100BASE-TX Ethernet cable of category 5 or higher (STP cable) 10BASE-T Ethernet cable of category 3 or higher (STP/UTP cable)	
Number of ports	2*12		
Power supply	24 V DC, 110 mA (internal power supply)		
Compatible CPU module	FX5UJ: Compatible from initial product FX5U, FX5UC: Ver. 1.110 or later Connection with FX5UC CPU module requires connector conversion module (FX5-CNV-IFC) or extension power supply module (FX5-C1PS-5V).		
Number of occupied I/O points	8 points (Either input or output is available for counting.)		

*1 : Class 3 communication supports the server functions.

*2 : The total number of connections for Class 3 communications and UCMM communications is 32.

*3 : This size is the maximum size which can be specified to 'Data length' of Class 1 communication input data area of the request command during the client operation.
During the sever operation, since the FX5-ENET/IP automatically responds according to the request command received from the client, the maximum size is not prescribed.

*4 : For maximum segment length (length between hubs), consult the manufacturer of the hub used.

*5 : This number applies when a repeater hub is used. When using a switching hub, check the number of cascaded stages with the manufacturer of the hub to be used.

*6 : IEEE802.3x flow control is not supported.

*7 : The ports must comply with the IEEE802.3 100BASE-TX standards.

*8 : A straight/cross cable can be used.

*9 : For a compatible version of each protocol, refer to the following manual.

→ MELSEC iQ-F FX5-ENET User's Manual

*10: The first device for MELSOFT connection is not included in the number of connections. (The second and the following devices are included.)

The CC-Link IE field network Basic is not included in the number of connections.

*11: The ports must comply with the IEEE802.3 100BASE-TX or IEEE802.3 10BASE-T standards.

*12: Since the IP address is shared by two ports, only one address can be set.

General, Power Supply, Input/Output Specifications

● FX5-CCL-MS

Item		Specifications									
Compatible functions		Master station or intelligent device station									
CC-Link supported version		Ver. 2.00 and Ver. 1.10									
Transmission Speed		<ul style="list-style-type: none"> Master station: 156 kbps/625 kbps/2.5 Mbps/5 Mbps/10 Mbps Intelligent device station: 156 kbps/625 kbps/2.5 Mbps/5 Mbps/10 Mbps/auto-tracking 									
Station number		<ul style="list-style-type: none"> Master station: 0 Intelligent device station: 1 to 64 									
Connectable station type (at the time of master station)		Remote I/O station, remote device station, and intelligent device station (local station and standby master station cannot be connected)									
Maximum overall cable length		1200 m (varies depending on transmission speed)									
Maximum number of connected stations (at the time of master station)		<ul style="list-style-type: none"> ■FX5UJ CPU module <ul style="list-style-type: none"> Remote I/O stations: 6 maximum (The total number of I/O points of remote I/O station is 192 or less.) The total number of intelligent device stations + remote device stations: 8 maximum (The total number of I/O points of intelligent device station + remote device station is 256 or less.) ■FX5U/FX5UC CPU module*3 <ul style="list-style-type: none"> Remote I/O stations: 14 maximum (The total number of I/O points of remote I/O station is 448 or less.) The total number of remote device stations + intelligent device stations: 14 maximum (The total number of I/O points of intelligent device station + remote device station is 448 or less.) 									
Number of occupied stations (at the time of intelligent device station)		1 to 4 stations									
Maximum number of link points per system*3	CC-Link Ver. 1	<ul style="list-style-type: none"> ■FX5UJ CPU module <ul style="list-style-type: none"> Remote I/O (RX, RY): 448 points (remote I/O station: 192 points*1 + remote device stations and intelligent device stations: 256 points) Remote register (RWw): 32 points ■FX5U/FX5UC CPU module*3 <ul style="list-style-type: none"> Remote I/O (RX, RY): 896 points (remote I/O station: 448 points*1 + remote device stations and intelligent device stations: 448 points) Remote register (RWw): 56 points 									
	CC-Link Ver. 2	<ul style="list-style-type: none"> ■FX5UJ CPU module <ul style="list-style-type: none"> Remote I/O (RX, RY): 448 points (remote I/O station: 192 points*1 + remote device stations and intelligent device stations: 256 points) Remote register (RWw): 64 points ■FX5U/FX5UC CPU module*3 <ul style="list-style-type: none"> Remote I/O (RX, RY): 896 points (remote I/O station: 448 points*1 + remote device stations and intelligent device stations: 448 points) Remote register (RWw): 112 points 									
		CC-Link Ver. 2									
Number of link points*3	Extended cyclic setting Number of occupied stations	CC-Link Ver. 1									
		Single									
		Double									
		Quadruple									
		Octuple									
		Remote I/O	Remote register	Remote I/O	Remote register	Remote I/O	Remote register	Remote I/O	Remote register	Remote I/O	Remote register
1 station occupied		RX, RY: 32 points (16 points)*2	RWw: 4 points RW: 4 points	RX, RY: 32 points (16 points)*2	RWw: 4 points RW: 4 points	RX, RY: 32 points (16 points)*2	RWw: 8 points RW: 8 points	RX, RY: 64 points (48 points)*2	RWw: 16 points RW: 16 points	RX, RY: 128 points*4 (112 points)*2*4	RWw: 32 points*4 RW: 32 points*4
2 station occupied		RX, RY: 64 points (48 points)*2	RWw: 8 points RW: 8 points	RX, RY: 64 points (48 points)*2	RWw: 8 points RW: 8 points	RX, RY: 96 points (80 points)*2	RWw: 16 points RW: 16 points	RX, RY: 192 points (176 points)*2	RWw: 32 points RW: 32 points	RX, RY: 384 points*4 (368 points)*2*4	RWw: 64 points*4 RW: 64 points*4
3 station occupied		RX, RY: 96 points (80 points)*2	RWw: 12 points RW: 12 points	RX, RY: 96 points (80 points)*2	RWw: 12 points RW: 12 points	RX, RY: 160 points (144 points)*2	RWw: 24 points RW: 24 points	RX, RY: 320 points*4 (304 points)*2*4	RWw: 48 points*4 RW: 48 points*4		
4 station occupied		RX, RY: 128 points (112 points)*2	RWw: 16 points RW: 16 points	RX, RY: 128 points (112 points)*2	RWw: 16 points RW: 16 points	RX, RY: 224 points (208 points)*2	RWw: 32 points RW: 32 points	RX, RY: 448 points*4 (432 points)*2*4	RWw, RW: 64 points*4 (64 points)*4		
Transmission cable		CC-Link Ver. 1.10 compatible CC-Link dedicated cable									
Compatible CPU module		FX5UJ: Compatible from initial product FX5U, FX5UC: Ver. 1.050 or later Connection with FX5UC CPU module requires connector conversion module (FX5-CNV-IFC) or extension power supply module (FX5-C1PS-5V).									
Communication method		Broadcast polling method									
Transmission format		HDLC compliant									
Error control system		CRC (X ¹⁶ + X ¹² + X ⁵ + 1)									
Power supply		24 V DC +20%, -15% 100 mA (external power supply)									
Number of occupied I/O points		8 points (Either input or output is available for counting.)									

* 1: The number of remote I/O points that can be used CPU module varies depending on the number of input/output points of the extension device.

For the limit of the number of I/O points, refer to the following manual.

→ MELSEC iQ-F FX5UJ User's Manual (Hardware)

→ MELSEC iQ-F FX5U User's Manual (Hardware)

→ MELSEC iQ-F FX5UC User's Manual (Hardware)

* 2: The numbers in parentheses are the points that can be used when the module is an intelligent device station.

* 3: Number of links with FX5U/FX5UC CPU module Ver. 1.100 or later. GX Works3 Ver. 1.047Z or later required. For details on the number of links with FX5U/FX5UC CPU module earlier than Ver. 1.100, refer to the following manual.

→ MELSEC iQ-F FX5 User's Manual (CC-Link)

* 4: Not applicable to the FX5UJ CPU module. For details, refer to the following manual.

→ MELSEC iQ-F FX5 User's Manual (CC-Link)

● FX5-CCLIEF

Item		Specifications
Station type		Intelligent device station
Station number		1 to 120 (sets by parameter or program)
Communication speed		1 Gbps
Network topology		Line topology, star topology (coexistence of line topology and star topology is also possible), and ring topology
Maximum station-to-station distance		Max. 100 m (Conforming to ANSI/TIA/EIA-568-B (Category 5e))
Cascade connection		Max. 20 stages
Communication method		Token passing
Maximum number of link points*1	RX	384 points, 48 bytes
	RY	384 points, 48 bytes
	RWr	1024 points, 2048 bytes*2
	RWw	1024 points, 2048 bytes*2
Compatible CPU module		FX5UJ: Compatible from initial product FX5U, FX5UC Ver. 1.030 or later. Connection with FX5UC CPU module requires connector conversion module (FX5-CNV-IFC) or extension power supply module (FX5-C1PS-5V).
Power supply		5 V DC, 10 mA (internal power supply) 24 V DC, 230 mA (external power supply)
Number of occupied I/O points		8 points (Either input or output is available for counting.)

* 1: The maximum number of link points that a master station can assign to one FX5-CCLIEF module.

* 2: 256 points (512 bytes) when the mode of the master station is online (High-Speed Mode).

For the general specifications for each model, refer to each manual.

General, Power Supply, Input/Output Specifications

● FX5-CCLGN-MS

Items		Specifications	
Station type		Master or local station	
Station number		<ul style="list-style-type: none"> Master station: 0 Local station: 1 to 120 	
Maximum number of link points per network		RX	16 K points (16384 points, 2 K bytes)
		RY	16 K points (16384 points, 2 K bytes)
		RWr	8 K points (8192 points, 16 K bytes)
		RWw	8 K points (8192 points, 16 K bytes)
Maximum number of link points per station*1		Master station	
		RX	8 K points (8192 points, 1 K bytes)
		RY	8 K points (8192 points, 1 K bytes)
		RWr	4 K points (4096 points, 8 K bytes)
		RWw	4 K points (4096 points, 8 K bytes)
		Local station	
		RX	16 K points (16384 points, 2 K bytes)
		RY	16 K points (16384 points, 2 K bytes)
RWr	8 K points (8192 points, 16 K bytes)		
RWw	8 K points (8192 points, 16 K bytes)		
Communication speed		1 Gbps	
Minimum synchronization cycle		250.00 µs	
Authentication Class		Authentication Class B device	
Maximum number of connectable stations		When used as a master station	61*2
		When used as a local station	121
Station-based data assurance		When used as a master station	61*2
		When used as a local station	121
Connection cable		For details, refer to MELSEC iQ-F FX5 User's Manual (CC-Link IE TSN).	
Overall cable distance		Line topology	12000 m (when 121 stations are connected)
		Others	Depends on the system configuration.
Maximum station-to-station distance		100 m	
Network number setting range		1 to 239	
Network topology		Line topology, star topology (coexistence of line topology and star topology is also possible)	
Communication method		Time sharing method	
Transient transmission capacity		1920 bytes	
Compatible CPU module		FX5U, FX5UC: Ver. 1.210 or later Connection with FX5UC CPU module requires connector conversion module (FX5-CNV-IFC) or extension power supply module (FX5-C1PS-5V).	
Power supply		24 V DC 220 mA (external power supply)	
Number of occupied I/O points		8 (Either input or output is available for counting.)	

*1: The maximum number of points for all link devices may not be used simultaneously depending on the number of slave stations, or the number of points and assignments of the link devices that are set in the "Network Configuration Settings" of the "Basic Settings".

*2: The maximum number of connectable stations (61) includes the master station. When connecting multiple master stations, such as the FX5-CCLGN-M and the FX5-40/80SSC-G, which use slave station parameters for the CPU module, the total number of slave stations must be less than or equal to the number of slave station parameter files that can be saved in the CPU module. For details about the number of slave station parameter files that can be saved in the CPU module, refer to the following manual.
→ MELSEC iQ-F FX5 User's Manual (Application)

● FX5-ASL-M

Item	Specifications
Transmission clock	27.0 kHz
Maximum transmission distance (total extension distance)	200 m*1
Transmission system	DC power supply superimposed total frame/cyclic system
Connection type	Bus type (multi-drop method, T-branch method, tree branch method)
Transmission protocol	Dedicated protocol (AnyWireASLINK)
Error control	Checksum, double check method
Number of connected I/O points	<ul style="list-style-type: none"> FX5UJ: Up to 216 points*2 (192 input points maximum/192 output points maximum) FX5U, FX5UC: Up to 448 points*2*3 (256 input points maximum/256 output points maximum)
Number of connected slave modules	Up to 128 modules (the number varies depending on the current consumption of each slave module)
External interface	7-piece spring clamp terminal block push-in type
RAS function	<ul style="list-style-type: none"> Transmission line disconnection position detection function Transmission line short-circuit detection function Transmission power drop detection function
Transmission line (DP, DN)	<ul style="list-style-type: none"> UL-compliant general-purpose 2-wire cable UL-compliant general-purpose cable For dedicated flat cables
Power cable (24 V, 0 V)	
Memory	Built-in memory EEPROM (rewrite endurance: 100 thousand times)
Compatible CPU module	FX5UJ: Compatible from initial product FX5U, FX5UC: Ver. 1.050 or later Connection with FX5UC CPU module requires connector conversion module (FX5-CNV-IFC) or extension power supply module (FX5-C1PS-5V).
Power supply	5 V DC, 200 mA (internal power supply) 24 V DC +15%, -10% 100 mA (external power supply)
Number of occupied I/O points	8 (Either input or output is available for counting.)

*1: For the slave module in which the transmission line (DP, DN) and module body are integrated, the length of the transmission line (DP, DN) is also included in the total extension. When laying a 4-wire (DP, DN, 24 V, 0 V) line for fifty meters or more, insert a power line noise filter between the power supply and the line. For details, refer to the manual of ASLINK filter (ANF-01) made by Anywire Corporation.

*2: The number of remote I/O points that can be used CPU module varies depending on the number of input/output points of the extension device. For the limit of the number of I/O points, refer to the following manual.
→ MELSEC iQ-F FX5UJ User's Manual (Hardware)
→ MELSEC iQ-F FX5U User's Manual (Hardware)
→ MELSEC iQ-F FX5UC User's Manual (Hardware)

*3: Supported by FX5U/FX5UC CPU module Ver. 1.100 or later and by GX Works3 Ver. 1.047Z or later.

For the general specifications for each model, refer to each manual.

General, Power Supply, Input/Output Specifications

● FX5-DP-M

Items		Specifications
PROFIBUS-DP station type		Class 1 master station
Transmission specifications	Electrical standard and characteristics	Compliant with EIA-RS485
	Medium	Shielded twisted pair cable
	Network configuration	Bus topology (or tree topology when repeaters are used)
	Data link method	Between DP-Masters: Token passing Between DP-Master and DP-Slave: Polling
	Encoding method	NRZ
	Transmission speed*1	9.6 kbps, 19.2 kbps, 93.75 kbps, 187.5 kbps, 500 kbps, 1.5 Mbps, 3 Mbps, 6 Mbps, 12 Mbps
	Transmission distance	Differs depending on transmission speed*2
	Maximum number of repeaters (Between DP-Master and DP-Slave)	3 repeaters
	Number of connectable modules (per segment)	32 per segment (including repeaters)
	Maximum number of DP-Slaves	64 modules*3
	Number of connectable nodes (number of repeaters)	32, 62 (1), 92 (2), 122 (3), 126 (4)
Transmittable data	Input data	Max. of 2048 bytes (Max. of 244 bytes per DP-Slave)
	Output data	Max. of 2048 bytes (Max. of 244 bytes per DP-Slave)
Power supply		24 V DC, 150 mA (internal power supply)
Compatible CPU module		FX5UJ: Compatible from initial product FX5U, FX5UC: Ver. 1.110 or later Connection with FX5UC CPU module requires connector conversion module (FX5-CNV-IFC) or extension power supply module (FX5-C1PS-5V).
Number of occupied I/O points		8 points (Either input or output is available for counting.)

*1: Transmission speed accuracy is within $\pm 0.2\%$ (compliant with IEC61158-2).

*2: For details on the transmission distance, refer to the manual.

*3: For details on the PROFIBUS-DP network configuration, refer to the manual.

● FX5-OPC

Items		Specifications	
OPC UA server	OPC UA version	1.03	
	Profile	Micro Embedded Device Server Profile For details, refer to the manual.	
	Service	For details, refer to the manual.	
	Address space	For details, refer to the manual.	
	User authentication	User name and password	
	Maximum number of parallel sessions	4	
	Maximum number of subscriptions per session	2	
	Maximum number of monitored items per subscription	500	
	Minimum sampling interval of a monitored item	100 ms	
	Maximum number of trusted certificates	10	
	Time information	For details, refer to the manual.	
Network topology		Star topology	
Ethernet	Transmission specifications	Data transmission speed	100/10 Mbps
		Communication mode	Full-duplex or half-duplex*1
		Transmission method	Base band
		Interface	RJ45 connector
		Maximum segment length	100 m*2
	Number of cascade connections	100BASE-TX	2 levels maximum*3
		10BASE-T	4 levels maximum*3
Hub*1	Hubs with 100BASE-TX or 10BASE-T ports*4 can be used.		
Connection cable*5	100BASE-TX, 10BASE-T		
Number of ports		2	
Number of occupied I/O points		8 points	
Power supply		24 V DC, 110 mA (internal power supply)	
Compatible CPU module		FX5U, FX5UC: Ver. 1.245 or later Connection with FX5UC CPU module requires connector conversion module (FX5-CNV-IFC) or extension power supply module (FX5-C1PS-5V).	

1: IEEE802.3x flow control is not supported.

2: For maximum segment length (length between hubs), consult the manufacturer of the hub used.

3: This number applies when a repeater hub is used. When using a switching hub, check the number of cascaded stages with the manufacturer of the hub to be used.

4: The ports must comply with the IEEE802.3 100BASE-TX or IEEE802.3 10BASE-T standards.

5: A straight/cross cable can be used.

For the general specifications for each model, refer to each manual.

◇ Simple motion module

- FX5-40SSC-S
- FX5-80SSC-S

Control specification

Item		Specifications	
		FX5-40SSC-S	FX5-80SSC-S
Number of control axes (Virtual servo amplifier axis included)		Max. 4 axes	Max. 8 axes
Operation cycle (Operation cycle settings) [ms]		0.888/1.777	
Interpolation function		Linear interpolation (up to 4-axis, 2-axis circular interpolation)	
Control system		PTP (Point To Point) control, Trajectory control (both linear and arc), Speed control, Speed-position switching control, Position-speed switching control, Speed-torque control	
Acceleration/deceleration process		Trapezoidal acceleration/deceleration, S-curve acceleration/deceleration	
Compensation function		Backlash compensation, Electronic gear, Near pass function	
Synchronous control	Input axis	Servo input axis, synchronous encoder axis, command generation axis	
	Output axis	Cam shaft	
Cam control	Number of registered cams*1	Up to 64 cams	Up to 128 cams
	Cam data format	Stroke ratio data format, coordinate data format	
	Automatic generation of cam	Automatic generation of cam for rotary cutter	
Control unit		mm, inch, degree, pulse	
Number of positioning data		600 data (positioning data No. 1 to 600)/axis (Can be set with MELSOFT GX Works3 or a sequence program.)	
Backup		Parameters, positioning data, and block start data can be saved on flash ROM (battery-less backup)	
Home position return	Home position return method	Proximity dog method, Count method 1, Count method 2, Data set method, Scale home position signal detection method, Driver home position return method	
	Fast home position return control	Provided	
	Auxiliary functions	Home position return retry, Home position shift	
Positioning control	Linear control	Linear interpolation control (Up to 4 axes)*2 (Vector speed, Reference axis speed)	
	Fixed-pitch feed control	Fixed-pitch feed control (Up to 4 axes)	
	2-axis circular interpolation	Auxiliary point-specified circular interpolation, Central point-specified circular interpolation	
	Speed control	Speed control (Up to 4 axes)	
	Speed-position switching control	INC mode, ABS mode	
	Position-speed switching control	INC mode	
	Current value change	Positioning data, Start No. for a current value changing	
	NOP instruction	Provided	
	JUMP instruction	Unconditional JUMP, Conditional JUMP	
	LOOP, LEND	Provided	
	High-level positioning control	Block start, Condition start, Wait start, Simultaneous start, Repeated start	
	Manual control	JOG operation	Provided
Inching operation		Provided	
Manual pulse generator		Possible to connect 1 module (Incremental), Unit magnification (1 to 10000 times)	

Item		Specifications	
		FX5-40SSC-S	FX5-80SSC-S
Expansion control	Speed-torque control	Speed control without positioning loops, Torque control, Tightening & press-fit control	
	Absolute position system	Made compatible by setting a battery to servo amplifier	
Synchronous encoder interface		Up to 4 channels (Total of the internal interface, via PLC CPU interface, and servo amplifier interface)	
Internal interface		1 ch (Incremental)	
Functions that limit control	Speed limit function	Speed limit value, JOG speed limit value	
	Torque limit function	Torque limit value same setting, torque limit value individual setting	
	Forced stop	Valid/Invalid setting	
	Software stroke limit function	Movable range check with current feed value, movable range check with machine feed value	
	Hardware stroke limit function	Provided	
Functions that change control details	Speed change function	Provided	
	Override function	1 to 300 [%]	
	Acceleration/deceleration time change function	Provided	
	Torque change function	Provided	
Other functions	Target position change function	Target position address and speed are changeable	
	M-code output function	Provided	
	Step function	Deceleration unit step, Data No. unit step	
	Skip function	Via PLC CPU, Via external command signal	
Teaching function		Provided	
Parameter initialization function		Provided	
External input signal setting function		Via CPU, Via servo amplifier	
Amplifier-less operation function		Provided	
Mark detection function		Continuous Detection mode, Specified Number of Detections mode, Ring Buffer mode	
Mark detection function	Mark detection signal	Up to 4 points	
	Mark detection setting	16 settings	
Optional data monitor function		Up to 4 points/axis	
Driver communication function		Provided	
SSCNET connect/disconnect function		Provided	
Digital oscilloscope function*3	Bit data	16 ch	
	Word data	16 ch	

*1: The number of registered cams varies depending on the memory capacity, cam resolution, and the number of coordinates.

*2: 4-axis linear interpolation control is enabled only at the reference axis speed.

*3: 8 ch word data and 8 ch bit data can be displayed in real time.

General, Power Supply, Input/Output Specifications

Module specification

Item	Specifications	
	FX5-40SSC-S	FX5-80SSC-S
Number of control axes	Max. 4 axes	Max. 8 axes
Servo amplifier connection method	SSCNET III/H	
Maximum overall cable distance [m]	400	800
Maximum distance between stations [m]	100	
Peripheral I/F	Via CPU module (Ethernet)	
Manual pulse generator operation function	Possible to connect 1 module	
Synchronous encoder operation function	Possible to connect 4 modules (Total of the internal interface, via PLC CPU interface, and servo amplifier interface)	
Input signals (DI)	No. of input points	4 points
	Input method	Positive common/Negative common shared (Photocoupler)
	Rated input voltage/current	24 V DC/Approx. 5 mA
	Operating voltage range	19.2 to 26.4 V DC (24 V DC +10%/-20%, ripple ratio 5% or less)
	ON voltage/current	17.5 V DC or more/3.5 mA or more
	OFF voltage/current	7 V DC or less/1.0 mA or less
	Input resistance	Approx. 6.8 kΩ
	Response time	1 ms or less (OFF→ON, ON→OFF)
	Recommended wire size	AWG24 (0.2 mm ²)
Forced stop input signal (EMI)	No. of input points	1 point
	Input method	Positive common/Negative common shared (Photocoupler)
	Rated input voltage/current	24 V DC/Approx. 5 mA
	Operating voltage range	19.2 to 26.4 V DC (24 V DC +10%/-20%, ripple ratio 5% or less)
	ON voltage/current	17.5 V DC or more/3.5 mA or more
	OFF voltage/current	7 V DC or less/1.0 mA or less
	Input resistance	Approx. 6.8 kΩ
	Response time	4 ms or less (OFF→ON, ON→OFF)
	Recommended wire size	AWG24 (0.2 mm ²)

Item	Specifications		
	FX5-40SSC-S	FX5-80SSC-S	
Manual pulse generator / Incremental synchronous encoder signal	Signal input form	Phase A/Phase B (magnification by 4/magnification by 2/magnification by 1), PULSE/SIGN	
	Differential output type (26LS31 or equivalent)	Input pulse frequency	Max. 1 Mpulse/s (After magnification by 4, up to 4 Mpulse/s)
		Pulse width	1 μs or more
		Leading edge/trailing edge time	0.25 μs or less
		Phase difference	0.25 μs or more
		Rated input voltage	5.5 V DC or less
		High/Low-voltage	2.0 to 5.25 V DC/0 to 0.8 V DC
		Differential voltage	±0.2 V
	Cable length	Up to 30 m	
	Voltageoutput/ Opencollector type (5 V DC)	Input pulse frequency	Max. 200 kpulse/s (After magnification by 4, up to 800 kpulse/s)
Pulse width		5 μs or more	
Leading edge/trailing edge time		1.2 μs or less	
Phase difference		1.2 μs or more	
Rated input voltage		5.5 V DC or less	
High/Low-voltage		3.0 to 5.25 V DC/2 mA or less, 0 to 1.0 V DC/5 mA or more	
Cable length		Up to 10 m	
Compatible CPU module	FX5UJ, FX5U, FX5UC: Compatible from initial product Only 1 module may be connected per system. Connection with FX5UC CPU module requires connector conversion module (FX5-CNV-IFC) or extension power supply module (FX5-C1PS-5V).		
Number of occupied input/output points	8 points (Either input or output is available for counting.)		
Power supply	24 V DC +20%/-15% (external power supply)		

◇ Motion module

- FX5-40SSC-G
- FX5-80SSC-G

Control specification

Item		Specifications	
		FX5-40SSC-G	FX5-80SSC-G
Number of control axes (Virtual servo amplifier axis included)		Max. 4 axes	Max. 8 axes
Operation cycle (Operation cycle settings) [ms]		0.500/1.000/2.000/4.000	
Interpolation function		Linear interpolation (up to 4-axis, 2-axis circular interpolation)	
Control system		PTP (Point To Point) control, Trajectory control (both linear and arc), Speed control, Speed-position switching control, Position-speed switching control, Speed-torque control	
Acceleration/deceleration process		Trapezoidal acceleration/deceleration, S-curve acceleration/deceleration	
Compensation function		Backlash compensation, Electronic gear, Near pass function	
Synchronous control		Synchronous encoder input, command generation axis, cam, phase compensation, cam auto-generation	
Cam control	Number of registered cams*1	Up to 128 cams	
	Cam data format	Stroke ratio data format, coordinate data format	
	Automatic generation of cam	Automatic generation of cam for rotary cutter	
Control unit		mm, inch, degree, pulse	
Number of positioning data		600 data (positioning data No. 1 to 600)/axis (Can be set with MELSOFT GX Works3 or a sequence program.)	
Backup		Parameters, positioning data, and block start data can be saved on flash ROM (battery-less backup)	
Home position return		Driver home position return method	
Positioning control	Linear control	Linear interpolation control (Up to 4 axes)*2 (Vector speed, Reference axis speed)	
	Fixed-pitch feed control	Fixed-pitch feed control (Up to 4 axes)	
	2-axis circular interpolation	Auxiliary point-specified circular interpolation, Central point-specified circular interpolation	
	Speed control	Speed control (Up to 4 axes)	
	Speed-position switching control	INC mode, ABS mode	
	Position-speed switching control	INC mode	
	Current value change	Positioning data, Start No. for a current value changing	
	NOP instruction	Provided	
	JUMP instruction	Unconditional JUMP, Conditional JUMP	
	LOOP, LEND	Provided	
	High-level positioning control	Block start, Condition start, Wait start, Simultaneous start, Repeated start	
Manual control	JOG operation	Provided	
	Inching operation	Provided	
	Manual pulse generator	Possible to connect 1 module (Incremental), Unit magnification (1 to 10000 times)	
Expansion control	Speed-torque control	Speed control without positioning loops, Torque control, Tightening & press-fit control	
Absolute position system		Made compatible by setting a battery to servo amplifier	
Synchronous encoder interface		Up to 4 channels (Total of the, via PLC CPU interface, and servo amplifier interface)	
Functions that limit control	Speed limit function	Speed limit value, JOG speed limit value	
	Torque limit function	Torque limit value same setting, torque limit value individual setting	
	Forced stop	Via buffer memory, Valid/Invalid setting	
	Software stroke limit function	Movable range check with current feed value, movable range check with machine feed value	
	Hardware stroke limit function	Provided	
Functions that change control details	Speed change function	Provided	
	Override function	1 to 300 [%]	
	Acceleration/deceleration time change function	Provided	
	Torque change function	Provided	
	Target position change function	Target position address and speed are changeable	
Other functions	M-code output function	Provided	
	Step function	Deceleration unit step, Data No. unit step	
	Skip function	Via PLC CPU, Via external command signal	
	Teaching function	Provided	
Parameter initialization function		Provided	
External input signal setting function		Via CPU, Via servo amplifier	

Item		Specifications	
		FX5-40SSC-G	FX5-80SSC-G
Mark detection function		Continuous Detection mode, Specified Number of Detections mode, Ring Buffer mode	
	Mark detection signal	Signals for the number of axes of the connected servo amplifiers	
	Mark detection setting	16 settings	
Optional data monitor function		Up to 4 points/axis	
Event history function		Provided	
Servo transient transmission function		Provided	
Digital oscilloscope function*3	Bit data	16 ch	
	Word data	16 ch	

*1: The number of registered cams varies depending on the memory capacity, cam resolution, and the number of coordinates.

*2: 4-axis linear interpolation control is enabled only at the reference axis speed.

*3: 8 ch word data and 8 ch bit data can be displayed in real time.

Module specification

Item		Specifications	
		FX5-40SSC-G	FX5-80SSC-G
Communication speed		1 Gbps	
Maximum number of connectable stations per network		Motion control stations: 4 Standard stations: 16	Motion control stations: 8 Standard stations: 16
Communication cable		Ethernet cable (Category 5e or higher, straight cable (double-shielded, STP))	
Maximum station-to-station distance		100 m	
Maximum number of networks		239	
Network topology*		Line topology, star topology (Coexistence of line topology and star topology is also possible.)	
Communication method		Time sharing method	
Transient transmission capacity		1920 bytes	
Maximum number of link points per network	RX/RX	8192 points, 1K bytes (When used as a master station)	
	RW/RWw	1024 points, 2K bytes (When used as a master station)	
Maximum number of link points per station	RX/RX	8192 points, 1K bytes (When used as a master station)	
	RW/RWw	1024 points, 2K bytes (When used as a master station)	
Compatible CPU module		FX5U, FX5UC: Ver. 1.230 or later Connection with FX5UC CPU module requires connector conversion module (FX5-CNV-IFC) or extension power supply module (FX5-C1PS-5V).	
Number of occupied input/output points		8 points (Either input or output is available for counting.)	
Power supply		24 V DC +20%/-15% (external power supply)	

*: Use a switching hub (certified class: B) for star topology.

External Dimensions

Unit: mm

CPU module

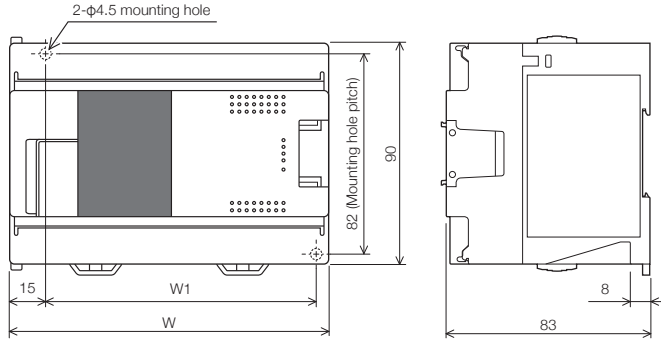

- External color: Main body, Munsell 0.6B7.6/0.2

Model	W: mm	W1: mm Mounting hole pitches	MASS (Weight): kg
FX5UJ-24M□	95	76	Approx. 0.55
FX5UJ-40M□	130	111	Approx. 0.65
FX5UJ-60M□	175	156	Approx. 0.80

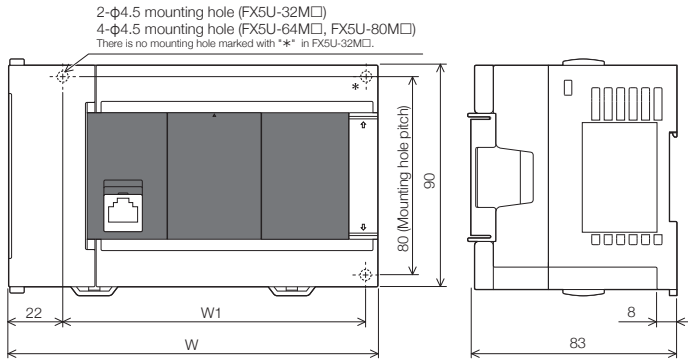

- External color: Main body, Munsell 0.6B7.6/0.2

Model	W: mm	W1: mm Mounting hole pitches	MASS (Weight): kg
FX5U-32MR/ES, FX5U-32MT/ES, FX5U-32MT/ESS FX5U-32MR/DS, FX5U-32MT/DS, FX5U-32MT/DSS	150	123	Approx. 0.7
FX5U-64MR/ES, FX5U-64MT/ES, FX5U-64MT/ESS FX5U-64MR/DS, FX5U-64MT/DS, FX5U-64MT/DSS	220	193	Approx. 1.0
FX5U-80MR/ES, FX5U-80MT/ES, FX5U-80MT/ESS FX5U-80MR/DS, FX5U-80MT/DS, FX5U-80MT/DSS	285	258	Approx. 1.2

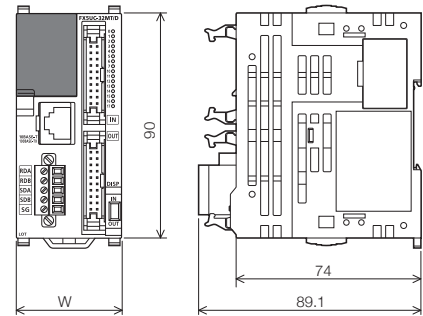

- External color: Main body, Munsell 0.6B7.6/0.2

- Accessories: FX2NC-100PCB type power cable
FX2NC-100BPCB type power cable (FX5UC-□MT/D only)

Model	W: mm	MASS (Weight): kg
FX5UC-32MT/D, FX5UC-32MT/DSS	42.1	Approx. 0.2
FX5UC-64MT/D, FX5UC-64MT/DSS	62.2	Approx. 0.3
FX5UC-96MT/D, FX5UC-96MT/DSS	82.3	Approx. 0.35

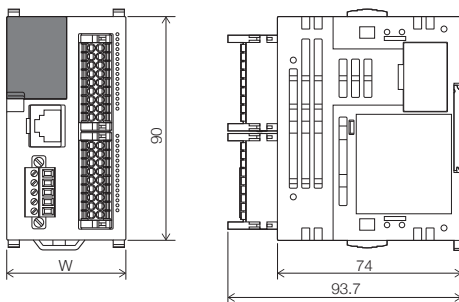

- External color: Main body, Munsell 0.6B7.6/0.2
- Accessories: FX2NC-100PCB type power cable

Model	W: mm	MASS (Weight): kg
FX5UC-32MT/DS-TS, FX5UC-32MT/DSS-TS	48.1	Approx. 0.25
FX5UC-32MR/DS-TS	68.2	Approx. 0.35

Unit: mm

Safety extension module

Safety main module

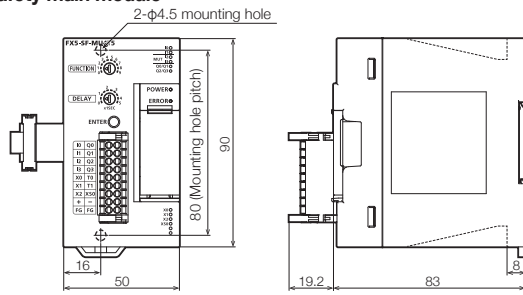

- External color: Munsell 0.6B7.6/0.2

Model	MASS (Weight): kg
FX5-SF-MU4T5	Approx. 0.3

Safety input expansion module

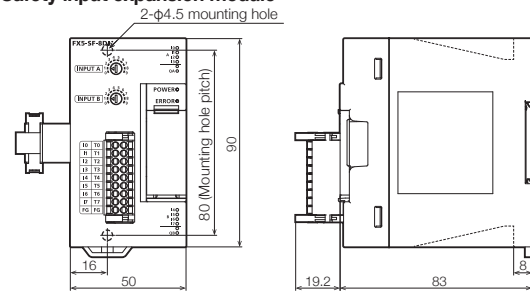

- External color: Munsell 0.6B7.6/0.2

Model	MASS (Weight): kg
FX5-SF-8D14	Approx. 0.25

External Dimensions

Unit: mm

I/O module

Input module/output module (extension cable type), high-speed pulse input/output module

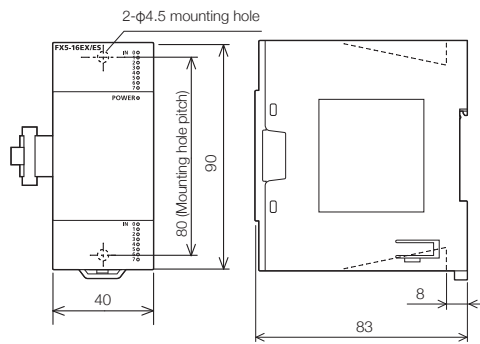

- External color: Munsell 0.6B7.6/0.2

Model	MASS (Weight): kg
FX5-8EX/ES, FX5-8EYR/ES, FX5-8EYT/ES, FX5-8EYT/ESS	Approx. 0.2
FX5-16EX/ES, FX5-16EYR/ES, FX5-16EYT/ES, FX5-16EYT/ESS, FX5-16ER/ES, FX5-16ET/ES, FX5-16ET/ESS, FX5-16ET/ES-H, FX5-16ET/ESS-H	Approx. 0.25

Powered input/output module

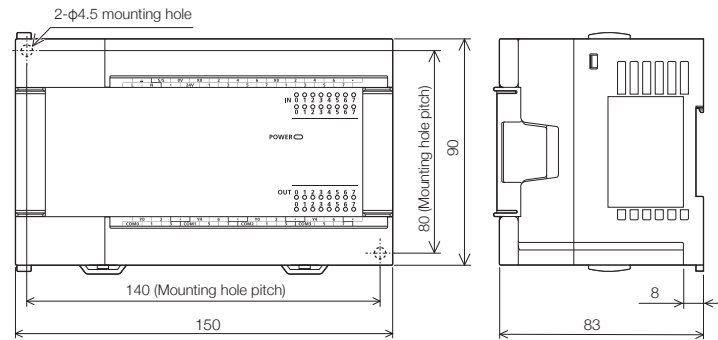

- External color: Munsell 0.6B7.6/0.2
- Accessories: Extension cable

Model	MASS (Weight): kg
FX5-32ER/ES, FX5-32ET/ES, FX5-32ET/ESS, FX5-32ER/DS, FX5-32ET/DS, FX5-32ET/DSS	Approx. 0.65

Input module/output module (extension connector type)

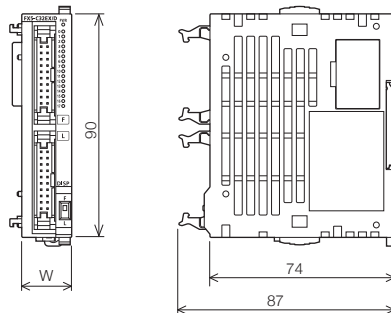

- External color: Munsell 0.6B7.6/0.2

Model	W: mm	MASS (Weight): kg
FX5-C16EX/D, FX5-C16EX/DS, FX5-C16EYT/D, FX5-C16EYT/DSS	14.6	Approx. 0.1
FX5-C32EX/D, FX5-C32EX/DS, FX5-C32EYT/D, FX5-C32EYT/DSS	20.1	Approx. 0.15

Input/output module (extension connector type)

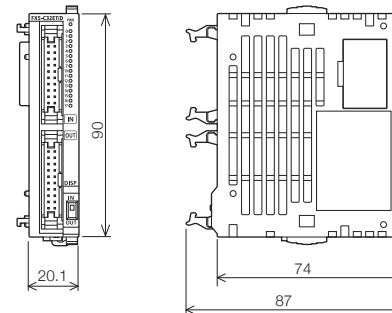

- External color: Munsell 0.6B7.6/0.2

Model	MASS (Weight): kg
FX5-C32ET/D, FX5-C32ET/DSS	Approx. 0.15

Input module/output module/Input/output module (Spring clamp terminal block type)

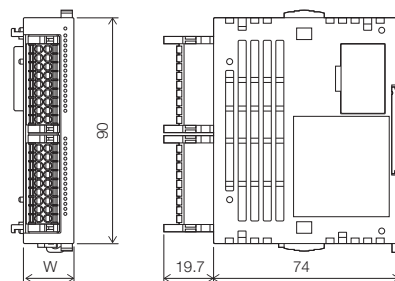

- External color: Main body, Munsell 0.6B7.6/0.2

Model	W: mm	MASS (Weight): kg
FX5-C16EYR/D-TS	30.7	Approx. 0.2
FX5-C32EX/DS-TS, FX5-C32EYT/D-TS, FX5-C32EYT/DSS-TS, FX5-C32ET/DS-TS, FX5-C32ET/DSS-TS	20.1	Approx. 0.15

Unit: mm

Intelligent function module

FX5-40SSC-S/FX5-80SSC-S FX5-40SSC-S/FX5-80SSC-S

- MASS (Weight): Approx. 0.3 kg
- External color: Munsell 0.6B7.6/0.2

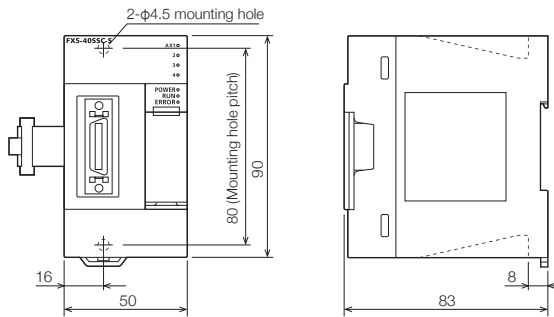

FX5-4AD/FX5-4DA

- MASS (Weight): Approx. 0.2 kg
- External color: Munsell 0.6B7.6/0.2

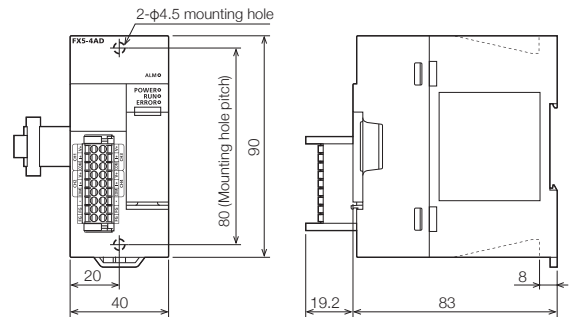

FX5-8AD

- MASS (Weight): Approx. 0.3 kg
- External color: Munsell 0.6B7.6/0.2

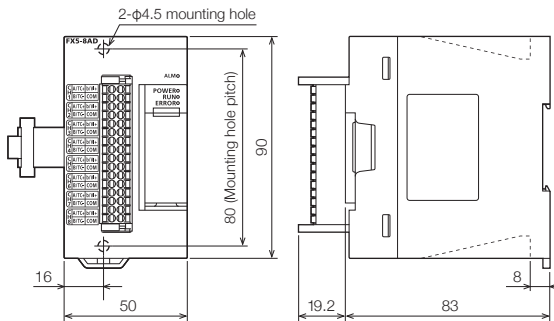

FX5-4LC

- MASS (Weight): Approx. 0.3 kg
- External color: Munsell 0.6B7.6/0.2

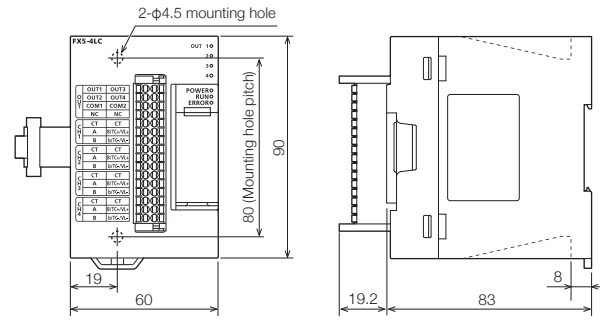

FX5-20PG-P/FX5-20PG-D

- MASS (Weight): Approx. 0.2 kg
- External color: Munsell 0.6B7.6/0.2

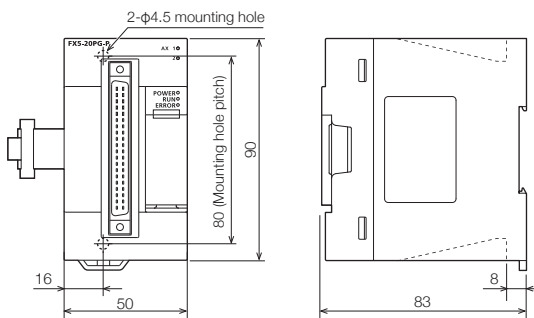

FX5-CCL-MS

- MASS (Weight): Approx. 0.3 kg
- External color: Munsell 0.6B7.6/0.2

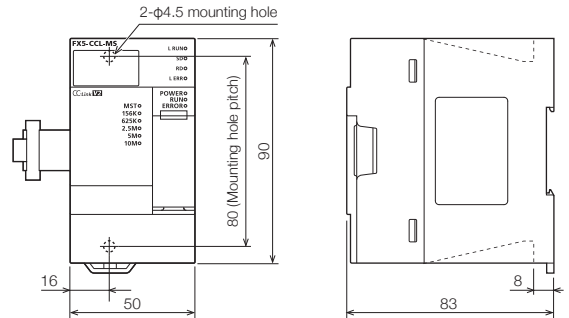

FX5-CCLIEF

- MASS (Weight): Approx. 0.3 kg
- External color: Munsell 0.6B7.6/0.2

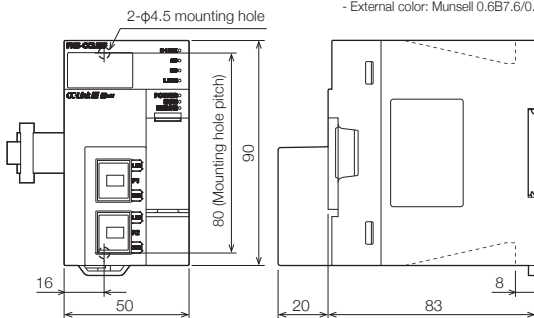

FX5-CCLGN-MS

- MASS (Weight): Approx. 0.3 kg
- External color: Munsell 0.6B7.6/0.2

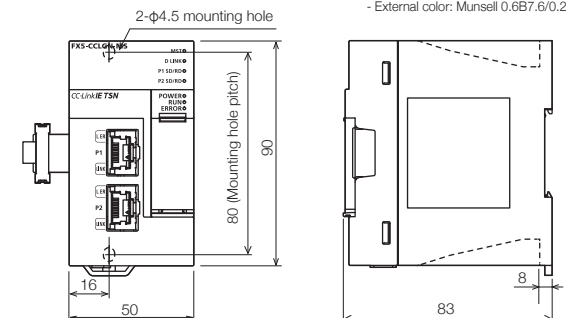

External Dimensions

Unit: mm

FX5-ASL-M

- MASS (Weight): Approx. 0.2 kg
- External color: Munsell 0.6B7.6/0.2

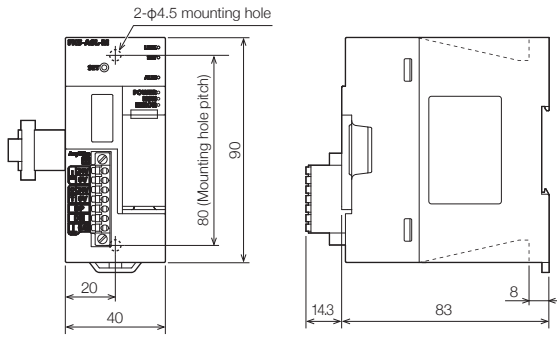

FX5-DP-M

- MASS (Weight): Approx. 0.2 kg
- External color: Munsell 0.6B7.6/0.2

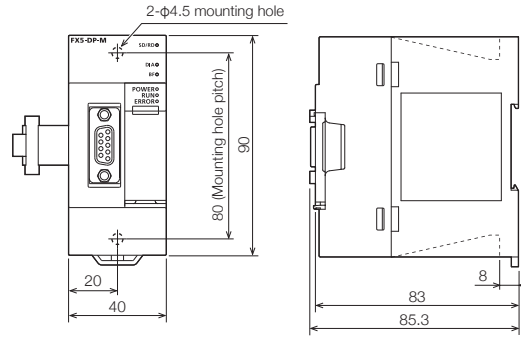

FX5-ENET

- MASS (Weight): Approx. 0.2 kg
- External color: Munsell 0.6B7.6/0.2

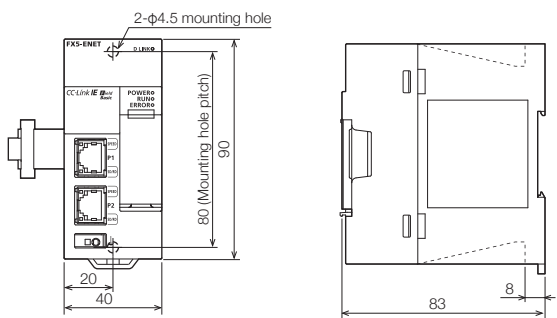

FX5-ENET/IP

- MASS (Weight): Approx. 0.2 kg
- External color: Munsell 0.6B7.6/0.2

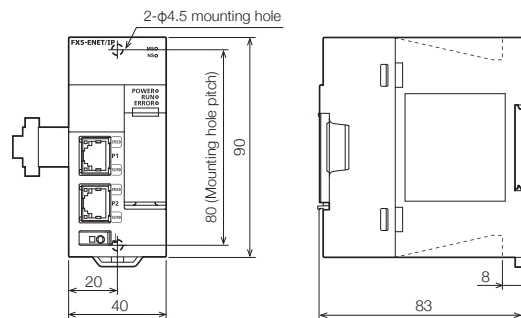

FX5-OPC

- MASS (Weight): Approx. 0.2 kg
- External color: Munsell 0.6B7.6/0.2

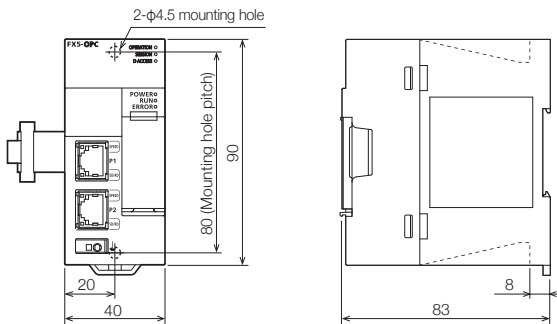

Expansion adapter

FX5-4A-ADP/FX5-4AD-ADP FX5-4DA-ADP/FX5-4AD-PT-ADP FX5-4AD-TC-ADP

- MASS (Weight): Approx. 0.1 kg
- External color: Munsell 0.6B7.6/0.2

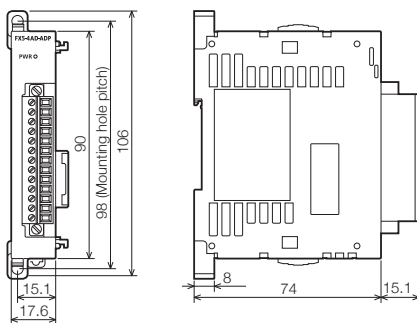

FX5-232ADP/FX5-485ADP

- MASS (Weight): Approx. 0.08 kg
- External color: Munsell 0.6B7.6/0.2

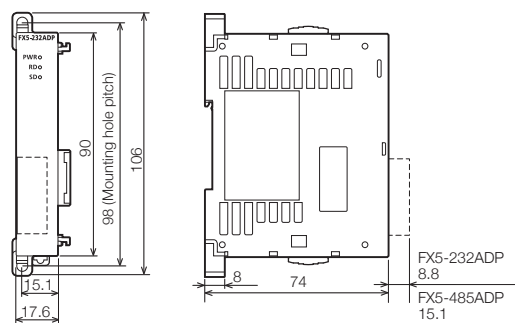

FX5-232ADP 8.8
FX5-485ADP 15.1

Unit: mm

Expansion board

FX5-232-BD

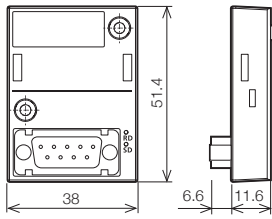

FX5-485-BD

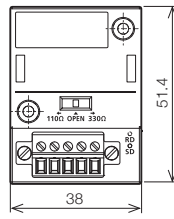

FX5-422-BD-GOT

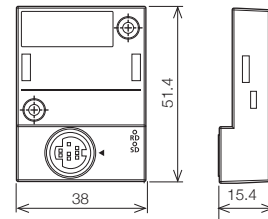

- MASS (Weight): Approx. 0.02 kg
- External color: Munsell N1.5

Bus conversion module

FX5-CNV-BUS

- MASS (Weight): Approx. 0.1 kg
- External color: Munsell 0.6B7.6/0.2

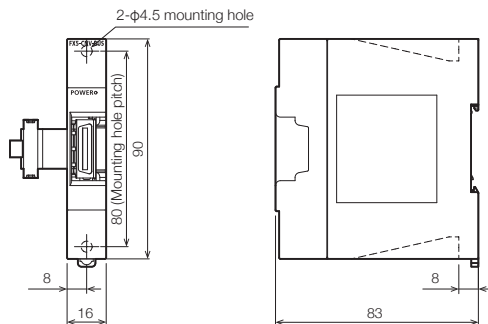

FX5-CNV-BUSC

- MASS (Weight): Approx. 0.1 kg
- External color: Munsell 0.6B7.6/0.2

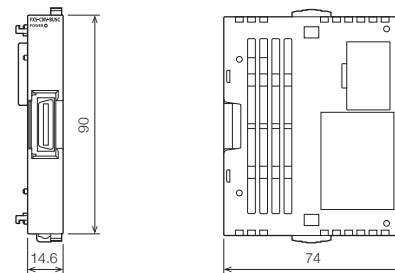

Connector conversion module

FX5-CNV-IF

- MASS (Weight): Approx. 0.06 kg
- External color: Munsell 0.6B7.6/0.2
- Accessory: Extension cable

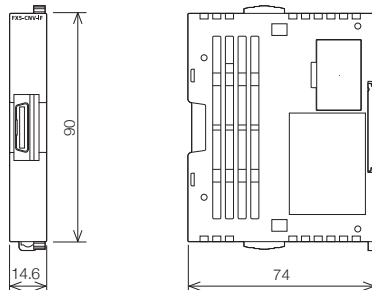

FX5-CNV-IFC

- MASS (Weight): Approx. 0.06 kg
- External color: Munsell 0.6B7.6/0.2

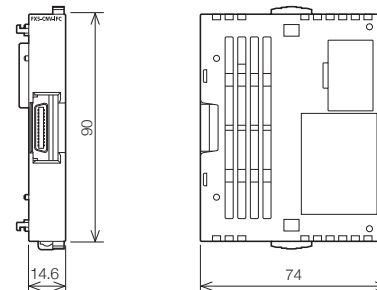

Connector conversion adapter

FX5-CNV-BC

- MASS (Weight): Approx. 0.04 kg
- External color: Munsell 0.08GY/7.64/0.81

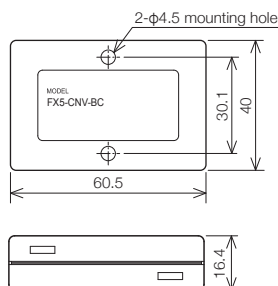

External Dimensions

Unit: mm

FX5 extension power supply module

FX5-1PSU-5V

- MASS (Weight): Approx. 0.3 kg
- External color: Munsell 0.6B7.6/0.2
- Accessories: Extension cable
- M3 terminal screw for terminal block
- DIN rail of 35 mm in width can be installed

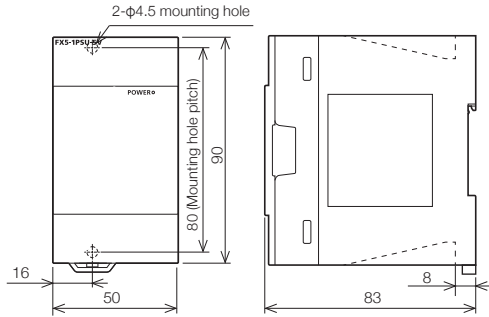

FX5-C1PS-5V

- MASS (Weight): Approx. 0.1 kg
- External color: Munsell 0.6B7.6/0.2

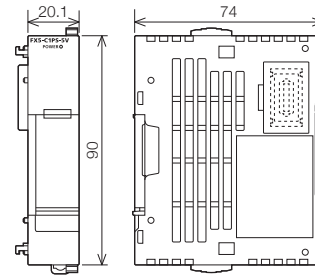

FX3 extension power supply module

FX3U-1PSU-5V

- MASS (Weight): Approx. 0.3 kg
- External color: Munsell 0.08GY/7.64/0.81
- Accessories: Extension cable
- M3 terminal screw for terminal block
- DIN rail of 35 mm in width can be installed

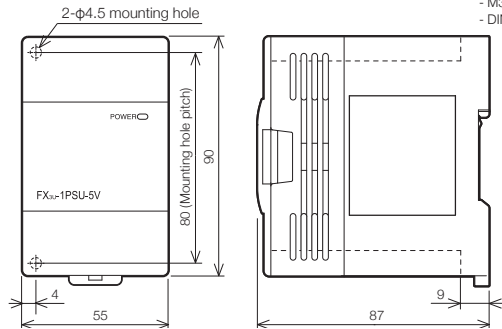

FX3 intelligent function module

FX3U-4AD/FX3U-4DA

FX3U-64CCL/FX3U-16CCL-M

- External color: Munsell 0.08GY/7.64/0.81
- Accessories: Special block No. label, dust sheet, and terminating resistor*
- M3 terminal screw for terminal block
- DIN rail of 35 mm in width can be installed
- *: Attached only to FX3U-16CCL-M

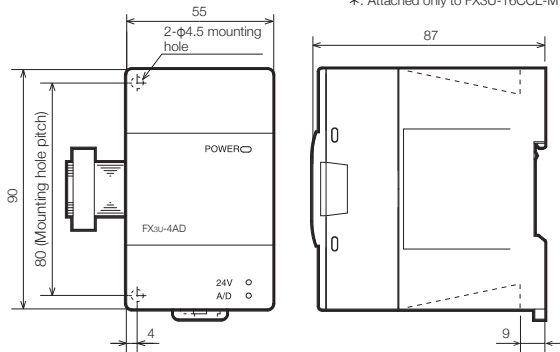

Model	MASS (Weight): kg
FX3U-4AD, FX3U-4DA	Approx. 0.2
FX3U-64CCL, FX3U-16CCL-M	Approx. 0.3

FX3U-4LC

- Mass (Weight): Approx. 0.4 kg
- External color: Munsell 0.08GY/7.64/0.81
- M3 terminal screw for terminal block
- DIN rail of 35 mm in width can be installed

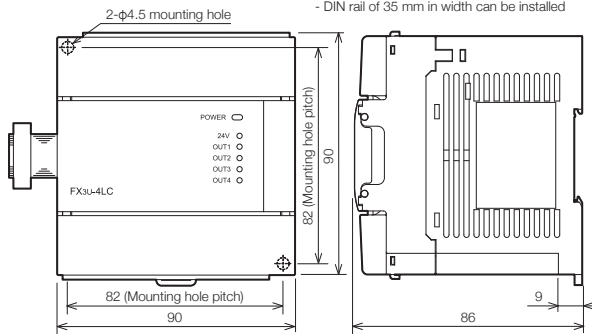

FX3U-2HC

- Mass (Weight): Approx. 0.2 kg
- External color: Munsell 0.08GY/7.64/0.81
- DIN rail of 35 mm in width can be installed

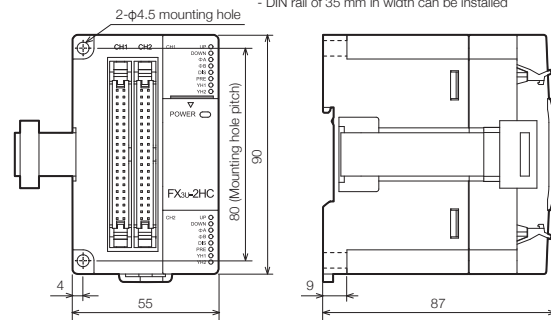

FX3U-1PG

- Mass (Weight): Approx. 0.2 kg
- External color: Munsell 0.08GY/7.64/0.81
- M3 terminal screw for terminal block
- DIN rail of 35 mm in width can be installed

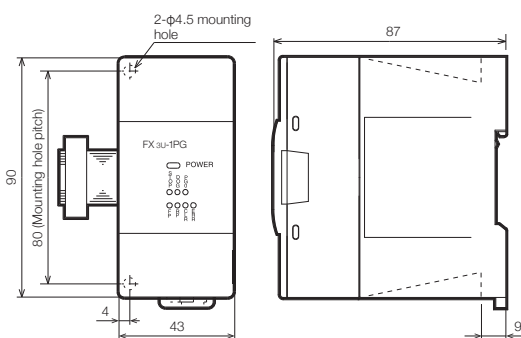

FX3U-128ASL-M

- Mass (Weight): Approx. 0.2 kg
- External color: Munsell 0.08GY/7.64/0.81
- DIN rail of 35 mm in width can be installed

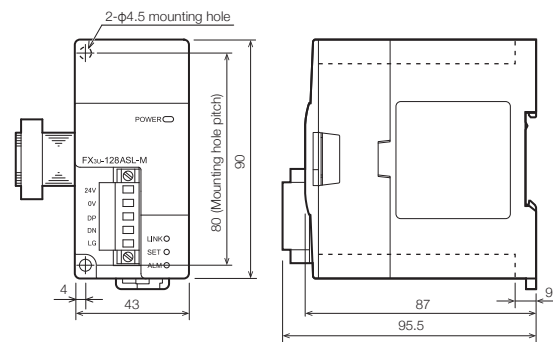

FX3U-32DP

- Mass (Weight): Approx. 0.2 kg
- External color: Munsell 0.08GY/7.64/0.81

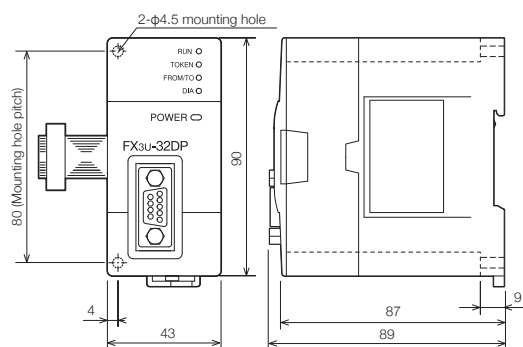

External Dimensions

Unit: mm

Terminal block (common to all models)

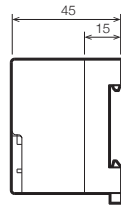
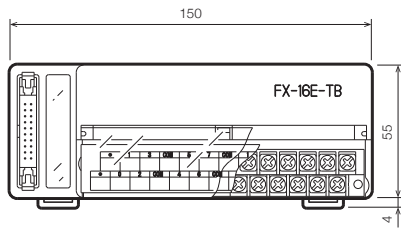

- External color: Munsell 0.08GY/7.64/0.81
- Accessory: Terminal block arrangement card
- M3.5 terminal screw for terminal block
- DIN rail of 35 mm in width can only be installed

Terminal Arrangement

FX5UJ CPU module

FX5UJ-24MR/ES, FX5UJ-24MT/ES

\perp	S/S	1	3	5	7	11	13	15
L	N	X0	2	4	6	X10	12	14
0V	Y0	2	Y3	5	Y6	10	•	
24V	COM0	1	COM1	4	COM2	7	11	

FX5UJ-24MT/ESS

0V	Y0	2	Y3	5	Y6	10	•
24V	+V0	1	+V1	4	+V2	7	11

FX5UJ-40MR/ES, FX5UJ-40MT/ES

\perp	S/S	1	3	5	7	11	13	15	17	21	23	25	27
L	N	X0	2	4	6	X10	12	14	16	20	22	24	26
0V	Y0	2	•	Y4	6	•	Y10	12	•	Y14	16	•	
24V	COM0	1	3	COM1	5	7	COM2	11	13	COM3	15	17	

FX5UJ-40MT/ESS

0V	Y0	2	•	Y4	6	•	Y10	12	•	Y14	16	•
24V	+V0	1	3	+V1	5	7	+V2	11	13	+V3	15	17

FX5UJ-60MR/ES, FX5UJ-60MT/ES

\perp	S/S	1	3	5	7	11	13	15	17	21	23	25	27	31	33	35	37	41	43
L	N	X0	2	4	6	X10	12	14	16	X20	22	24	26	X30	32	34	36	X40	42
0V	Y0	2	•	Y4	6	•	Y10	12	•	Y14	16	•	Y20	22	•	Y24	26	•	
24V	COM0	1	3	COM1	5	7	COM2	11	13	COM3	15	17	COM4	21	23	COM5	25	27	

FX5UJ-60MT/ESS

0V	Y0	2	•	Y4	6	•	Y10	12	•	Y14	16	•	Y20	22	•	Y24	26	•
24V	+V0	1	3	+V1	5	7	+V2	11	13	+V3	15	17	+V4	21	23	+V5	25	27

Terminal Arrangement

FX5U CPU module

FX5U-32MR/ES, FX5U-32MT/ES

⊥	S/S	0V	X0	2	4	6	X10	12	14	16	•
L	N	•	24V	1	3	5	7	11	13	15	17
Y0	2	•	Y4	6	•	Y10	12	•	Y14	16	•
COM0	1	3	COM1	5	7	COM2	11	13	COM3	15	17

FX5U-32MR/DS, FX5U-32MT/DS

⊥	S/S	•	X0	2	4	6	X10	12	14	16	•
⊕	⊖	•	•	1	3	5	7	11	13	15	17
Y0	2	•	Y4	6	•	Y10	12	•	Y14	16	•
COM0	1	3	COM1	5	7	COM2	11	13	COM3	15	17

FX5U-32MT/ESS

Y0	2	•	Y4	6	•	Y10	12	•	Y14	16	•
+V0	1	3	+V1	5	7	+V2	11	13	+V3	15	17

FX5U-32MT/DSS

Y0	2	•	Y4	6	•	Y10	12	•	Y14	16	•
+V0	1	3	+V1	5	7	+V2	11	13	+V3	15	17

FX5U-64MR/ES, FX5U-64MT/ES

⊥	S/S	0V	0V	X0	2	4	6	X10	12	14	16	X20	22	24	26	X30	32	34	36	•
L	N	•	24V	24V	1	3	5	7	11	13	15	17	21	23	25	27	31	33	35	37
Y0	2	•	Y4	6	•	Y10	12	•	Y14	16	•	Y20	22	24	26	Y30	32	34	36	COM5
COM0	1	3	COM1	5	7	COM2	11	13	COM3	15	17	COM4	21	23	25	27	31	33	35	37

FX5U-64MT/ESS

Y0	2	•	Y4	6	•	Y10	12	•	Y14	16	•	Y20	22	24	26	Y30	32	34	36	+V5
+V0	1	3	+V1	5	7	+V2	11	13	+V3	15	17	+V4	21	23	25	27	31	33	35	37

FX5U-64MR/DS, FX5U-64MT/DS

⊥	S/S	•	•	X0	2	4	6	X10	12	14	16	X20	22	24	26	X30	32	34	36	•
⊕	⊖	•	•	•	1	3	5	7	11	13	15	17	21	23	25	27	31	33	35	37
Y0	2	•	Y4	6	•	Y10	12	•	Y14	16	•	Y20	22	24	26	Y30	32	34	36	COM5
COM0	1	3	COM1	5	7	COM2	11	13	COM3	15	17	COM4	21	23	25	27	31	33	35	37

FX5U-64MT/DSS

Y0	2	•	Y4	6	•	Y10	12	•	Y14	16	•	Y20	22	24	26	Y30	32	34	36	+V5
+V0	1	3	+V1	5	7	+V2	11	13	+V3	15	17	+V4	21	23	25	27	31	33	35	37

FX5U CPU module

FX5U-80MR/ES, FX5U-80MT/ES

$\frac{\perp}{\perp}$	S/S	0V	0V	X0	2	4	6	X10	12	14	16					X20	22	24	26			X30	32	34	36			X40	42	44	46				
L	N	•	24V	24V	1	3	5	7	11	13	15				17	•	21	23	25	27	•	31	33	35	37	•	41	43	45	47					
Y0	2	•	Y4	6	•	Y10	12	•	Y14	16	•	Y20	22	24	26																				
COM0	1	3	COM1	5	7	COM2	11	13	COM3	15	17	COM4	21	23	25							27	•	COM5	31	33	35	37	COM6	41	43	45	47		

FX5U-80MT/ESS

Y0	2	•	Y4	6	•	Y10	12	•	Y14	16	•	Y20	22	24	26																				
+V0	1	3	+V1	5	7	+V2	11	13	+V3	15	17	+V4	21	23	25							27	•	+V5	31	33	35	37	+V6	41	43	45	47		

FX5U-80MR/DS, FX5U-80MT/DS

$\frac{\perp}{\perp}$	S/S	•	•	X0	2	4	6	X10	12	14	16					X20	22	24	26			X30	32	34	36			X40	42	44	46				
⊕	⊖	•	•	•	1	3	5	7	11	13	15				17	•	21	23	25	27	•	31	33	35	37	•	41	43	45	47					
Y0	2	•	Y4	6	•	Y10	12	•	Y14	16	•	Y20	22	24	26																				
COM0	1	3	COM1	5	7	COM2	11	13	COM3	15	17	COM4	21	23	25							27	•	COM5	31	33	35	37	COM6	41	43	45	47		

FX5U-80MT/DSS

Y0	2	•	Y4	6	•	Y10	12	•	Y14	16	•	Y20	22	24	26																				
+V0	1	3	+V1	5	7	+V2	11	13	+V3	15	17	+V4	21	23	25							27	•	+V5	31	33	35	37	+V6	41	43	45	47		

Terminal Arrangement

FX5UC CPU module

FX5UC-32MT/D

Input	
X0	X10
X1	X11
X2	X12
X3	X13
X4	X14
X5	X15
X6	X16
X7	X17
COM	COM
.	.
Output	
Y0	Y10
Y1	Y11
Y2	Y12
Y3	Y13
Y4	Y14
Y5	Y15
Y6	Y16
Y7	Y17
COM0	COM0
.	.

FX5UC-32MT/DSS

Input	
X0	X10
X1	X11
X2	X12
X3	X13
X4	X14
X5	X15
X6	X16
X7	X17
COM0	COM0
.	.
Output	
Y0	Y10
Y1	Y11
Y2	Y12
Y3	Y13
Y4	Y14
Y5	Y15
Y6	Y16
Y7	Y17
+V0	+V0
.	.

FX5UC-32MT/DS-TS

Input	
X0	X10
X1	X11
X2	X12
X3	X13
X4	X14
X5	X15
X6	X16
X7	X17
S/S	S/S
Output	
Y0	Y10
Y1	Y11
Y2	Y12
Y3	Y13
Y4	Y14
Y5	Y15
Y6	Y16
Y7	Y17
COM0	COM0

FX5UC-32MT/DSS-TS

Input	
X0	X10
X1	X11
X2	X12
X3	X13
X4	X14
X5	X15
X6	X16
X7	X17
S/S	S/S
Output	
Y0	Y10
Y1	Y11
Y2	Y12
Y3	Y13
Y4	Y14
Y5	Y15
Y6	Y16
Y7	Y17
+V0	+V0

FX5UC-32MR/DS-TS

Input*	
X0	X0
X1	X1
X2	X2
X3	X3
X4	X4
X5	X5
X6	X6
X7	X7
S/S0	S/S0
Input*	
X10	X10
X11	X11
X12	X12
X13	X13
X14	X14
X15	X15
X16	X16
X17	X17
S/S1	S/S1
Output*	
Y0	Y0
Y1	Y1
Y2	Y2
Y3	Y3
Y4	Y4
Y5	Y5
Y6	Y6
Y7	Y7
COM0	COM0
Output*	
Y10	Y10
Y11	Y11
Y12	Y12
Y13	Y13
Y14	Y14
Y15	Y15
Y16	Y16
Y17	Y17
COM1	COM1

FX5UC-64MT/D

Input	
X0	X10
X1	X11
X2	X12
X3	X13
X4	X14
X5	X15
X6	X16
X7	X17
COM	COM
.	.
Input	
X20	X30
X21	X31
X22	X32
X23	X33
X24	X34
X25	X35
X26	X36
X27	X37
COM	COM
.	.
Output	
Y0	Y10
Y1	Y11
Y2	Y12
Y3	Y13
Y4	Y14
Y5	Y15
Y6	Y16
Y7	Y17
COM0	COM0
.	.
Output	
Y20	Y30
Y21	Y31
Y22	Y32
Y23	Y33
Y24	Y34
Y25	Y35
Y26	Y36
Y27	Y37
COM1	COM1
.	.

FX5UC-64MT/DSS

Input	
X0	X10
X1	X11
X2	X12
X3	X13
X4	X14
X5	X15
X6	X16
X7	X17
COM0	COM0
.	.
Input	
X20	X30
X21	X31
X22	X32
X23	X33
X24	X34
X25	X35
X26	X36
X27	X37
COM1	COM1
.	.
Output	
Y0	Y10
Y1	Y11
Y2	Y12
Y3	Y13
Y4	Y14
Y5	Y15
Y6	Y16
Y7	Y17
+V0	+V0
.	.
Output	
Y20	Y30
Y21	Y31
Y22	Y32
Y23	Y33
Y24	Y34
Y25	Y35
Y26	Y36
Y27	Y37
+V1	+V1
.	.

*: Terminals with the same name (such as X0 and X0) are connected inside the PLC.

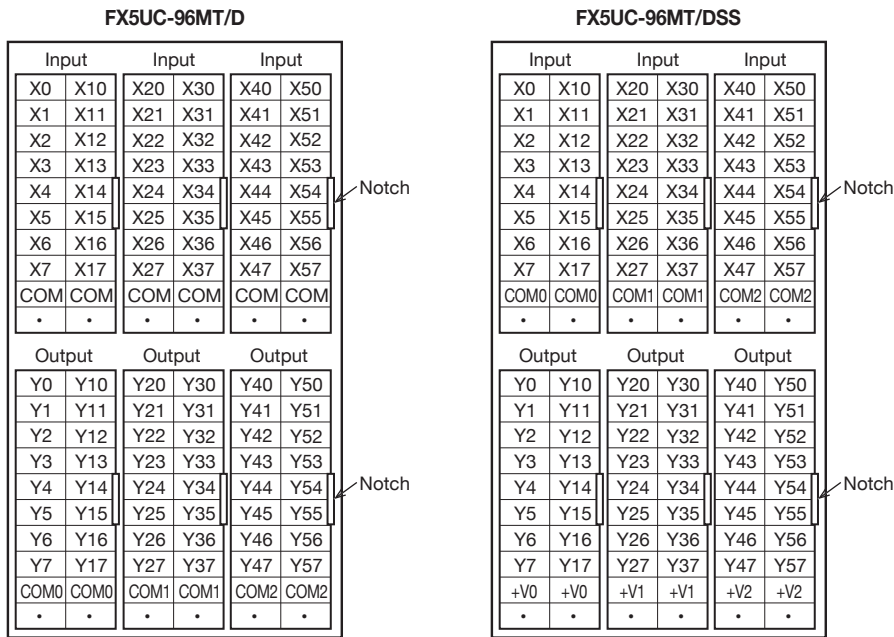

Safety extension module

FX5-SF-MU4T5

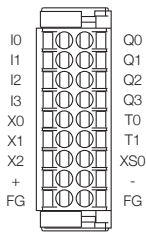

Left side of terminal arrangement		Right side of terminal arrangement	
Name	Description	Name	Description
I0	Safety input 0	Q0	Safety output 0
I1	Safety input 1	Q1	Safety output 1
I2	Safety input 2	Q2	Safety output 2
I3	Safety input 3	Q3	Safety output 3
X0	General input 0	T0	Test output 0
X1	General input 1	T1	Test output 1
X2	General input 2	XS0	ENABLE input
+	External 24 V +24 V terminal	-	External 24 V Ground terminal
FG	Frame ground	FG	Frame ground

FX5-SF-8DI4

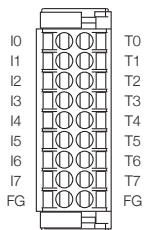

Left side of terminal arrangement		Right side of terminal arrangement	
Name	Description	Name	Description
I0	Safety input 0	T0	Test output 0
I1	Safety input 1	T1	Test output 1
I2	Safety input 2	T2	Test output 2
I3	Safety input 3	T3	Test output 3
I4	Safety input 4	T4	Test output 4
I5	Safety input 5	T5	Test output 5
I6	Safety input 6	T6	Test output 6
I7	Safety input 7	T7	Test output 7
FG	Frame ground	FG	Frame ground

I/O module

◇ Input module/output module (extension cable type)

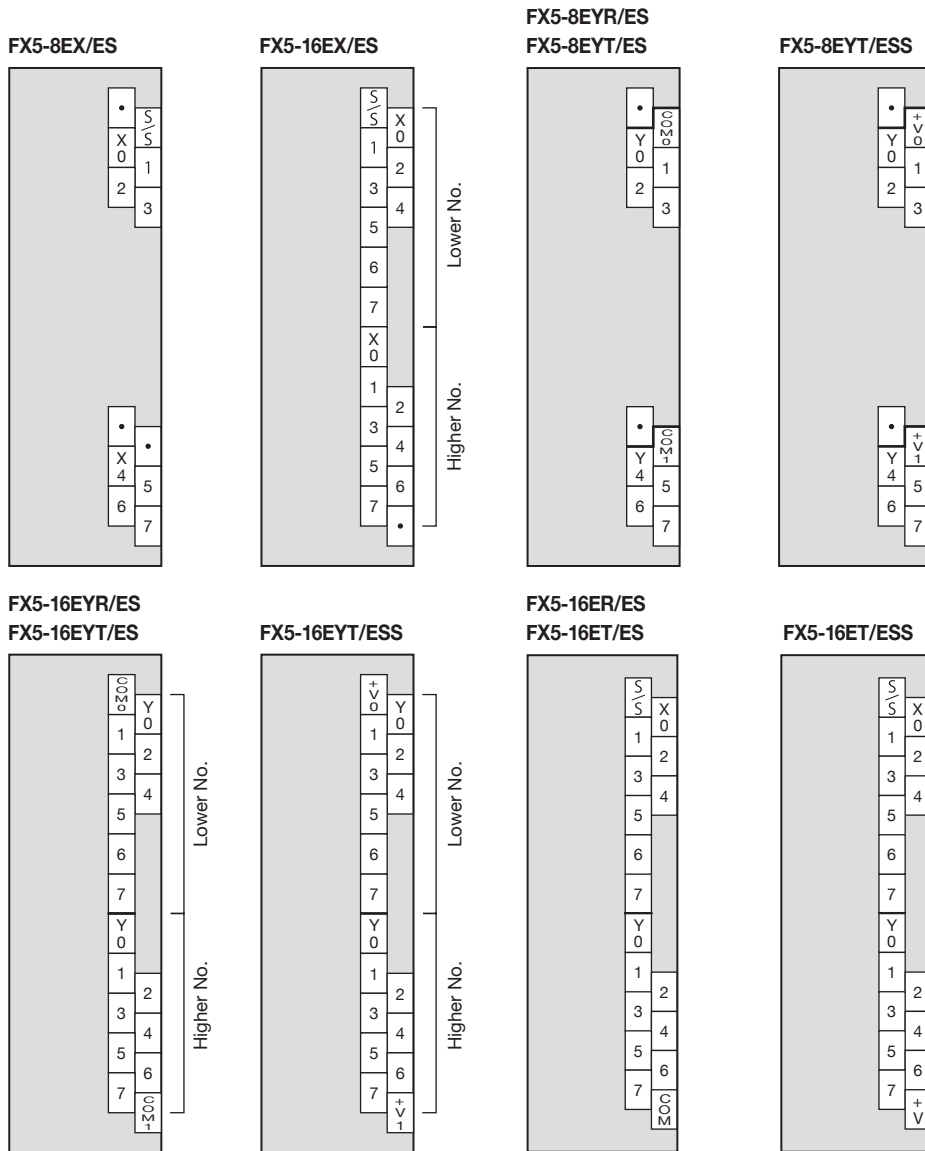

◇ High-speed pulse input/output module

FX5-16ET/ES-H

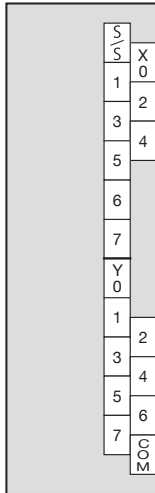

FX5-16ET/ESS-H

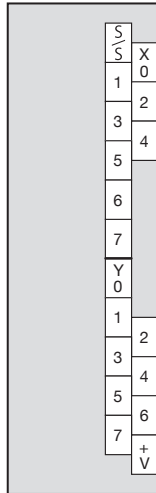

◇ Powered input/output modules

FX5-32ER/ES, FX5-32ET/ES

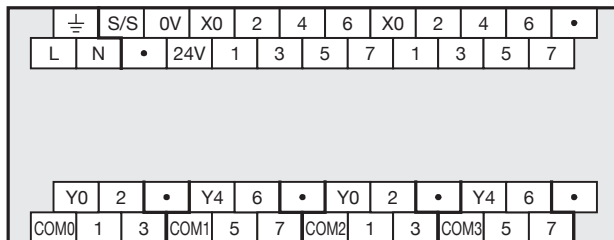

FX5-32ER/DS, FX5-32ET/DS

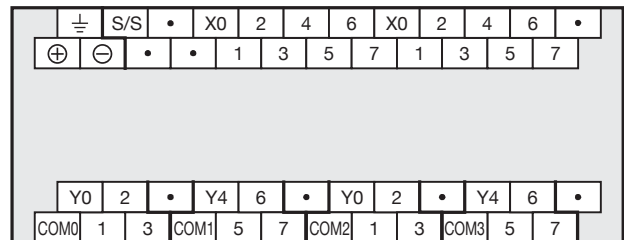

FX5-32ET/ESS

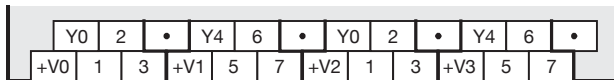

FX5-32ET/DSS

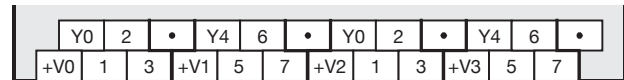

I/O module

◇ Input module/output module (extension connector type)

FX5-C16EX/D

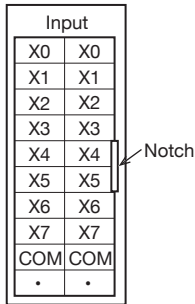

FX5-C16EX/DS

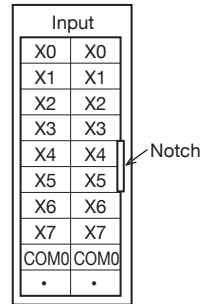

FX5-C32EX/D

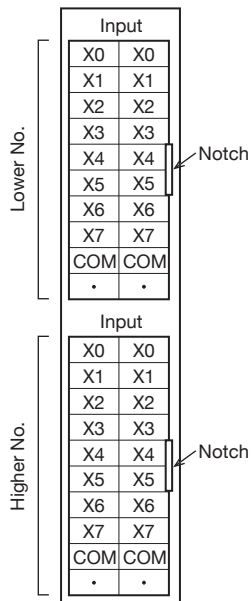

FX5-C32EX/DS

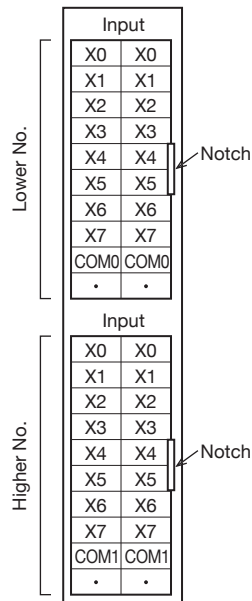

FX5-C32EX/DS-TS

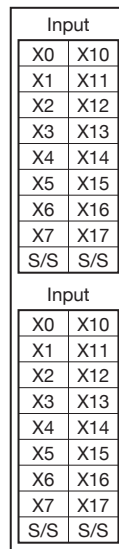

FX5-C16EYT/D

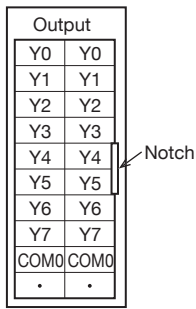

FX5-C16EYT/DSS

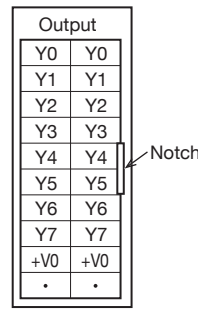

FX5-C32EYT/D

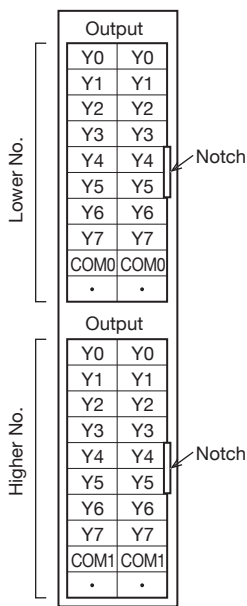

FX5-C32EYT/D-TS

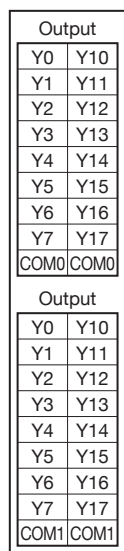

FX5-C32EYT/DSS

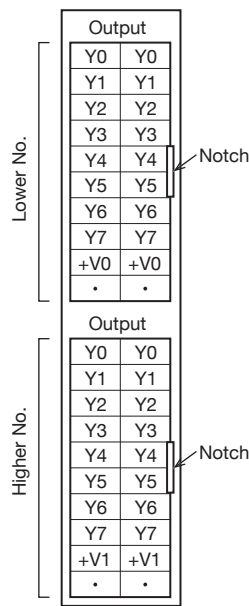

FX5-C32EYT/DSS-TS

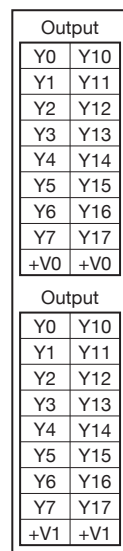

FX5-C16EYR/D-TS

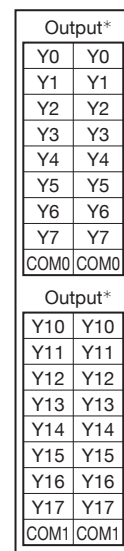

*: Terminals with the same name (such as Y0 and Y0) are connected inside the PLC.

Terminal Arrangement

◇ I/O module (extension connector type)

FX5-C32ET/D

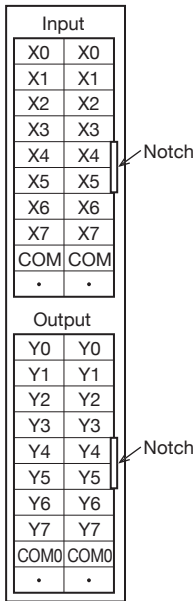

FX5-C32ET/DS-TS

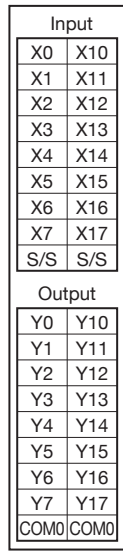

FX5-C32ET/DSS

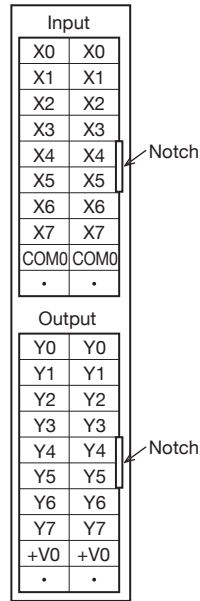

FX5-C32ET/DSS-TS

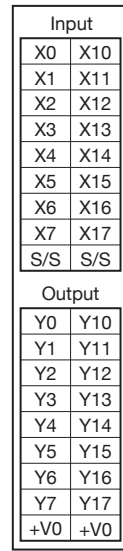

FX5 intelligent function module

FX5-4AD

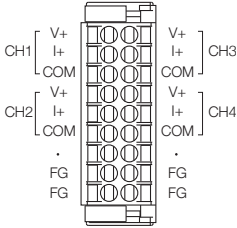

FX5-4DA

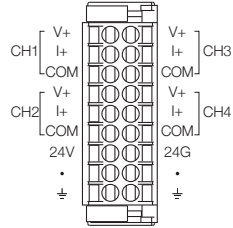

FX5-8AD

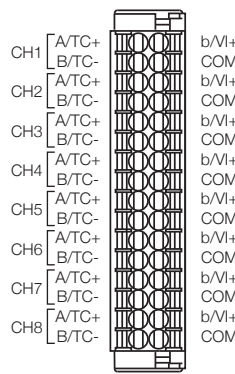

FX5-4LC

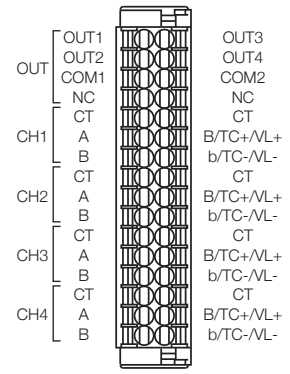

FX5-20PG-P

		Axis 2 (AX2)		Axis 1 (AX1)	
Pin No.	Signal name	Pin No.	Signal name	Pin No.	Signal name
B20		A20	PULSER B-	A20	PULSER B+
B19		A19	PULSER A-	A19	PULSER A+
B18		A18	PULSE COM	A18	PULSE COM
B17		A17	PULSE R	A17	PULSE R
B16		A16	PULSE COM	A16	PULSE COM
B15		A15	PULSE F	A15	PULSE F
B14		A14	CLRCOM	A14	CLRCOM
B13		A13	CLEAR	A13	CLEAR
B12		A12	RDYCOM	A12	RDYCOM
B11		A11	READY	A11	READY
B10		A10	PG0COM	A10	PG0COM
B9		A9	PG05	A9	PG05
B8		A8	PG024	A8	PG024
B7		A7	COM	A7	COM
B6		A6	COM	A6	COM
B5		A5	CHG	A5	CHG
B4		A4	STOP	A4	STOP
B3		A3	DOG	A3	DOG
B2		A2	RLS	A2	RLS
B1		A1	FLS	A1	FLS

FX5-20PG-D

		Axis 2 (AX2)		Axis 1 (AX1)	
Pin No.	Signal name	Pin No.	Signal name	Pin No.	Signal name
B20		A20	PULSER B-	A20	PULSER B+
B19		A19	PULSER A-	A19	PULSER A+
B18		A18	PULSE R-	A18	PULSE R-
B17		A17	PULSE R+	A17	PULSE R+
B16		A16	PULSE F-	A16	PULSE F-
B15		A15	PULSE F+	A15	PULSE F+
B14		A14	CLRCOM	A14	CLRCOM
B13		A13	CLEAR	A13	CLEAR
B12		A12	RDYCOM	A12	RDYCOM
B11		A11	READY	A11	READY
B10		A10	PG0COM	A10	PG0COM
B9		A9	PG05	A9	PG05
B8		A8	PG024	A8	PG024
B7		A7	COM	A7	COM
B6		A6	COM	A6	COM
B5		A5	CHG	A5	CHG
B4		A4	STOP	A4	STOP
B3		A3	DOG	A3	DOG
B2		A2	RLS	A2	RLS
B1		A1	FLS	A1	FLS

FX5-40SSC-S, FX5-80SSC-S

FX5-40SSC-G, FX5-80SSC-G

Pin No.	Signal name	Pin No.	Signal name
1	No connect	14	No connect
2	SG	15	SG
3	HA	16	HB
4	HAH	17	HBH
5	HAL	18	HBL
6 to 9	No connect	19 to 22	No connect
10	EMI	23	EMI.COM
11	DI1	24	DI2
12	DI3	25	DI4
13	COM	26	COM

FX5-ENET, FX5-ENET/IP, FX5-OPC

Pin No.	Signal name	Description
1	TP0+	Data 0 transmission/reception (positive side)
2	TP0-	Data 0 transmission/reception (negative side)
3	TP1+	Data 1 transmission/reception (positive side)
4	TP2+	Data 2 transmission/reception (positive side)
5	TP2-	Data 2 transmission/reception (negative side)
6	TP1-	Data 1 transmission/reception (negative side)
7	TP3+	Data 3 transmission/reception (positive side)
8	TP3-	Data 3 transmission/reception (negative side)

Terminal Arrangement

FX5-CCL-MS

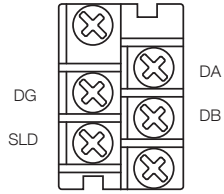

FX5-CCLIEF, FX5-CCLGN-MS

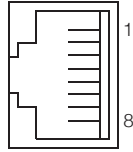

Pin No.	Signal name	Description
1	TP0+	Data 0 transmission/reception (positive side)
2	TP0-	Data 0 transmission/reception (negative side)
3	TP1+	Data 1 transmission/reception (positive side)
4	TP2+	Data 2 transmission/reception (positive side)
5	TP2-	Data 2 transmission/reception (negative side)
6	TP1-	Data 1 transmission/reception (negative side)
7	TP3+	Data 3 transmission/reception (positive side)
8	TP3-	Data 3 transmission/reception (negative side)

FX5-ASL-M

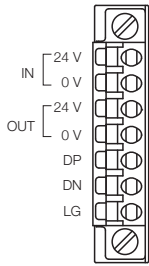

FX5-DP-M

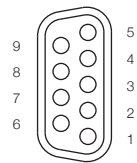

Pin No.	Signal name	Description
1	NC	Not connected
2	NC	Not connected
3	RxD/TxD-P	Receive/send data-P
4	CNTR-P*1	Control signal of repeaters
5	DGND*2	Data ground
6	VP*2	Voltage+
7	NC	Not connected
8	RxD/TxD-N	Receive/send data-N
9	NC	Not connected

*1: Optional signal
*2: Signal used for connecting a bus terminator

Expansion adapter

FX5-4A-ADP

V1+
I1+
COM1
V2+
I2+
COM2
•
V3+
I3+
COM3
V4+
I4+
COM4

FX5-4AD-ADP

V1+
I1+
COM1
V2+
I2+
COM2
V3+
I3+
COM3
V4+
I4+
COM4
⏏

FX5-4DA-ADP

V1+
I1+
COM1
V2+
I2+
COM2
V3+
I3+
COM3
V4+
I4+
COM4
•

FX5-4AD-PT-ADP

L1+
L1-
I1-
L2+
L2-
I2-
L3+
L3-
I3-
L4+
L4-
•

FX5-4AD-TC-ADP

•
L1+
L1-
•
L2+
L2-
•
L3+
L3-
•
L4+
L4-
•

FX5-232ADP

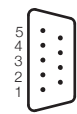

Pin No.	Signal
1	CD (CCD)
2	RD (RXD)
3	SD (TXD)
4	ER (DTR)
5	SG (GND)
6	DR (DSR)
7, 8, 9	Not used

9-pin D-SUB (male)
Mounting screw:
1/4 inch thread

FX5-485ADP

5 poles

Ⓜ	RDA (RXD+)
Ⓜ	RDB (RXD-)
Ⓜ	SDA (TXD+)
Ⓜ	SDB (TXD-)
Ⓜ	SG (GND)

Expansion board

FX5-232-BD

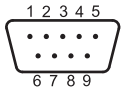

Pin No.	Signal
1	CD (DCD)
2	RD (RXD)
3	SD (TXD)
4	ER (DTR)
5	SG (GND)
6	DR (DSR)
7, 8, 9	Not used

9-pin D-SUB (male)
Mounting screw:
Inch thread

FX5-485-BD

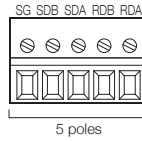

Signal Name
RDA (RXD+)
RDB (RXD-)
SDA (TXD+)
SDB (TXD-)
SG (GND)

FX5-422-BD-GOT



8-pin MINI-DIN (female)

FX5 extension power supply module

FX5-1PSU-5V



FX5-C1PS-5V



FX3U-1PSU-5V



FX3 intelligent function module

FX3U-4AD



FX3U-4DA



FX3U-4LC

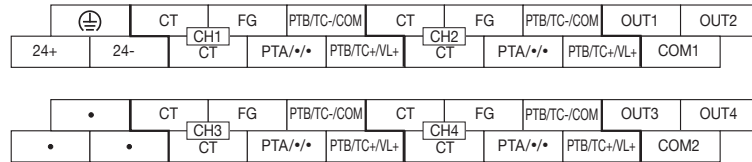

FX3U-2HC

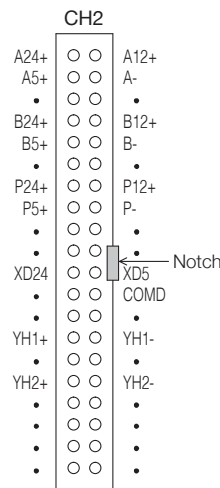
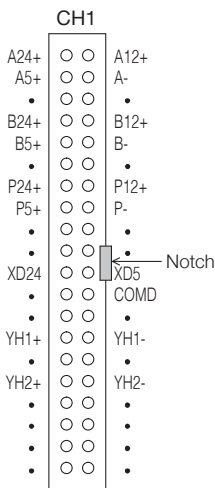

FX3U-1PG

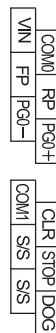

FX3U-64CCL



FX3U-16CCL-M



FX3U-128ASL-M

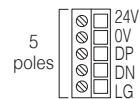

FX3U-32DP

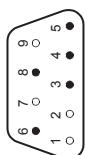

● Assigned
○ Not assigned

Pin No.	Signal name	Description
3	FXD/TXD-P	Receive/send data-P
4	RTS	Ready to send
5	DGND	Data ground
6	VP	Voltage+
8	FXD/TXD-N	Receive/send data-N
1, 2, 7, 9	NC	Not assigned

Terminal Arrangement

◇ Type system (CPU module, input/output extension device)

(1)	CPU category	FX5UJ, FX5U, FX5UC, etc.		Model system			
(2)	Type category	C (Extension connector type) None (Extension cable type)		<div style="font-size: 2em; font-weight: bold; margin-bottom: 10px;"> FX5 - C 32 M R /ES - □ </div> <div style="display: flex; justify-content: space-around; font-weight: bold;"> (1) (2) (3) (4) (5) (6) (7) </div>			
(3)	Total number of input/output points	8, 16, 24, 32, 40, 60, 64, 80, 96, etc.					
(4)	Module category	M	CPU module				
		E	Extension devices including both input and output devices				
		EY	Output extension module				
(5)	Output type	R	Relay output				
		T	Transistor output				
(6)	Power supply, input/output system			CPU module, extension module		Input/output extension module	
		Symbol	Power supply	Input type	Transistor output type	Input type	Transistor output type
		/ES	AC	24 V DC, sink/source	sink	sink/source	—
		/ESS	AC	24 V DC, sink/source	source	—	source
		/DS	DC	24 V DC, sink/source	sink	sink/source	—
		/DSS	DC	24 V DC, sink/source	source	—	source
(7)	Other suffix symbols	-H	High-speed input/output function expansion				
		-TS	Spring clamp terminal block				

◇ Input signal format

- When a contactless sensor output is connected to PLC, PNP open collector transistor output can be handled via source input wiring, and NPN open collector transistor output via sink input wiring.
- S/S terminal and 0 V terminal are short-circuited by source input wiring. (Left side of the drawing below)
S/S terminal and 24 V terminal are short-circuited by sink input wiring. (Right side of the drawing below)

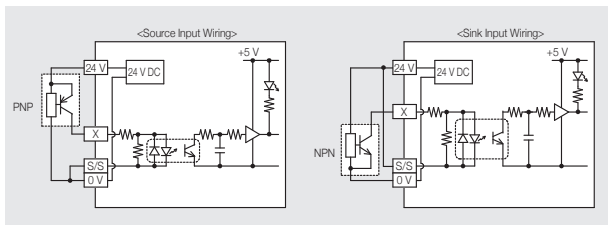

◇ Output signal format

- Relay output type is mechanically insulated by a relay, while transistor output type is insulated by a photocoupler. In addition, LED for output indication is driven by internal power supply.
- Transistor output is made up of NPN open collector output (sink [-common]) system and NPN emitter follower output (source [+common]) system.

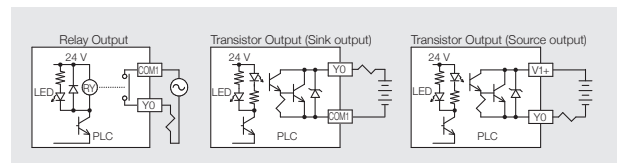

Products List

◇ CPU module

Model	Specifications				Description page	
	Rated voltage	Input	Output			
◆ FX5UJ CPU modules						
FX5UJ-24MR/ES	100 to 240 V AC 50/60 Hz	14 points	24 V DC sink/source	10 points	Relay	66
FX5UJ-24MT/ES					Transistor/sink	66
FX5UJ-24MT/ESS					Transistor/source	66
FX5UJ-40MR/ES		24 points		16 points	Relay	66
FX5UJ-40MT/ES					Transistor/sink	66
FX5UJ-40MT/ESS					Transistor/source	66
FX5UJ-60MR/ES		36 points		24 points	Relay	66
FX5UJ-60MT/ES					Transistor/sink	66
FX5UJ-60MT/ESS					Transistor/source	66
◆ FX5U CPU modules						
FX5U-32MR/ES	100 to 240 V AC 50/60 Hz	16 points	24 V DC sink/source	16 points	Relay	72
FX5U-32MT/ES					Transistor/sink	72
FX5U-32MT/ESS					Transistor/source	72
FX5U-64MR/ES		32 points		32 points	Relay	72
FX5U-64MT/ES					Transistor/sink	72
FX5U-64MT/ESS					Transistor/source	72
FX5U-80MR/ES		40 points		40 points	Relay	72
FX5U-80MT/ES					Transistor/sink	72
FX5U-80MT/ESS					Transistor/source	72
FX5U-32MR/DS		24 V DC		16 points	24 V DC sink/source	16 points
FX5U-32MT/DS	Transistor/sink		73			
FX5U-32MT/DSS	Transistor/source		73			
FX5U-64MR/DS	32 points		32 points	Relay		73
FX5U-64MT/DS				Transistor/sink		73
FX5U-64MT/DSS				Transistor/source		73
FX5U-80MR/DS	40 points		40 points	Relay		73
FX5U-80MT/DS				Transistor/sink		73
FX5U-80MT/DSS				Transistor/source		73
◆ FX5UC CPU modules						
FX5UC-32MT/D	24 V DC	16 points	24 V DC sink	16 points	Transistor/sink	81
FX5UC-32MT/DSS			24 V DC sink/source		Transistor/source	81
FX5UC-32MT/DS-TS			24 V DC sink/source		Transistor/sink	81
FX5UC-32MT/DSS-TS			24 V DC sink/source		Transistor/source	81
FX5UC-32MR/DS-TS		16 points	16 points	Relay	81	
FX5UC-64MT/D		32 points	32 points	24 V DC sink	Transistor/sink	81
FX5UC-64MT/DSS				24 V DC sink/source	Transistor/source	81
FX5UC-96MT/D				48 points	48 points	24 V DC sink
FX5UC-96MT/DSS		24 V DC sink/source	Transistor/source			81

◇ Safety extension module

Model	Specifications	Description page
FX5-SF-MU4T5	Safety main module 4-points safety input/4-points safety output	88
FX5-SF-8D4	Safety input expansion module 8-points safety input	89

Products List

◇ I/O module

Model	Specifications					Description page	
	Rated voltage	Input	Output				
■■■ Extension cable type ■■■							
◆ Input module							
FX5-8EX/ES	Supplied from CPU module	8 points	24 V DC sink/source	—	—	92	
FX5-16EX/ES		16 points		—	—	92	
◆ Output module							
FX5-8EYR/ES	Supplied from CPU module	—	—	8 points	Relay	92	
FX5-8EYT/ES					Transistor/sink	92	
FX5-8EYT/ESS					Transistor/source	92	
FX5-16EYR/ES		—	—	16 points	Relay	92	
FX5-16EYT/ES					Transistor/sink	92	
FX5-16EYT/ESS					Transistor/source	92	
◆ Input/output module							
FX5-16ER/ES	Supplied from CPU module	8 points	24 V DC sink/source	8 points	Relay	92	
FX5-16ET/ES					Transistor/sink	92	
FX5-16ET/ESS					Transistor/source	92	
◆ High-speed pulse input/output module							
FX5-16ET/ES-H	Supplied from CPU module	8 points	24 V DC sink/source	8 points	Transistor/sink	127	
FX5-16ET/ESS-H					Transistor/source	127	
◆ Powered input/output module							
FX5-32ER/ES	100 to 240 V AC 50/60 Hz	16 points	24 V DC sink/source	16 points	Relay	91	
FX5-32ET/ES					Transistor/sink	91	
FX5-32ET/ESS					Transistor/source	91	
FX5-32ER/DS	24 V DC	16 points	24 V DC sink/source	16 points	Relay	91	
FX5-32ET/DS					Transistor/sink	91	
FX5-32ET/DSS					Transistor/source	91	
■■■ Extension connector type ■■■							
◆ Input module							
FX5-C16EX/D	Supplied from CPU module	16 points	24 V DC sink	—	—	93	
FX5-C16EX/DS			24 V DC sink/source			93	
FX5-C32EX/D		32 points	—	24 V DC sink	—	—	93
FX5-C32EX/DS				24 V DC sink/source			93
FX5-C32EX/DS-TS				93			
◆ Output module							
FX5-C16EYT/D	Supplied from CPU module	—	—	16 points	Transistor/sink	93	
FX5-C16EYT/DSS					Transistor/source	93	
FX5-C16EYR/D-TS		—	—	16 points	Relay	93	
FX5-C32EYT/D		—	—	32 points	Transistor/sink	93	
FX5-C32EYT/DSS					Transistor/source	93	
FX5-C32EYT/D-TS					Transistor/sink	93	
FX5-C32EYT/DSS-TS	Transistor/source				93		
◆ Input/output module							
FX5-C32ET/D	Supplied from CPU module	16 points	24 V DC sink	16 points	Transistor/sink	93	
FX5-C32ET/DSS			24 V DC sink/source		Transistor/source	93	
FX5-C32ET/DS-TS			Transistor/sink		93		
FX5-C32ET/DSS-TS			Transistor/source		93		

◇ Expansion boards, Expansion adapter

Model	Specifications	Description page
FX5-232-BD	For RS-232C communication	157
FX5-485-BD	For RS-485 communication	157
FX5-422-BD-GOT	For GOT connection RS-422 communication	157
FX5-232ADP	For RS-232C communication	158
FX5-485ADP	For RS-485 communication	158
FX5-4A-ADP	2 ch analog input/2 ch analog output adapter	103
FX5-4AD-ADP	4 ch analog input adapter	104
FX5-4AD-PT-ADP	4 ch temperature sensor (resistance temperature detector) input adapter	110
FX5-4AD-TC-ADP	4 ch temperature sensor (thermocouple) input adapter	111
FX5-4DA-ADP	4 ch analog output adapter	104

◇ FX5 extension power supply module, bus conversion module, connector conversion module

Model	Specifications	Description page
FX5-1PSU-5V	FX5UJ, FX5U (AC power supply type) extension power supply	172
FX5-C1PS-5V	FX5U (DC power supply type)/ FX5UC extension power supply	173
FX5-CNV-BUS	Bus conversion FX5 (extension cable type) → FX3	172
FX5-CNV-BUSC	Bus conversion FX5 (extension connector type) → FX3	172
FX5-CNV-IF	Connector conversion FX5 (extension cable type) → FX5 (extension connector type)	173
FX5-CNV-IFC	Connector conversion FX5 (extension connector type) → FX5 (extension cable type)	173

◇ FX5 intelligent function module

Model	Specifications	Description page
FX5-4AD	4 ch analog input	105
FX5-4DA	4 ch analog output	106
FX5-8AD	8 ch multi input	105
FX5-4LC	4 ch temperature control	113
FX5-20PG-P	2-axis pulse train positioning (transistor output)	128
FX5-20PG-D	2-axis pulse train positioning (differential driver output)	128
FX5-40SSC-S	Simple motion 4-axis control	130
FX5-80SSC-S	Simple motion 8-axis control	130
FX5-40SSC-G	Motion 4-axis control	131
FX5-80SSC-G	Motion 8-axis control	131
FX5-ENET	Ethernet module	147
FX5-ENET/IP	EtherNet/IP module	149
FX5-CCL-MS	CC-Link system master/intelligent device station	142
FX5-CCLIEF	Intelligent device station for CC-Link IE Field Network	141
FX5-CCLGN-MS	CC-Link IE TSN master/local module	140
FX5-ASL-M	AnyWireASLINK system master module	153
FX5-DP-M	PROFIBUS-DP master module	156
FX5-OPC	OPC UA module	166

◇ FX3 extension power supply module

Model	Specifications	Description page
FX3U-1PSU-5V	FX3 extension power supply	173

◇ FX3 intelligent function module

Model	Specifications	Description page
FX3U-4AD	4 ch analog input	106
FX3U-4DA	4 ch analog output	107
FX3U-4LC	4 ch temperature control	114
FX3U-1PG	Positioning pulse output 200 kpps	129
FX3U-2HC	2 ch 200 kHz high-speed counter	119
FX3U-16CCL-M	Master for CC-Link V2	144
FX3U-64CCL	Interface for CC-Link V2	145
FX3U-128ASL-M	Master for AnyWireALSINK system	154
FX3U-32DP	PROFIBUS-DP slave	156

◇ Software package

Type	Model	Specifications	Description page
MELSOFT iQ Works (DVD-ROM)	SW2DND-IQWK-E*1	FA engineering software (English version)*2	167
MELSOFT GX Works3 (DVD-ROM)	SW1DND-GXW3-E	PLC engineering software*2 (English version bundled product: GX Works 2, with GX Developer included)	168
MX Component	SW4DNC-ACT-E	ActiveX library for communication (MX Component Ver. 4)	168
	SW5DND-ACT-E	ActiveX library for communication (MX Component Ver. 5)	168
MX Sheet	SW2DNC-SHEET-E	Microsoft® Excel® communication support tool (MX Sheet Ver. 2)	168
	SW3DND-SHEET-E	Microsoft® Excel® communication support tool (MX Sheet Ver. 3)	168
MX Works	SW2DNC-SHEETSET-E	A set of MX Component Ver. 4 and MX Sheet Ver. 2	168
	SW3DND-SHEETSET-E	A set of MX Component Ver. 5 and MX Sheet Ver. 3	168

- *1: If you have a conventional model (SW1DNC-IQWK-E), you cannot update. Please purchase an upgraded version separately. For details, please contact our sales representative.
- *2: For the corresponding models of each software, please refer to the manual of each product.

◇ Communication cable

Model	Specifications	Description page
FX-232CAB-1	3 m 9-pin D-sub (female) ⇔ 9-pin D-sub (female) (for DOS/V, etc.)	177
MR-J3USBCBL3M	3 m CPU module (built-in connector for USB communication) ⇔ personal computer	177
GT09-C30USB-5P	3 m CPU module (built-in connector for USB communication) ⇔ personal computer Made by Mitsubishi Electric System & Service Co., Ltd.	177

◇ Input/output cable

Model	Specifications	Description page	
FX-16E-150CAB	1.5 m	For connection between terminal block and FX5 PLC (Flat cable with connectors at both ends)	
FX-16E-300CAB	3.0 m		
FX-16E-500CAB	5.0 m		
FX-16E-500CAB-S	5.0 m	Loose wire with connector on one end	176
FX-16E-150CAB-R	1.5 m	For connection between terminal block and FX5 PLC (Multi-core round cable with connectors at both ends)	
FX-16E-300CAB-R	3.0 m		
FX-16E-500CAB-R	5.0 m		

◇ Input/output connector

Model	Specifications	Description page
FX2C-I/O-CON	20-pin connector and 10 sets of crimp connector for flat cable	176
FX2C-I/O-CON-S	20-pin connector and 5 sets of housing for loose wire and crimp contact (for 0.3 mm ²)	176
FX2C-I/O-CON-SA	20-pin connector and 5 sets of housing for loose wire and crimp contact (for 0.5 mm ²)	176
A6CON1	40-pin connector, soldered type for external device connection (straight protrusion)	176
A6CON2	40-pin connector, crimped type for external device connection (straight protrusion)	176
A6CON4	40-pin connector, soldered type for external device connection (both straight/inclined protrusion type)	176
FX-I/O-CON2-S	40-pin connector, 2 sets for discrete wire, AWG22 (0.3 mm ²)	176
FX-I/O-CON2-SA	40-pin connector, 2 sets for discrete wire, AWG20 (0.5 mm ²)	176

◇ Terminal block

Model	Specifications	Description page
FX-16E-TB	16 input or output points	175
FX-32E-TB	32 input or output points	175
FX-16E-TB/UL	16 input or output points	175
FX-32E-TB/UL	32 input or output points	175
FX-16EYR-TB	16 relay output points, 2 A/1 point (8 A/4 points)	175
FX-16EYS-TB	16 triac output points, 0.3 A/1 point (0.8 A/4 points)	175
FX-16EYT-TB	16 transistor output points, 0.5 A/1 point (0.8 A/4 points) (sink output)	175
FX-16EYR-ES-TB/UL	16 relay output points, 2 A/1 point (8 A/4 points)	175
FX-16EYS-ES-TB/UL	16 triac output points, 0.3 A/1 point (0.8 A/4 points)	175
FX-16EYT-ESS-TB/UL	16 transistor output points, 0.5 A/1 point (0.8 A/4 points) (source output)	175

◇ Power cable

Model	Specifications	Description page
FX2NC-100MPCB	FX5UC CPU module, for 24 V DC power supply	177
FX2NC-100BPCB	Extension module (extension connector type), for 24 V DC input power supply	177
FX2NC-10BPCB1	Extension module (extension connector type), for 24 V DC input power supply connection wiring	177

◇ Extended cable, connector conversion adapter

Model	Specifications	Description page	
FX5-30EC	30 cm	For the extension of FX5 extension module	174
FX5-65EC	65 cm		174
FX5-CNV-BC	For the connection between an extended extension cable and an FX5 input/output module (extension cable type), a high-speed pulse input/output module, or an FX5 intelligent function module		174

◇ SD memory card, battery

Model	Specifications	Description page
NZ1MEM-2GBSD	SD memory card (2 GB)	171
NZ1MEM-4GBSD	SDHC memory card (4 GB)	171
NZ1MEM-8GBSD	SDHC memory card (8 GB)	171
NZ1MEM-16GBSD	SDHC memory card (16 GB)	171
FX3U-32BL	Battery	171

memo

Global FA Center

Mitsubishi Electric Corporation FA Centers support all our customers and users of MELSEC iQ-F Series all over the world.

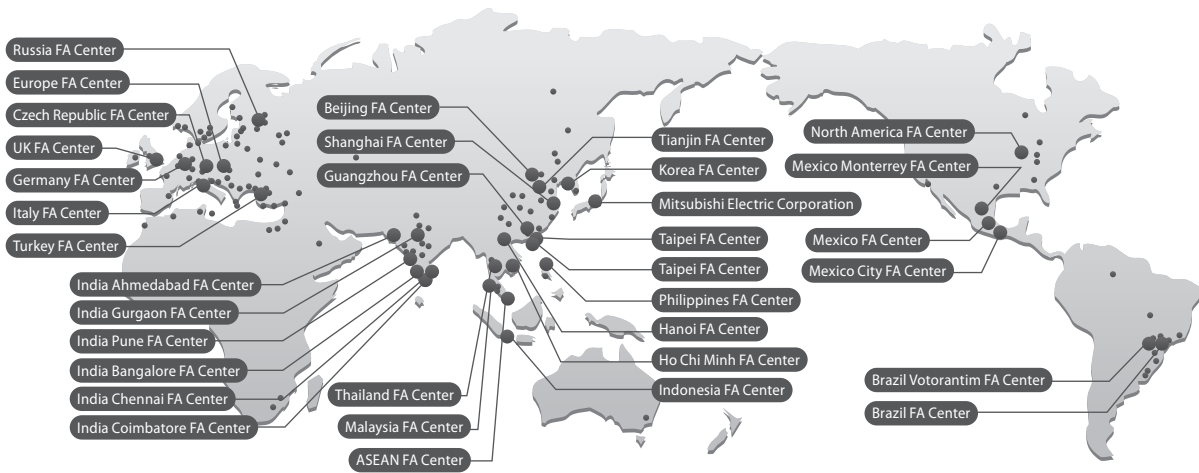

Japan (Tokyo)	FA Global Solution Technical Department	(TEL:+81-3-3218-6422)
Japan (Tokyo)	Asian Business Development Department	(TEL:+81-3-3218-6284)
China (Shanghai)	Mitsubishi Electric Automation (China) Ltd. Shanghai FA Center	(TEL:+86-21-2322-3030)
China (Beijing)	Mitsubishi Electric Automation (China) Ltd. Beijing Branch Beijing FA Center	(TEL:+86-10-6518-8830)
China (Tianjin)	Mitsubishi Electric Automation (China) Ltd. Tianjin Branch Tianjin FA Center	(TEL:+86-22-2813-1015)
China (Guangzhou)	Mitsubishi Electric Automation (China) Ltd. Guangzhou Branch Guangzhou FA Center	(TEL:+86-20-8923-6730)
Taiwan (Taichung)	Mitsubishi Electric Taiwan Co., Ltd.	(TEL:+886-4-2359-0688)
Taiwan (Taipei)	Setsuyo Enterprise Co., Ltd.	(TEL:+886-2-2299-9917)
Korea	Mitsubishi Electric Automation Korea Co., Ltd.	(TEL:+82-2-3660-9632)
ASEAN	MITSUBISHI ELECTRIC ASIA PTE. LTD.	(TEL:+65-6470-2480)
Malaysia	MITSUBISHI ELECTRIC SALES MALAYSIA SDN. BHD.	(TEL:+60-3-7626-5080)
Indonesia	PT. Mitsubishi Electric Indonesia Cikarang Office	(TEL:+62-21-2961-7797)
Vietnam (Hanoi)	Mitsubishi Electric Vietnam Company Limited Hanoi Branch Office	(TEL:+84-4-3937-8075)
Vietnam (Ho Chi Minh)	Mitsubishi Electric Vietnam Company Limited	(TEL:+84-8-3910-5945)
Thailand	Mitsubishi Electric Factory Automation (Thailand) Co., Ltd.	(TEL:+66-2682-6522 to 31)
Philippines	MELCO Factory Automation Philippines Inc.	(TEL:+63-(0)2-8256-8042)
India (Pune)	Mitsubishi Electric India Pvt. Ltd. Pune Branch	(TEL:+91-20-2710-2000)
India (Gurgaon)	Mitsubishi Electric India Pvt. Ltd. Gurgaon Head Office	(TEL:+91-124-463-0300)

India (Bangalore)	Mitsubishi Electric India Pvt. Ltd. Bangalore Branch	(TEL:+91-80-4020-1600)
India (Chennai)	Mitsubishi Electric India Pvt. Ltd. Chennai Branch	(TEL:+91-44-4554-8772)
India (Ahmedabad)	Mitsubishi Electric India Pvt. Ltd. Ahmedabad Branch	(TEL:+91-79-6512-0063)
India (Coimbatore)	Mitsubishi Electric India Pvt. Ltd. Coimbatore Branch	(TEL:+91-422-4385606)
North America	Mitsubishi Electric Automation, Inc.	(TEL:+1-847-478-2469)
Mexico	Mitsubishi Electric Automation, Inc. Queretaro Office	(TEL:+52-442-153-6014)
Mexico (Mexico City)	Mitsubishi Electric Automation, Inc. Mexico Branch	(TEL:+52-55-3067-7511)
Mexico (Monterrey)	Mitsubishi Electric Automation, Inc. Monterrey Office	(TEL:+52-55-3067-7521)
Brazil	Mitsubishi Electric do Brasil Comércio e Serviços Ltda.	(TEL:+55-11-4689-3000)
Brazil (Votorantim)	MELCO CNC do Brasil Comercio e Servicos S.A.	(TEL:+55-15-3023-9000)
Europe	Mitsubishi Electric Europe B.V. Polish Branch	(TEL:+48-12-347-65-00)
Germany	Mitsubishi Electric Europe B.V. German Branch	(TEL:+49-2102-486-0)
UK	Mitsubishi Electric Europe B.V. UK Branch	(TEL:+44-1707-27-8780)
Czech Republic	Mitsubishi Electric Europe B.V. Czech Branch	(TEL:+420-255-719-200)
Italy	Mitsubishi Electric Europe B.V. Italian Branch	(TEL:+39-039-60531)
Russia	Mitsubishi Electric (Russia) LLC St. Petersburg Branch	(TEL:+7-812-633-3497)
Turkey	Mitsubishi Electric Turkey A.S. Umraniye Branch	(TEL:+90-216-526-3990)

About this product catalog

Due to the constantly growing product range and new or changed product features, the information in this catalog may be updated without notice. Please contact your Mitsubishi Electric product provider for more details.

Texts, figures and diagrams shown in this product catalog are intended exclusively for explanation and assistance in planning and ordering the FX5 programmable logic controllers (PLCs) and the associated accessories. Only the manuals supplied with the modules are relevant for installation, commissioning and handling of the modules and the accessories. The information given in the manuals must be read before installation and commissioning of the modules or software.

If any questions arise regarding the application or use of the PLC modules and accessories described in this catalog, please contact your Mitsubishi Electric product provider.

This catalog confers no industrial property rights or any rights of any other kind, nor does it confer any patent licenses. Mitsubishi Electric Corporation cannot be held responsible for any problems involving industrial property rights which may occur as a result of using the contents noted in this catalog.

©2017 MITSUBISHI ELECTRIC CORPORATION

TRADEMARKS

- Anywire and AnyWireASLINK are either registered trademarks or trademarks of Anywire Corporation.
 - Celeron, Intel, and Pentium are either registered trademarks or trademarks of Intel Corporation in the United States and/or other countries.
 - Microsoft, Microsoft Access, ActiveX, Excel, SQL Server, Visual Basic, Visual C++, Visual C# Visual Studio, Windows, Windows NT, Windows Server, Windows Vista, and Windows XP are either registered trademarks or trademarks of Microsoft Corporation in the United States and/or other countries.
 - OPC UA and OPC CERTIFIED logos are registered trademarks of OPC Foundation.
- This product includes software developed by the OpenSSL Project for use in the OpenSSL Toolkit (<http://www.openssl.org/>)
- This product includes software derived from the RSA Data Security, Inc. MD5 Message-Digest Algorithm
- QR Code is either a registered trademark or a trademark of DENSO WAVE INCORPORATED in the United States, Japan, and/or other countries.
 - "YouTube" and YouTube logo mark are either registered trademarks or trademarks of Google LLC.
 - The company names, system names and product names mentioned in this document are either registered trademarks or trademarks of their respective companies.
 - In some cases, trademark symbols such as [™] or [®] are not specified in this document.

YOUR SOLUTION PARTNER

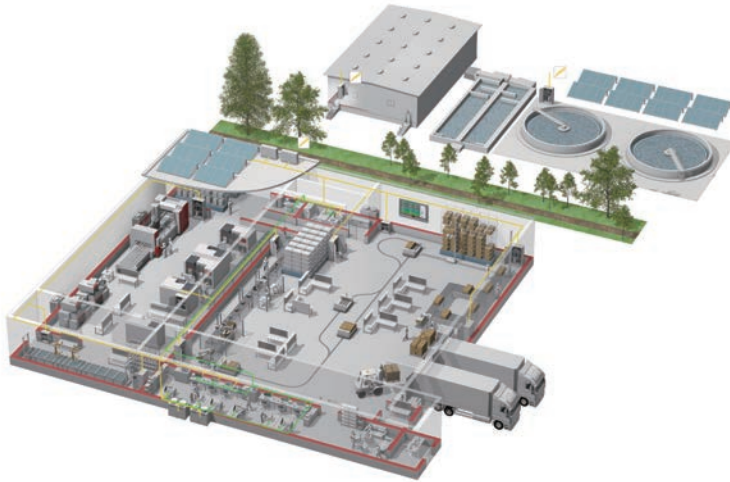

Mitsubishi Electric offers a wide range of automation equipment from PLCs and HMIs to CNC and EDM machines.

A NAME TO TRUST

Since its beginnings in 1870, some 45 companies use the Mitsubishi name, covering a spectrum of finance, commerce and industry.

The Mitsubishi brand name is recognized around the world as a symbol of premium quality.

Mitsubishi Electric Corporation, established in 1921, is active in space development, transportation, semi-conductors, energy systems, communications and information processing, audio visual equipment and home electronics, building and energy management and automation systems, and has 183 factories, laboratories and offices worldwide in over 140 countries.

This is why you can rely on Mitsubishi Electric automation solution - because we know first hand about the need for reliable, efficient, easy-to-use automation and control in our own factories.

As one of the world's leading companies with a global turnover of over 4 trillion Yen (over \$40 billion), employing over 146,000 people, Mitsubishi Electric has the resource and the commitment to deliver the ultimate in service and support as well as the best products.



Low-voltage Power Distribution Products



Transformers, Med-voltage Distribution Products



Power Monitoring and Energy Saving Products



Power (UPS) and Environmental Products



Compact and Modular Controllers



Servos, Motors and Inverters



Visualization: HMIs



Edge Computing Products



Numerical Control (NC)



Collaborative and Industrial Robots

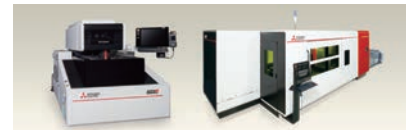

Processing machines: EDM, Lasers

* Not all products are available in all countries.

PROGRAMMABLE CONTROLLERS

MELSEC iQ-F Series

MITSUBISHI ELECTRIC CORPORATION

HEAD OFFICE: TOKYO BLDG., 2-7-3, MARUNOUCHI, CHIYODA-KU, TOKYO 100-8310, JAPAN
www.MitsubishiElectric.com
